

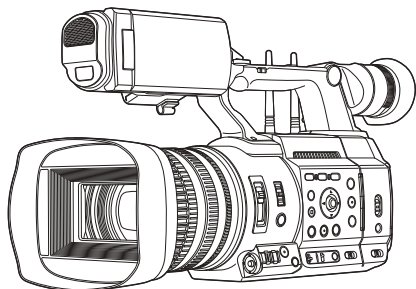

## 4K MEMORY CARD CAMERA RECORDER

# GY-HC550U/GY-HC550E/ GY-HC500U/GY-HC500E/GY-HC500SPCU

## INSTRUCTIONS



## CONNECTED CAM™

Wireless LAN antenna is not included in GY-HC500U/GY-HC500E/GY-HC500SPCU.

The specifications and appearance of this product are subject to changes for further improvement without prior notice.

Please check the latest version of the INSTRUCTIONS from the following Mobile User Guide. You can also download the PDF from the Mobile User Guide.

### Mobile User Guide

When you are outside, you can refer to the instructions from your Android phone or iPhone.

<http://manual3.jvckenwood.com/pro/mobile/global/>

You can view the Mobile User Guide using the browser on your Android phone or iPhone.



#### For Customer Use:

Enter below the Serial No. which is located on the body.  
Retain this information for future reference.

Model No. GY-HC550U/GY-HC500U/GY-HC500SPCU  
Serial No. \_\_\_\_\_

#### Please read the following before getting started:

Thank you for purchasing this product.  
Before operating this unit, please read the instructions carefully to ensure the best possible performance.

In this manual, each model number is described without the last letter (U/E) which means the shipping destination.

(U: for USA and Canada, E: for Europe)  
Only "U" models (GY-HC550U/GY-HC500U/  
GY-HC500SPCU) have been evaluated by UL.



**FOR USA**

**These are general Important Safety Instructions and certain items may not apply to all appliances.**

**Important Safety Instructions**

1. Read these instructions.
2. Keep these instructions.
3. Heed all warnings.
4. Follow all instructions.
5. Do not use this apparatus near water.
6. Clean only with dry cloth.
7. Do not block any ventilation openings. Install in accordance with the manufacturer's instructions.
8. Do not install near any heat sources such as radiators, heat registers, stoves, or other apparatus (including amplifiers) that produce heat.
9. Protect the power cord from being walked on or pinched particularly at plugs, convenience receptacles, and the point where they exit from the apparatus.
10. Only use attachments/accessories specified by the manufacturer.
11. Use only with the cart, stand, tripod, bracket, or table specified by the manufacturer, or sold with the apparatus.  
When a cart is used, use caution when moving the cart/apparatus combination to avoid injury from tip-over.
12. Unplug this apparatus during lightning storms or when unused for long periods of time.
13. Refer all servicing to qualified service personnel.  
Servicing is required when the apparatus has been damaged in any way, such as power-supply cord or plug is damaged, liquid has been spilled or objects have fallen into the apparatus, the apparatus has been exposed to rain or moisture, does not operate normally, or has been dropped.



**For USA-California Only**  
This product contains a CR Coin Cell Lithium Battery which contains Perchlorate Material – special handling may apply.  
See [www.dtsc.ca.gov/hazardouswaste/perchlorate](http://www.dtsc.ca.gov/hazardouswaste/perchlorate)

## POUR LES ÉTATS-UNIS

Ces informations sont des **CONSIGNES DE SÉCURITÉ IMPORTANTES** et certains points peuvent ne pas s'appliquer à tous les appareils.

### CONSIGNES DE SÉCURITÉ IMPORTANTES

1. Lire ces instructions.
2. Conserver ces instructions.
3. Tenir compte de tous les avertissements.
4. Respecter toutes les instructions.
5. Ne pas utiliser cet appareil à proximité de l'eau.
6. Ne nettoyer qu'avec un chiffon sec.
7. Ne pas boucher les ouvertures de ventilation.  
Installer selon les instructions du fabricant.
8. Ne pas installer à proximité de sources de chaleur telles que des radiateurs, des accumulateurs de chaleur, des poêles, ou d'autres appareils (comprenant les amplificateurs) qui produisent de la chaleur.
9. Protéger le cordon d'alimentation pour éviter qu'il ne soit piétiné ou ne se coince, tout particulièrement au niveau de la fiche, de la prise de courant et du point où il sort de l'appareil.
10. Utiliser uniquement des équipements/accessoires spécifiés par le fabricant.
11. N'utiliser qu'avec le chariot, le stand, le trépied, le support ou la table spécifié par le fabricant, ou vendu avec l'appareil.  
Lorsqu'un chariot est utilisé, faire attention pour déplacer la combinaison chariot/appareil pour éviter des blessures causées par un basculement.
12. Débrancher cet appareil pendant un orage ou quand il n'est pas utilisé pendant une longue durée.
13. L'entretien ou la réparation de l'appareil doit être effectué par du personnel qualifié uniquement.  
Un dépannage est nécessaire lorsque l'appareil a été endommagé d'une façon ou d'une autre, telle que lorsque le cordon d'alimentation ou la fiche est endommagé, si du liquide a été renversé ou si des objets sont tombés à l'intérieur de l'appareil, si l'appareil a été exposé à la pluie ou à l'humidité, ne fonctionne pas normalement ou a fait une chute.



#### Pour Californie des États-Unis seulement

Cet appareil contient une pile-bouton CR au lithium qui contient du perchlorate – une manipulation spéciale peut être requise.

Voir [www.dtsc.ca.gov/hazardouswaste/perchlorate](http://www.dtsc.ca.gov/hazardouswaste/perchlorate)

# Safety Precautions

## FOR USA AND CANADA



### CAUTION

RISK OF ELECTRIC SHOCK  
DO NOT OPEN



**CAUTION:**  
TO REDUCE THE RISK OF ELECTRIC SHOCK. DO NOT REMOVE COVER (OR BACK). NO USER-SERVICEABLE PARTS INSIDE. REFER SERVICING TO QUALIFIED SERVICE PERSONNEL.



The lightning flash with arrowhead symbol, within an equilateral triangle is intended to alert the user to the presence of uninsulated “dangerous voltage” within the product’s enclosure that may be of sufficient magnitude to constitute a risk of electric shock to persons.



The exclamation point within an equilateral triangle is intended to alert the user to the presence of important operating and maintenance (servicing) instructions in the literature accompanying the appliance.

## POUR CANADA

### ATTENTION



RISQUE D'ELECTROCUTION  
NE PAS OUVRIR



**ATTENTION:**  
POUR EVITER TOUT RISQUE D'ELECTROCUTION NE PAS OUVRIR LE BOITIER. AUCUNE PIECE INTERIEURE N'EST A REGLER PAR L'UTILISATEUR. SE REFERER A UN AGENT QUALIFIE EN CAS DE PROBLEME.



Le symbole de l'éclair à l'intérieur d'un triangle équilatéral est destiné à alerter l'utilisateur sur la présence d'une “tension dangereuse” non isolée dans le boîtier du produit. Cette tension est suffisante pour provoquer l'électrocution de personnes.



Le point d'exclamation à l'intérieur d'un triangle équilatéral est destiné à alerter l'utilisateur sur la présence d'opérations d'entretien importantes au sujet desquelles des renseignements se trouvent dans le manuel d'instructions.

Ces symboles ne sont utilisés qu'aux Etats-Unis.

## Supplier's Declaration of Conformity

Model Number: GY-HC550U  
 GY-HC500U  
 GY-HC500SPCU

Trade Name: JVC

Responsible Party: JVCKENWOOD USA Corporation

Address: 500 Valley Road,  
 Suite 203 Wayne,  
 NJ 07470

Telephone Number: 973-317-5000

This device complies with Part 15 of the FCC Rules. Operation is subject to the following two conditions: (1) This device may not cause harmful interference, and (2) this device must accept any interference received, including interference that may cause undesired operation.

Changes or modifications not approved by JVC could void the user's authority to operate the equipment. This equipment has been tested and found to comply with the limits for a Class A digital device, pursuant to Part 15 of the FCC Rules. These limits are designed to provide reasonable protection against harmful interference when the equipment is operated in a commercial environment.

This equipment generates, uses, and can radiate radio frequency energy and, if not installed and used in accordance with the instructions, may cause harmful interference to radio communications. Operation of this equipment in a residential area is likely to cause harmful interference in which case the user will be required to correct the interference at his own expense.

## Déclaration de conformité du fournisseur

Numéro de modèle : GY-HC550U  
 GY-HC500U  
 GY-HC500SPCU

Nom de marque : JVC

Personne responsable : JVCKENWOOD USA Corporation

Adresse : 500 Valley Road,  
 Suite 203 Wayne,  
 NJ 07470

Numéro de téléphone : 973-317-5000

Cet ensemble se conforme à la partie 15 des règles de la FCC (Federal Communications Commission). Le fonctionnement est sujet aux deux conditions suivantes : (1) Cet appareil ne peut pas causer d'interférences nuisibles, et (2) cet appareil doit accepter toute interférence reçue, comprenant des interférences qui peuvent causer un mauvais fonctionnement.

Des changements ou modifications non approuvés par JVC peuvent annuler le droit de l'utilisateur de faire fonctionner l'appareil. Cet appareil a été testé et il a été reconnu qu'il se conforme aux limites concernant l'appareillage informatique de classe A correspondant à la partie 15 des règles de la FCC. Ces limites sont conçues pour fournir une protection raisonnable contre les interférences dangereuses lorsque l'équipement est utilisé dans un environnement commercial.

Cet appareil génère, utilise et peut émettre de l'énergie des fréquences radio et, s'il n'est pas installé et utilisé selon les instructions du fabricant, peut causer des interférences nuisibles en communications radio. L'utilisation de cet équipement dans une zone résidentielle est susceptible de causer des interférences néfastes, auquel cas l'utilisateur devra prendre des mesures à ses propres frais.

**CAUTION:**

The mains plug shall remain readily operable.

- Remove the mains plug immediately if the camera functions abnormally.

**WARNING:**

The battery pack, the camera with battery installed, and the remote control with battery installed should not be exposed to excessive heat such as direct sunlight, fire or the like.

**WARNING: TO PREVENT FIRE OR SHOCK HAZARD, DO NOT EXPOSE THIS UNIT TO RAIN OR MOISTURE.**

**NOTES:**

- The rating plate and safety caution are on the bottom and/or the back of the main unit.
- The serial number plate is on the bottom of the unit.
- The rating information and safety caution of the AC adapter are on its upper and lower sides.

**Caution on Replaceable lithium battery**

The battery used in this device may present a fire or chemical burn hazard if mistreated.

Do not recharge, disassemble, heat above 100°C (212°F) or incinerate.

Replace battery with Panasonic, Sanyo, Sony or Maxell CR2025.

Danger of explosion or risk of fire if the battery is incorrectly replaced.

- Dispose of used battery promptly.
- Keep away from children.
- Do not disassemble and do not dispose of in fire.

**Attention:**

La prise secteur doit être opérationnelle.

- Débranchez immédiatement la fiche secteur si le caméscope ne fonctionne pas normalement.

**Avertissement:**

Évitez d'exposer la batterie, le caméscope avec la batterie insérée ou la télécommande avec la batterie insérée à une chaleur excessive, telle que celle des rayons directs du soleil, d'un feu ou de tout autre source de chaleur.

**AVERTISSEMENT : POUR EVITER LES RISQUES D'INCENDIE OU D'ELECTROCUTION, NE PAS EXPOSER L'APPAREIL A LA PLUIE NI A L'HUMIDITE.**

**REMARQUES :**

- La plaque d'identification et l'avertissement de sécurité se trouvent sous l'appareil et/ou au dos.
- La plaque du numéro de série est située sur la partie inférieure de l'appareil.
- Les informations d'identification et l'avertissement de sécurité de l'adaptateur secteur sont situés sur ses côtés supérieur et inférieur.

**Avertissement sur la pile au lithium remplaçable**

La pile utilisée dans cet appareil peut présenter des risques d'incendie ou de brûlure chimique si elle est mal traitée.

Ne pas recharger, démonter, chauffer à plus de 100°C (212°F) ni mettre au feu.

Remplacez la pile avec Panasonic, Sanyo, Sony ou Maxell CR2025.

Danger d'explosion ou risque d'incendie si la pile n'est pas changée correctement.

- Jeter immédiatement les piles usées.
- Placer hors de la portée des enfants.
- Ne pas démonter ni jeter au feu.

When the equipment is installed in a cabinet or on a shelf, make sure that it has sufficient space on all sides to allow for ventilation (10 cm (3-15/16") or more on both sides, on top and at the rear). Do not block the ventilation holes. (If the ventilation holes are blocked by a newspaper, or cloth etc. the heat may not be able to get out.) No naked flame sources, such as lighted candles, should be placed on the apparatus. When discarding batteries, environmental problems must be considered and the local rules or laws governing the disposal of these batteries must be followed strictly.

The apparatus shall not be exposed to dripping or splashing and that no objects filled with liquids, such as vases, shall be placed on the apparatus.

Do not point the lens directly into the sun. This can cause eye injuries, as well as lead to the malfunctioning of internal circuitry. There is also a risk of fire or electric shock.

### **CAUTION!**

The following notes concern possible physical damage to this unit and to the user.

Carrying or holding this unit by the LCD monitor can result in dropping the unit, or in a malfunction.

Do not use a tripod on unsteady or uneven surfaces. It could tip over, causing serious damage to the unit.

### **CAUTION!**

Connecting cables (Audio/Video, etc.) to this unit and leaving it on top of the TV is not recommended, as tripping on the cables will cause the unit to fall, resulting in damage.

Si le matériel est installé dans un coffret ou sur une étagère, s'assurer qu'il y a un espace suffisant sur tous les côtés pour permettre la ventilation (10 cm (3-15/16") ou plus sur les deux côtés, au dessus et à l'arrière).

Ne pas boucher les orifices de ventilation.

(Si les orifices de ventilation sont bouchés par un journal, un tissu, etc., la chaleur peut ne pas s'éliminer.)

Aucune source à flamme nue, telle que des bougies allumées, ne doit être placée sur l'appareil.

En jetant des batteries aux ordures, les problèmes d'environnement doivent être pris en considération et les réglementations locales ou la législation concernant le rebut de ces batteries doivent être strictement respectées.

L'appareil ne doit pas être exposé à de l'eau ou à des éclaboussures et les objets remplis de liquide, tels que des vases, ne doivent pas être placés sur l'appareil.

Ne dirigez pas l'objectif directement vers le soleil. Vous pourriez vous abîmer la vue et l'appareil pourrait être endommagé. Il y a aussi risque d'incendie ou d'électrocution.

### **Attention!**

Les remarques suivantes sont destinées à protéger l'utilisateur et le caméscope contre des dommages éventuels.

Ne pas transporter ou saisir le caméscope par l'écran LCD, car il pourrait tomber ou s'endommager.

Ne pas utiliser de trépied photographique sur des surfaces irrégulières et inclinées. Il pourrait tomber et le caméscope pourrait être sérieusement endommagé.

### **Attention!**

Avec des câbles (Audio/Vidéo, etc.) raccordés, il est recommandé de ne pas laisser le caméscope sur le dessus du téléviseur, car tirer sur les câbles pourrait faire tomber le caméscope, causant des dommages.



**Warning**

This JVC camera generates RF EME while transmitting. RF EME (Radio Frequency Electric & Magnetic Energy) has the potential to cause slight thermal, or heating effects to any part of your body less than the recommended distance from this radio transmitter's antenna. RF energy exposure is determined primarily by the distance to and the power of the transmitting device. In general, RF exposure is minimized when the lowest possible power is used or transmission time is kept to the minimum required for consistent communications, and the greatest distance possible from the antenna to the body is maintained.

The following list provides you with the information required to ensure that you are aware of RF exposure.

- While transmitting, always keep the antenna and the radio at least 5 cm (1-31/32") from your body or face, as well as from any bystanders.
- To maintain compliance with FCC's RF exposure guidelines, use only the supplied antenna (with antenna holder). Unauthorized antenna, modification, or attachments could damage the transmitter and may violate FCC regulations.

**Electromagnetic Interference Compatibility**

Electronic devices are susceptible to electromagnetic interference (EMI) if they are not adequately shielded or designed for electromagnetic compatibility.

Because this product generates RF energy, it can cause interference to such equipment.

- Turn OFF your WLAN where signs are posted to do so. Hospitals and health care facilities use equipment that is sensitive to electromagnetic radiation.
- Turn OFF your product while on board an aircraft when so instructed. Use of the product must be in accordance with airline regulations and/or crew instructions.

**Informations sur la sécurité en présence d'énergie par radiofréquences****Avertissement**

Ce caméscope JVC génère de l'EME par RF lors de la transmission. L'EME par RF (énergie électrique et magnétique par radiofréquences) peut causer de légers effets thermiques ou chauffants sur toute partie de votre corps, lorsque vous trouvez à une distance inférieure à celle recommandée de l'antenne de cet émetteur radio. L'exposition à l'énergie par radiofréquences est principalement déterminée par la distance et la puissance de l'appareil émetteur. En général, l'exposition aux radiofréquences est minimisée lorsqu'on utilise la puissance la plus faible possible ou que le temps de transmission est maintenu au minimum requis pour assurer des communications cohérentes et lorsqu'on maintient la plus grande distance possible entre l'antenne et le corps.

La liste suivante vous fournit les informations dont vous avez besoin pour être sûr d'être informé de l'exposition aux radiofréquences.

- Pendant la transmission, gardez toujours l'antenne et la radio à au moins 5 cm (1-31/32") de votre corps ou de votre visage, ainsi que de toutes les personnes aux alentours.
- Pour maintenir la conformité avec les directives d'exposition RF de la FCC, utilisez uniquement l'antenne fournie (avec support d'antenne). Une antenne, une modification ou des accessoires non autorisés peuvent endommager le transmetteur et enfreindre les réglementations de la FCC.

**Compatibilité aux interférences électromagnétiques**

Les appareils électroniques sont sensibles aux interférences électromagnétiques (EMI) s'ils ne sont pas correctement protégés ou conçus pour une compatibilité électromagnétique.

Étant donné que cet appareil génère de l'énergie par radiofréquences, il peut provoquer des interférences avec ce genre d'équipement.

- Éteignez votre WLAN lorsque des signes vous l'indiquent s'affichent. Les hôpitaux et les établissements de santé utilisent un équipement sensible aux rayonnements électromagnétiques.
- Éteignez votre appareil lorsque vous trouvez à bord d'un avion et qu'on vous le demande. L'utilisation de l'appareil doit être conforme aux règlements de la compagnie aérienne et/ou aux instructions de l'équipage.

**For indoor use only (5150-5250 MHz) in Canada**

There are legal restrictions on the use and outdoor use depending on the country and region. Please be careful not to violate the law.

Data transmission is always initiated by software, which is passed down through the MAC, through the digital and analog baseband, and finally to the RF chip. Several special packets are initiated by the MAC. These are the only ways the digital baseband portion will turn on the RF transmitter, which it then turns off at the end of the packet. Therefore, the transmitter will be on only while one of the aforementioned packets is being transmitted. In other words, this device automatically discontinues transmission in case of either absence of information to transmit or operational failure.

Frequency Tolerance: 20 ppm

This radio transmitter (6549A-W8997M1216) has been approved by Innovation, Science and Economic Development Canada to operate with the antenna types listed below, with the maximum permissible gain indicated. Antenna types not included in this list that have a gain greater than the maximum gain indicated for any type listed are strictly prohibited use with this device.

Antenna type	Gain	Impedance
Dipole	3.6 dBi (4.9-5.8 GHz)	50 Ω
	1.9 dBi (2.4-2.5 GHz)	

**Pour usage intérieur seulement (5150-5250 MHz) au Canada**

Il existe des restrictions légales concernant l'utilisation générale et extérieure en fonction du pays et de la région. Veuillez à respecter la loi.

La transmission des données est toujours initiée par le logiciel, puis les données sont transmises par l'intermédiaire du MAC, par la bande de base numérique et analogique et, enfin à la puce RF. Plusieurs paquets spéciaux sont initiés par le MAC. Ce sont les seuls moyens pour qu'une de la bande de base numérique active l'émetteur RF, puis désactive celui-ci à la fin du paquet. En conséquence, l'émetteur reste uniquement activé lors de la transmission d'un des paquets susmentionnés. En d'autres termes, ce dispositif interrompt automatiquement toute transmission en cas d'absence d'informations à transmettre ou de défaillance.

Tolérance de fréquence: 20 ppm

Le présent émetteur radio (6549 A-W 8997 M 1216) a été approuvé par Innovation, Sciences et Développement économique Canada pour fonctionner avec les types d'antenne énumérés ci-dessous et ayant un gain admissible maximal. Les types d'antenne non inclus dans cette liste, et dont le gain est supérieur au gain maximal indiqué pour tout type figurant sur la liste, sont strictement interdits pour l'exploitation de l'émetteur.

Types d'antenne	Gain	l'impédance
Dipôle	3.6 dBi (4.9-5.8 GHz)	50 Ω
	1.9 dBi (2.4-2.5 GHz)	

This transmitter must not be co-located or operated in conjunction with any other antenna or transmitter.

This device contains licence-exempt transmitter(s)/receiver(s) that comply with Innovation, Science and Economic Development Canada's licence-exempt RSS(s). Operation is subject to the following two conditions:

- ① This device may not cause interference.
- ② This device must accept any interference, including interference that may cause undesired operation of the device.

The available scientific evidence does not show that any health problems are associated with using low power wireless devices. There is no proof, however, that these low power wireless devices are absolutely safe. Low power Wireless devices emit low levels of radio frequency energy (RF) in the microwave range while being used. Whereas high levels of RF can produce health effects (by heating tissue), exposure of low-level RF that does not produce heating effects causes no known adverse health effects. Many studies of low-level RF exposures have not found any biological effects. Some studies have suggested that some biological effects might occur, but such findings have not been confirmed by additional research.

The RF module, W8997-M1216 has been tested and found to comply with FCC/ISED radiation exposure limits set forth for an uncontrolled environment and meets the FCC radio frequency (RF) Exposure Guidelines and RSS-102 of the ISED radio frequency (RF) Exposure rules.

Cet émetteur ne doit pas être co-localisé ou utilisé en conjonction avec une autre antenne ou un autre émetteur.

L'émetteur/récepteur exempt de licence contenu dans le présent appareil est conforme aux CNR d'Innovation, Sciences et Développement économique Canada applicables aux appareils radio exempts de licence. L'exploitation est autorisée aux deux conditions suivantes :

- ① L'appareil ne doit pas produire de brouillage;
- ② L'appareil doit accepter tout brouillage radioélectrique subi, même si le brouillage est susceptible d'en compromettre le fonctionnement.

Les connaissances scientifiques dont nous disposons n'ont mis en évidence aucun problème de santé associé à l'usage des appareils sans fil à faible puissance. Nous ne sommes cependant pas en mesure de prouver que ces appareils sans fil à faible puissance sont entièrement sans danger. Les appareils sans fil à faible puissance émettent une énergie fréquence radioélectrique (RF) très faible dans le spectre des micro-ondes lorsqu'ils sont utilisés. Alors qu'une dose élevée de RF peut avoir des effets sur la santé (en chauffant les tissus), l'exposition à de faibles RF qui ne produisent pas de chaleur n'a pas de mauvais effets connus sur la santé. De nombreuses études ont été menées sur les expositions aux RF faibles et n'ont découvert aucun effet biologique. Certaines études ont suggéré qu'il pouvait y avoir certains effets biologiques, mais ces résultats n'ont pas été confirmés par des recherches supplémentaires.

Le module RF, W8997-M1216 a été testé et jugé conforme aux limites d'exposition aux rayonnements énoncées pour un environnement non contrôlé et respecte les règles des radioélectriques (RF) de la FCC lignes directrices d'exposition et d'exposition aux fréquences radioélectriques (RF) CNR-102 de l'ISDE.

**IMPORTANT (for owners in the U.K.)  
Connection to the mains supply in  
the United Kingdom.  
DO NOT cut off the mains plug from  
this equipment.**

If the plug fitted is not suitable for the power points in your home or the cable is too short to reach a power point, then obtain an appropriate safety approved extension lead or contact the local dealers in your area.

**BE SURE** to replace the fuse only with an identical approved type, as originally fitted, and to replace the fuse cover.

If nonetheless the mains plug is cut off be sure to remove the fuse and dispose of the plug immediately, to avoid possible shock hazard by inadvertent connection to the mains supply.

If this product is not supplied fitted with a mains plug then follow the instructions given below:

**DO NOT** make any connection to the Larger Terminal coded E or Green. The wires in the mains lead are coloured in accordance with the following code:

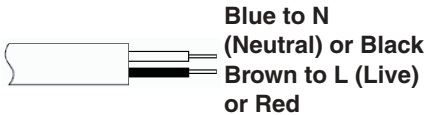

If these colours do not correspond with the terminal identifications of your plug, connect as follows:

Blue wire to terminal coded N (Neutral) or coloured black.

Brown wire to terminal coded L (Live) or coloured Red.

If in doubt — consult a competent electrician.

**CAUTIONS:**

To prevent shock, do not open the cabinet. No user serviceable parts inside. Refer servicing to qualified personnel.

**WARNING**

Operation of this equipment in a residential environment could cause radio interference.

**CAUTION:**

Where there are strong electromagnetic waves or magnetism, for example near a radio or TV transmitter, transformer, motor, etc., the picture and the sound may be disturbed. In such case, please keep the apparatus away from the sources of the disturbance.

The plastics packaging bags may cause suffocation when they are covered over the head. Tear them open, and keep them away from the reach of infants and children by ensuring that they are disposed of properly.

**GY-HC550E**

**Wireless LAN**

- This device is a 2.4 GHz wideband transmission system (transceiver), intended for use in all EU member states and EFTA countries, except in France and Italy where restrictive use applies.
- In Italy the end-user should apply for a license at the national spectrum authorities in order to obtain authorization to use the device for setting up outdoor radio links and/or for supplying public access to telecommunications and/or network services.
- This device may not be used for setting up outdoor radio links in France and in some areas the RF output power may be limited to 10 mW EIRP in the frequency range of 2454 - 2483.5 MHz. For detailed information the end-user should contact the national spectrum authority in France.

Frequency Range	2.4GHz Band : 1 - 13ch
Output Power	11 b/g/n : 14 dBm (max)

Frequency Range	5GHz Band : W52/W53/W56
Output Power	11 n/a/ac : 11 dBm (max)

## GY-HC550E and GY-HC500E

The European representative of JVCKENWOOD Corporation is:

Die europäische Vertretung für die JVCKENWOOD Corporation ist:

JVCKENWOOD Deutschland GmbH  
Konrad-Adenauer-Allee 1-11  
61118 Bad Vilbel  
GERMANY

### GY-HC500E

Dear customer,  
this apparatus is in compliance with the valid European Directive and the relevant standards regarding electromagnetic compatibility.

Sehr geehrter Kunde, sehr geehrte Kundin,  
dieses Gerät stimmt mit der gültigen europäischen Richtlinie und den relevanten Normen bezüglich elektromagnetischer Verträglichkeit überein.

### GY-HC550E

Hereby, JVCKENWOOD Corporation declares that the radio equipment type GY-HC550E is in compliance with Directive 2014/53/EU.  
The full text of the EU declaration of conformity is available at the following internet address:

Hiermit erklärt die , JVCKENWOOD Corporation, dass der Funkanlagentyp GY-HC550E der Richtlinie 2014/53/EU entspricht.  
Der vollständige Text der EU-Konformitätserklärung ist unter der folgenden Internetadresse verfügbar:



<http://www3.jvckenwood.com/ecdoc/>

## Battery Pack

The supplied battery pack is a lithium-ion battery. Before using the supplied battery pack or an optional battery pack, be sure to read the following cautions:

- **To avoid hazards**
  - ... **do not** burn.
  - ... **do not** short-circuit the terminals. Keep it away from metallic objects when not in use.
  - When transporting, carry the battery in a plastic bag.
  - ... **do not** modify or disassemble.
  - ... **do not** expose the battery to temperatures exceeding 60°C (140°F), as this may cause the battery to overheat, explode or catch fire.
  - ... use only specified chargers.
- **To prevent damage and prolong service life**
  - ... do not subject to unnecessary shock.
  - ... charge within the temperature range of 10°C to 35°C (50°F to 95°F). Cooler temperatures require longer charging time, or in some cases stop charging at all. Warmer temperatures prevent complete charging, or in some cases stop charging at all.
  - ... store in a cool, dry place. Extended exposure to high temperatures will increase natural discharge and shorten service life.
  - ... keep a 30% battery level () if the battery pack is not to be used for a long period of time.
  - ... remove from charger or powered unit when not in use, as some machines use current even when switched off.
  - ... do not drop or subject to strong impact.

### Terminals

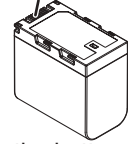

## ■ Para Brasil

### Informação sobre eliminação de baterias

Este produto não deverá ser eliminado como lixo doméstico em geral.

Devolva a bateria velha ao comerciante ou para a rede autorizada, para que seja devolvida ao fabricante ou importador.

A reciclagem e eliminação de lixo em uma maneira adequada, ajudarão para preservar recursos, prevenindo, ao mesmo tempo, contra efeitos prejudiciais sobre a nossa saúde e o meio ambiente.

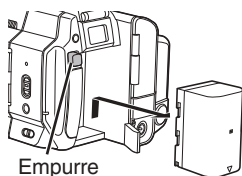

# Contents

## Introduction

Safety Precautions .....	5
Contents .....	15
Main Features .....	18
Precautions for Proper Use .....	20
Operation Modes .....	24
Names of Parts .....	26
Side Control Panel .....	28
Rear Terminal .....	30
LCD Monitor .....	31
Lens Section .....	31
Basic System Diagram .....	32

## Preparations

Settings and Adjustments Before Use .....	33
Adjusting the Grip Belt .....	33
Attaching the External Microphone (Sold Separately) .....	33
Opening/Closing the Lens Cover .....	33
Attaching the Tripod (Sold Separately) .....	33
Attaching the Wireless LAN Antennas (Supplied) <b>550</b> .....	34
Attaching/Detaching the Hood .....	34
Power Supply .....	35
Using a Battery Pack .....	35
Using AC Power (DC IN Power) .....	36
Power Status Display .....	37
Turning On/Off the Power .....	38
Initial Settings .....	39
Displays on the LCD Monitor and Viewfinder ..	41
Display Screen .....	41
Status Screen .....	42
Remote Edit Mode Screen .....	42
Warning Display .....	42
Adjusting the LCD Monitor and Viewfinder .....	43
Adjusting the LCD Monitor .....	43
Adjusting the Viewfinder .....	44
Assignment of Functions to User Buttons .....	46
Tally Lamp and LED .....	47
Recording Media .....	48
Usable Cards .....	48
Usable SSD Media .....	48
Estimated Recordable Time of SD Cards ..	48
Estimated Recordable Time of SSD Media ..	49
Inserting an SD Card .....	50
Removing the SD Card .....	50
Switching the SD cards .....	51
Inserting the SSD Media Adapter .....	51
Formatting (Initializing) of Recording Media .	51
Repairing the Recording Media .....	52

Clips Recorded to Recording Media .....	53
About the Operation Lock Feature (KEYLOCK) .....	54

## Shooting

Basic Shooting Procedures .....	55
Selecting System Definition, File Format and Video Format .....	56
Zoom Operation .....	59
Focus Operation .....	60
Adjusting the Focusing by Face Detection .....	62
Adjusting the Brightness .....	64
Adjusting the Iris .....	65
Setting the Gain .....	66
Setting the Electronic Shutter .....	67
Setting the ND Filter .....	68
Adjusting the White Balance .....	69
Adjusting the Camera Image .....	73
Using the Image Stabilizer .....	73
Audio Recording .....	74
Monitoring Audio Sound During Recording Using a Headphone .....	76
Time Code and User's Bit .....	76
Setting Time Code Generator .....	77
Setting the User's Bit .....	80
Synchronizing Time Code on Another Camera .....	81
Setting Zebra Pattern .....	82
Setting Spot Meter .....	83
Acquiring Positioning Information by GPS <b>550</b> <b>SPC</b> .....	85
Viewing Recorded Videos Immediately (Clip Review) .....	86
Displaying the Histogram .....	87
Recording Simultaneously at Two Different Definitions .....	87
Series Rec .....	87
Dual Rec .....	88
Backup Rec .....	89
Special Recording .....	91
Pre Rec .....	91
Clip Continuous Rec .....	92
Frame Rec .....	94
Interval Rec .....	95
Splitting the Clips Freely (Clip Cutter Trig) .....	96
Configuring Infrared Recording .....	96

**Playback**

Playing Recorded Clips .....	97
Thumbnail Screen .....	97
Actions .....	99
Playing back .....	100
Deleting Clips .....	102
Appending/Deleting OK Mark .....	103
Selecting and Performing Operations on Multiple Clips .....	104
Selecting Multiple Clips Randomly .....	104
Selecting Multiple Clips Consecutively .....	105
Trimming Recorded Clips .....	106

**Menu Display and Detailed Settings**

Basic Operations in Menu Screen .....	107
Display and Description of the Menu Screen .....	108
Text Input with Software Keyboard .....	109
Menu Screen Hierarchical Chart .....	110
Camera Function Menu .....	111
Zoom Function Settings .....	113
Focus Function Settings .....	114
Face Detection Function Settings .....	115
User Switch Set Item .....	116
Camera Process Menu .....	118
White Balance Item .....	123
TC/UB Menu .....	124
LCD/VF Menu .....	125
Shooting Assist Item .....	126
Marker Settings Item .....	127
Display Type Item .....	128
Display On/Off Item .....	129
A/V Set Menu .....	130
Video Set Item .....	130
Audio Set Item .....	132
Network Menu .....	135
Connection Setup Item .....	136
Live Streaming Item .....	137
Return over IP Item .....	139
Web Item .....	141
Metadata Server Item .....	142
Upload Settings Item .....	142
Overlay Settings Menu <b>550 SPC</b> .....	144
Settings Item <b>SPC</b> (Sportzcast) .....	146
System Menu .....	147
Record Set Item .....	149
Adding/Editing Frequently Used Menu Items (Favorites Menu) .....	155
Adding Menu Items to Favorites Menu .....	155
Editing Favorites Menu .....	156

**Display/Status Screen**

Display Screen in Camera Mode .....	159
Display Screen in Media Mode .....	165
Status Screen .....	167

**Camera Features**

Marker and Safety Zone Displays (Camera Mode Only) .....	169
Color Bar Output .....	169
Adjusting the Gamma .....	170
Adjusting Color Matrix .....	171
Configuring Setup Files .....	172
Saving Setup Files .....	173
Loading a Setup File .....	174
Deleting Setup Files .....	174

**Connecting External Devices**

Connecting External Monitor .....	175
Connect the headphone. ....	176
Connecting Wired Remote Control .....	176

**Network**

Functions of Network Connection .....	177
Preparing Network Connection .....	178
Operating Environment .....	178
Camera Setup for Network Connection .....	178
Connecting to the Network .....	179
Importing Metadata .....	180
Preparing Metadata .....	180
Configuring the Server for Downloading .....	181
Importing Metadata .....	181
Uploading a Recorded Video Clip .....	182
Configuring the FTP Server for Uploading .....	182
Uploading Clips Automatically (Auto FTP) .....	183
Uploading Clips Manually (Manual FTP) .....	183
FTP Resume Feature .....	186
Connecting from a Web Browser .....	186
Editing Metadata .....	187
Planning Metadata .....	187
Clip Metadata .....	188
Uploading a Recording Clip via a Web Browser .....	190
View Remote Feature .....	194
Operating Procedure .....	194
Registering/Deleting Preset Zoom .....	195
Camera Control Function .....	196
Changing the Settings via a Web Browser .....	198
Changing View Remote Function Settings .....	199
Changing Connection Setup .....	199
Changing Metadata Server Settings .....	200
Changing Clip Server Settings .....	200
Changing Streaming Settings .....	200
Managing the Network Connection Settings File .....	201



Saving the Connection Settings File .....	201
Reading the Connection Settings File .....	202
Deleting Connection Settings .....	203
Performing Live Streaming .....	204
Setting Distribution .....	206
Starting Distribution .....	208
Setting the FEC Matrix .....	209
Return Video/Audio from the Network (Return over IP) .....	210
IFB (Return Audio) .....	211
Tagging Feature <b>SPC</b> .....	212
Configuring to Exchange Format .....	212
Configuring Camera Angle Information .....	212
Entering Tag Information .....	212
Synchronizing GPS Time Code .....	213
<b>Overlay</b> <b>550</b> <b>SPC</b> .....	
Broadcast Overlay <b>550</b> <b>SPC</b> .....	214
Importing and Configuring Settings for SDP Files for Broadcast .....	214
Displaying Watermark Images .....	216
Displaying Images on the Whole Screen (Full Screen Graphic Function) .....	216
Protecting Overlay Settings with a Password .....	218
Specifying Text and Images .....	219
Scoreboard Overlay <b>SPC</b> .....	219
Configuring Scoreboard Display .....	219
Configuring Scoreboard Display Position ..	220
Entering Scoreboard Data .....	221
Team Display Settings .....	228
Entering Scoreboard Data Automatically ...	229
<b>Others</b>	
Error Messages and Actions .....	231
List of FTP Transfer Errors .....	232
List of Live Streaming Error Displays .....	234
List of Layout Import Error Displays <b>550</b> <b>SPC</b> .....	235
List of Sportzcast Connection Error Displays <b>SPC</b> .....	235
Blinking of the Tally Lamp .....	236
Warning Tone .....	236
Troubleshooting .....	237
Specifications .....	239
Appendix .....	245
Index .....	246
Software License Agreement .....	248
Important Notice concerning the Software .....	249

# Main Features

## 1" CMOS sensor and new 4K 20x lens for high-quality recording

Comes with a 1" CMOS sensor that delivers high resolution and an excellent S/N ratio. At the same time, a new 4K 20x lens with a good balance in viewing angle, image quality and magnification is employed to reduce the occurrence of aberrations, thereby achieving premium-quality 4K recording with high sensitivity and low noise.

## "Apple ProRes 422" available as a standard feature to achieve high-resolution and high bit-rate recording performance

By making use of the KA-MC100 SSD media adapter (sold separately), it is possible to perform 4K 50p/60p Apple ProRes 422 recording to a high-speed SSD memory.

## A variety of wired and wireless interfaces to support various network connections

In addition to the USB host terminal for wireless LAN and LTE USB adapter connections, this camera recorder is equipped with a variety of interfaces such as wired LAN terminal and built-in wireless LAN with 2.4GHz/5GHz MIMO dual band antennas **550** to support various network connections.

## Bidirectional live streaming feature

Enables live streaming broadcast from the camera, while at the same time receives program images from studio stations as IP return video or intercom audio as IP return audio (IFB) over the same line.

## High quality signal processing by 10-bit, 4:2:2 sampling

High quality signal processing that delivers rich gradation expression and color reproduction of video signals is possible by means of 10-bit, 4:2:2 sampling.

## Various usage-based recording formats

Recording codecs supported are MPEG-4 AVC/H.264 and Apple ProRes 422, which is compatible with 4:2:2 10-bit recording. Selectable ProRes formats include Apple ProRes 422HQ, Apple ProRes 422 and Apple ProRes 422LT. Selectable MPEG-4 AVC/H.264 formats include QuickTime (MOV) and MP4.

It is also compatible with MPEG2 MXF, which is a widely-used format at broadcasting stations. **550**

## HDR and log gamma for high dynamic range and wide color gamut

This camera recorder is equipped with HLG (Hybrid Log-Gamma) that conforms to ITU-BT.2100 and our in-house J-Log1 Gamma with 800% dynamic range to cope with HDR (High Dynamic Range). Capable of recording in 10-bit for high dynamic range and wide color gamut.

## High-frame-rate recording in Full HD quality (1920x1080)

Videos with a maximum frame rate of 120 fps can be recorded in slow motion. It can be used to check the style of the subject in fast-moving sports and in video expression that leaves a deep impression.

## Broadcast Overlay **550** **SPC**

Station name, program name, or news title according to the recorded content can be entered easily by using a smartphone or tablet, and this information can be superimposed on the recording clip or streaming images.

Also, it comes with a full-screen graphic feature that allows overlay of the entire screen with images such as notifications and advertisements.

## Score Board Overlay **SPC**

Allows display of scores for games such as football, baseball, basketball and hockey over the video image.

Scores can be entered from a smartphone or tablet while video-shooting is in progress, enabling easy operation such as live broadcast by a small crew.

## Auto focus/optical image stabilizer (OIS)

The camera recorder is equipped with a face detection auto focus function that covers the entire screen. Switching to manual focus is also possible. A built-in optical image stabilizer feature is also available.

## Prevents camera shake with the OIS hard lock feature

Helps to secure the OIS lens to prevent unnatural video images due to sudden acceleration of vehicles when the camera is mounted on a vehicle.

## Double SD card slots for series/dual recordings

The most common SDHC/SDXC card recording system is used for the memory card. This ensures high reliability and operation at low running cost. Various user friendly recording options are available. These include series recording which enables seamless long hour continuous recordings over the slots and dual recording of the same file to two slots.

## FTP feature that supports automatic upload

Clips stored in the recording media can be uploaded automatically to the FTP server while recording is paused. When recording is in progress, clips stored in the slot that is not used for recording can also be uploaded.

## Large tricolor LED indicators that show the camera and network status

The two large LED indicators light up in three different colors to allow identification of the camera status and network status (including the return video) at a glance.

## Time code input/output terminals for shooting using multiple cameras

This camera recorder supports the use of multiple cameras as well as studio use.

## Professional-style switch layout and diverse video parameters

Switches for Gain and White Balance are available on the side panel to enable quick switching according to the shooting scene. Image quality parameters such as gamma and color matrix are also available in the menu for adjustment to the preferred tones.

## Built-in GPS **550** **SPC**

This camera recorder is built in with GPS function, which enables the positional information obtained from the GPS satellite during a shoot to be recorded as metadata.

\* Note that acquisition of the positional information may fail depending on the weather condition.

## User buttons/switches assignable with different functions for greater ease of use

Menu items corresponding to each user button are available to assign the buttons with different functions.

## Symbols used

- Caution** : Describes precautions concerning the operation of this product.
- Memo** : Describes reference information, such as functions and usage restrictions of this product.
-  : Indicates the reference page numbers and reference items.
- 550** : Feature available on GY-HC550U/GY-HC550E only.
- 500** : Feature available on GY-HC500U/GY-HC500E/GY-HC500SPCU only.
- SPC** : Feature available on GY-HC500SPCU only.

## Content of this manual

- All rights reserved by JVCKENWOOD Corporation. Unauthorized duplication or reprinting of this manual, in whole or in part, is strictly prohibited.
- Illustrated designs, specifications and other contents of this manual are subject to change for improvement without prior notice.
- SDXC and SDHC logos are trademarks of SD-3C, LLC.
- The terms HDMI and HDMI High-Definition Multimedia Interface, and the HDMI Logo are trademarks or registered trademarks of HDMI Licensing Administrator, Inc. in the United States and other countries.
- QuickTime, Final Cut Pro, iPhone, iPad, iPod touch, macOS and Safari are trademarks of Apple Inc., registered in the U.S. and other countries.
- iOS is a trademark or registered trademark of Cisco in the U.S. and other countries and is used under license.
- Android and Google Chrome are trademarks and/or registered trademarks of Google LLC.
- QR Code is a registered trademark of Denso Wave Incorporated.
- Microsoft, Windows, and Internet Explorer are either registered trademarks or trademarks of Microsoft Corporation in the United States and/or other countries.
- The company name of Fontworks, Fontworks, and the name of the fonts are registered trademarks of Fontworks Inc.
- Zixi and the Zixi logo are trademarks of Zixi LLC.
- Other product and company names included in this instruction manual are trademarks and/or registered trademarks of their respective companies. Marks such as ™ and ® have been omitted in this manual.

# Precautions for Proper Use

## Storage and Usage Locations

- Allowable ambient temperature and humidity  
Be sure to use this unit within the allowable temperature range of 0 °C to 40 °C (32 °F to 104°F) and a relative humidity of 30 % to 80 %. Using this unit at a temperature or humidity outside the allowable ranges could result not only in malfunction but also serious impact on the CMOS elements as small white spots may be generated. Please exercise care during use.
- Strong electromagnetic waves or magnetism  
Noise may appear in the picture or audio and/or the colors may be incorrect if this unit is used near a radio or television transmitting antenna, in places where strong magnetic fields are generated by transformers, motors, etc., or near devices emitting radio waves, such as transceivers or cellular phones.
- Use of wireless microphone near this unit  
When a wireless microphone or wireless microphone tuner is used near this unit during recording, the tuner could pick up noise.
- Avoid using or placing this unit in the following places.
  - Places subject to extreme heat or cold
  - Places with excessive dirt or dust
  - Places with high humidity or moisture
  - Places subject to smoke or vapor such as near a cooking stove
  - Places subject to strong vibrations or unstable surfaces
  - In a parked car under direct sunlight or near a heater for long hours
- Do not place this unit at places that are subject to radiation or X-rays, or where corrosive gases occur.
- Protect this unit from being splashed with water. (Especially when shooting in the rain)
- Protect this unit from getting wet when shooting on a beach. In addition, salt and sand may adhere to the body. Be sure to clean the unit after use.
- Protect this unit against penetration of dust when using it in a place subject to sandy dust.

## Carrying the Camera

- Do not drop or hit this unit against a hard object when transporting.

## Power Saving

- When this unit is not in use, be sure to set the [POWER ON/OFF] switch to “OFF” in order to reduce power consumption.

## Maintenance

- Turn off the power before performing any maintenance.
- Wipe the external cabinet of the unit with a soft cloth. Do not wipe the body with benzene or thinner. Doing so may cause the surface to melt or turn cloudy. When it is extremely dirty, soak the cloth in a solution of neutral detergent, wipe the body with it, and then use a clean cloth to remove the detergent.

## Rechargeable Battery

- Be sure to use only the specified batteries.  
We do not guarantee the safety and performance of this device if an unspecified battery is used.
- Store the battery in a cool and dry place when not in use. Do not expose the battery to high temperatures (such as in a car under direct sunlight). Failure to do so not only shortens the battery life but also damages the battery.
- Charge the battery first before using.
- If you are not using the battery for a prolonged period of time, remove and keep the battery at a 30 % to 40 % charge level to prevent deterioration.
- Recharge the battery to a level of 10 % to 20 % once every six months when storing the battery. Storing the battery at a fully discharged state will result in over discharging and inability to charge the battery.
- **ATTENTION:**



The product you have purchased is powered by a rechargeable battery that is recyclable. Please call 1-800-8-BATTERY for information on how to recycle this battery.

## Regular Inspection (Maintenance)

- Under normal environment, dust will accumulate on the camera recorder when it is used over a long period. Dust may enter the camera recorder especially if it is used outdoors. This may affect the image and sound quality of the camera recorder. Check and replace the fan after every 9000 hours (suggested guideline). You can check the usage time of the fan in [System] ➔ [System Information] ➔ [Fan Hour]. (☞ P149 [ Fan Hour ] )  
If the fan is used for more than 9000 hours without replacement, "Fan Maintenance Required" will be displayed every time you turn on the power.

## SDHC/SDXC Cards

- SDHC/SDXC card is referred to as "SD card" or "recording media" in this manual.
- This camera recorder saves the recorded images and audio sound on the SD card (sold separately) in the card slot.
- If the SD card contains files recorded by devices other than this camera recorder or files that are saved from a PC, the recordable time may be shorter or data may not be properly recorded. In addition, the remaining space on the card may not increase even when files are deleted using a PC.
- For details on the combinations of usable SD card and format setting, refer to the following. (☞ P48 [Format Setting and Usable SD Card Combinations] )

\* Using cards other than those from Panasonic, TOSHIBA or SanDisk may result in recording failure or data loss.

## Handling of SD Cards

- The status indicator lights up in red when data on the SD card is being accessed. Do not remove the SD card during data access (such as recording, playback, or formatting). Do not turn off the power or remove the battery and AC adapter during access either.
- Do not use or store the SD card in a place that is subject to static electricity or electrical noise.
- Do not place the SD card near locations that are exposed to strong magnetic fields or radio waves.
- Inserting the SD card incorrectly may result in damage of this unit or the SD card.
- We are not liable for any accidental loss of data stored on the SD card. Please back up any important data.

- Make use of the SD card within the prescribed conditions of use. Do not use it at the following locations. Places that are subject to direct sunlight, high humidity or corrosion, places near thermal equipment, sandy or dusty places, or in a car under the sun with the doors and windows closed.
- Do not bend or drop the SD card, or subject it to strong impact or vibration.
- Do not splash the SD card with water.
- Do not dismantle or modify the SD card.
- Do not touch the terminals with your hands or with a metal object.
- Do not allow dust, dirt, water, or foreign objects to adhere to the terminals.
- Do not remove the labels or stick other labels or stickers on the SD cards.
- Do not use pencils or ballpoint pens to write on the SD cards. Always use oil-based pens.
- If you format (initialize) the SD card, all data recorded on the card, including video data and setup files, will be deleted.
- You are recommended to use cards that are formatted (initialized) on this camera recorder.
  - The SD card may be damaged if the camera recorder is not operated correctly. Formatting (Initializing) the SD card may allow it to operate correctly.
  - SD cards that have been formatted (initialized) on other cameras, computers or peripheral equipment may not operate correctly. In this case, format (initialize) the SD card on this camera recorder.

- If you want to wipe out all information by completely erasing the data, we recommend either using commercially available software that is specially designed for that purpose, or by physically destroying the SD card with a hammer, etc. When formatting or erasing data using the camera recorder, only the file administration information is changed. The data is not completely erased from the SD card.
- Some commercially available SD cards may be harder to be removed from this unit. Remove them by hooking onto the groove on the cards.
  - It will be easier to remove the cards after several times.
  - Do not stick any stickers on the cards.



- The SD card may pop out when it is being removed. Be careful not to lose the card.

## Encryption in Network Connection

- Wireless LAN connections make use of an encryption function. This encryption is designed for commercially-sold equipment, and it cannot be altered.

## LCD Monitor and Viewfinder

- The LCD monitor and viewfinder screen are manufactured using high-precision technology. Black or bright spots may appear on the LCD monitor and viewfinder screen. This is not a malfunction. These spots will not be recorded.
- If you use this unit continuously for a long period of time, the characters displayed in the viewfinder may temporarily remain on the screen. This phenomenon will not be recorded to the recording media. They will not appear after you turn the power off and then on again.
- If you use this unit in a cold place, the images may appear to lag on the screen, but this is not a malfunction. Retained images are not recorded on the SD card.
- Do not press against the surface with force or subject it to strong impact. Doing so may damage or break the screens.
- Noise may appear in the viewfinder when switching between the live video and playback images.
- Due to the characteristic of the viewfinder display device, colors may appear on the images when you blink your eyes. It does not affect the recorded images, SDI output, or HDMI output.

## GPS 550 SPC

- The GPS (Global Positioning System) satellites are managed by the Department of State of the U.S., and its precision may be altered intentionally.
- Perform positioning at an unobstructed location with a clear view that is not indoors or blocked by trees.
- The time needed for obtaining the position information may be longer and variation may also be larger depending on the surrounding environment and time of day.
- This camera recorder uses the WGS 84 World Geodetic System.
- Signal from GPS satellites may be interrupted by communication signal from electronic devices such as mobile phones.
- Make use of it in accordance with the regulations of the country, region or location of use.

## Copyright

- Any recordings made on this camera recorder that are played back for profit or public preview may infringe on the rights of the owner of the recordings. Do not use the recordings for purpose other than personal enjoyment without prior consent from the owner. And even for personal enjoyment, you may not be able to record without permission from the owner.

## License Notices

- MPEG LA AVC  
THIS PRODUCT IS LICENSED UNDER THE AVC PATENT PORTFOLIO LICENSE FOR THE PERSONAL USE OF A CONSUMER OR OTHER USES IN WHICH IT DOES NOT RECEIVE REMUNERATION TO  
(i) ENCODE VIDEO IN COMPLIANCE WITH THE AVC STANDARD ("AVC VIDEO") AND/OR  
(ii) DECODE AVC VIDEO THAT WAS ENCODED BY A CONSUMER ENGAGED IN A PERSONAL ACTIVITY AND/OR WAS OBTAINED FROM A VIDEO PROVIDER LICENSED TO PROVIDE AVC VIDEO. NO LICENSE IS GRANTED OR SHALL BE IMPLIED FOR ANY OTHER USE. ADDITIONAL INFORMATION MAY BE OBTAINED FROM MPEG LA, L.L.C. SEE [HTTP://WWW.MPEGLA.COM](http://www.mpegla.com)
- MPEG LA MPEG-2 Patent  
ANY USE OF THIS UNIT IN ANY MANNER OTHER THAN PERSONAL USE THAT COMPLIES WITH THE MPEG-2 STANDARD FOR ENCODING VIDEO INFORMATION FOR PACKAGED MEDIA IS EXPRESSLY PROHIBITED WITHOUT A LICENSE UNDER APPLICABLE PATENTS IN THE MPEG-2 PATENT PORTFOLIO, WHICH LICENSE IS AVAILABLE FROM MPEG LA, LLC, 6312 S. FIDDLERS GREEN CIRCLE, SUITE 400E, GREENWOOD VILLAGE, COLORADO 80111 U.S.A.

## Rebooting

- The camera recorder is rebooted when the following operations are performed.
  - [System] → [Record Set] → [Record Format]
  - [System] → [Record Set] → [Time Stamp]
  - [System] → [Setup File] → [Load File] → [User File]/[All File]
  - [System] → [Reset All]
  - [Camera Process] → [Reverse Picture]
  - [Network] → [Return over IP] → [Function]
  - [Overlay Settings] → [Overlay Function] **550**
  - **SPC**
  - [Overlay Settings] → [Output] **550** **SPC**

## Others

- Do not insert objects other than the memory card into the card slot.
- Do not block the vent on the unit. Blocking of the vent causes internal heating and may lead to burns and fires.
- Hot air may be discharged from the vents depending on the condition of use. This is not a malfunction.
- Do not turn off the [POWER ON/OFF] switch or remove the power cable during recording or playback.
- The camera recorder may not show stable pictures for a few seconds immediately after the power is turned on, but this is not a malfunction.
- When the video signal output terminals are not in use, put on the covers to prevent damage to the terminals.
- Do not drop this unit or subject it to strong impact or vibration as it is a precision equipment.
- Optical performance of lens  
Due to the optical performance of the lens, color divergence phenomena (magnification chromatic aberration) may occur at the periphery of the image. This is not a camera malfunction.
- Noise may appear in the image when switching modes.
- If placed on its side, heat release efficiency will deteriorate.
- Use the supplied AC adapter as the power supply. Do not use the supplied AC adapter on other devices.
- Use the supplied power cord. And do not use the supplied power cord for any other devices.
- When the connectors that come with connector covers are not in use, put on the covers to prevent damage to the connectors.
- This camera recorder makes use of fonts by Fontworks Inc.
- This camera recorder makes use of M+ FONTS.
- Use the built-in wireless LAN only in the country and region where it was purchased. And there are legal restrictions on the use and outdoor use depending on the country and region. Please be careful not to violate the law.

**550**

# Operation Modes

This camera recorder has three operation modes - Camera mode, Media mode, and Remote Edit mode.

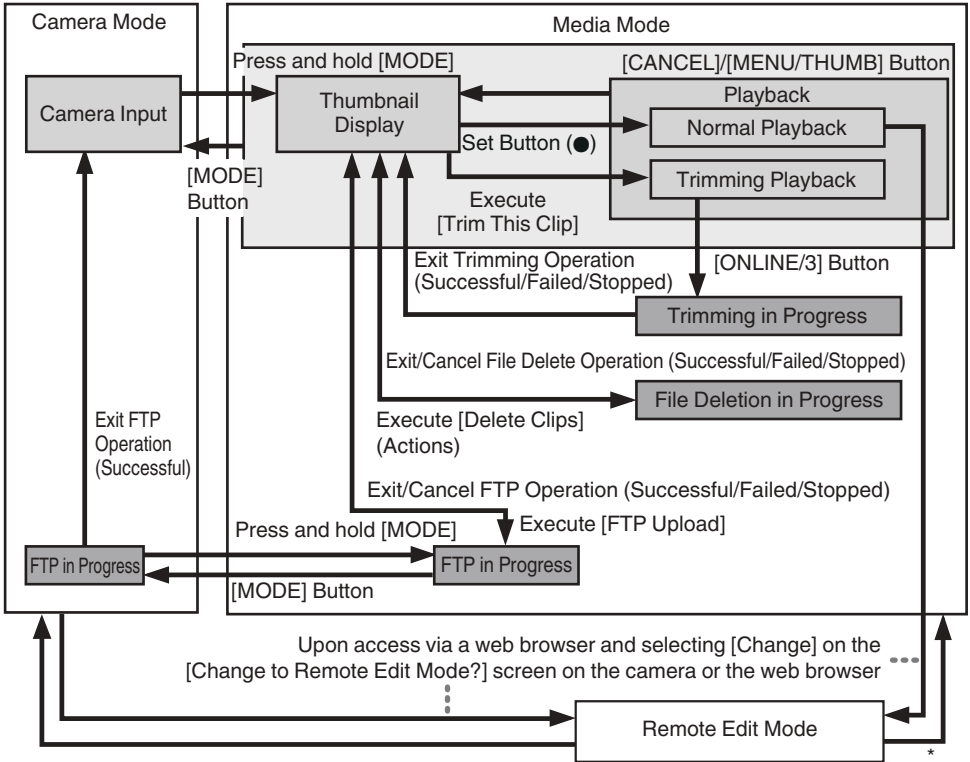

\* Selecting a mode other than the Metadata Edit mode via the web browser, or selecting [Exit] on the [Remote Edit Mode] screen

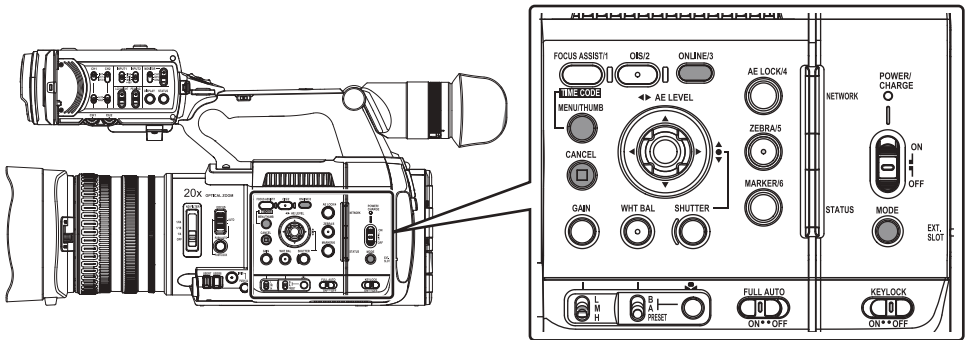



Operation Mode	Description
Camera Mode	<ul style="list-style-type: none"> <li>• This is the camera shooting mode. The camera recorder starts up in Camera mode when the power is turned on.</li> <li>• Camera images are output to the viewfinder and LCD monitor. When a recordable media is inserted, the camera recorder enters the recording standby mode. “STBY” appears on the operation mode display area of the LCD monitor and viewfinder.</li> <li>• Press the [REC] trigger button to start recording.</li> </ul> <p>Memo : _____</p> <ul style="list-style-type: none"> <li>• Playback of recording media is not possible in the Camera mode. However, you can check the most recently recorded video clip. (☞ P86 [Viewing Recorded Videos Immediately (Clip Review)] )</li> </ul>
Media Mode	<ul style="list-style-type: none"> <li>• This mode allows you to play back or delete clips recorded on the recording media.</li> <li>• When a playable recording media is inserted, the thumbnail or playback screen is displayed on the viewfinder and LCD monitor.</li> <li>• Press and hold the [MODE] selection button to enter the Media mode when you are not shooting in the Camera mode. Once the camera recorder is in Media mode, thumbnails of the selected media slot are displayed.</li> </ul>
Remote Edit Mode	<ul style="list-style-type: none"> <li>• This mode enables the list display and editing of the recorded clip data through access to the clip list display page via a web browser on a smartphone, tablet terminal, or PC.</li> <li>• When you access via a web browser on a smartphone, tablet terminal, or PC, “It is necessary to change the camera mode to “Remote Edit Mode”. Change the mode.” appears on the web browser. Also, “Change to Remote Edit Mode?” is displayed on the display screen of the camera unit. Selecting [Change] on the camera recorder and pressing the Set button switches to the Remote Edit mode, and enables display of the clip list and editing of the clip metadata. (☞ P188 [ Clip Metadata ] ) (☞ P190 [Uploading a Recording Clip via a Web Browser] )</li> </ul> <p>Memo : _____</p> <ul style="list-style-type: none"> <li>• If you access via a web browser on devices such as a smartphone, tablet terminal, or PC while recording is in progress, the message appears after recording stops.</li> <li>• If playback is in progress, the message appears once the files are closed automatically, such as when playback stops.</li> </ul>

# Names of Parts

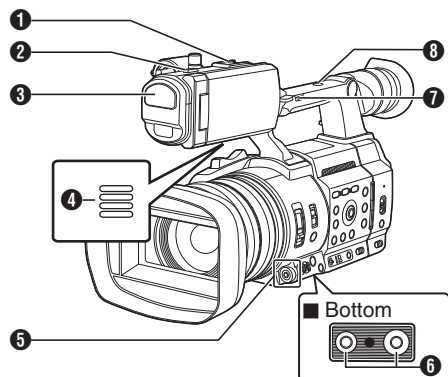

- 1** Shoe  
For mounting separately sold lights and accessories.
- 2** Tally Lamp  
(☞ P47 [Tally Lamp and LED] )  
(☞ P236 [Blinking of the Tally Lamp] )
- 3** Built-in Microphone  
(☞ P74 [Audio Recording] )
- 4** Monitor Speaker  
(☞ P100 [Audio Output during Playback] )
- 5** Cross-Shaped Button (▲▼◀▶)/Set Button (●)
  - For operating the menu and cursor and for confirming a setting, as well as for configuring the settings for time code and user's bit.
  - When a function is assigned to the cross-shaped button, it functions as a user button. (☞ P46 [Assignment of Functions to User Buttons] )
- 6** Tripod Mounting Screw Hole  
(☞ P33 [Attaching the Tripod (Sold Separately)] )
- 7** [FIX/VAR/OFF] zoom speed switch  
(☞ P59 [Zoom Operation] )  
For switching the zoom speed of the zoom lever **24** at the handle.
- 8** Accessory Mounting Screw Hole

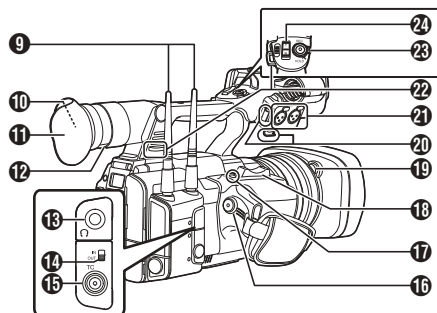

- 9** Wireless LAN Antenna Terminal **550**  
(☞ P34 [Attaching the Wireless LAN Antennas (Supplied) **550**] )
  - 10** Viewfinder  
(☞ P43 [Adjusting the LCD Monitor and Viewfinder] )
  - 11** Eyecup  
Prevents external light from entering the viewfinder screen and cameraman's vision.
  - 12** Visibility Adjustment Lever  
(☞ P43 [Adjusting the LCD Monitor and Viewfinder] )
  - 13** [ ] Headphone Jack (Φ3.5 mm)  
(☞ P76 [Monitoring Audio Sound During Recording Using a Headphone] )
  - 14** [TC IN/OUT] switch  
(☞ P81 [Synchronizing Time Code on Another Camera] )
  - 15** [TC] TC Input/Output Terminal  
(☞ P76 [Time Code and User's Bit] )
  - 16** [REC] Record Trigger Button  
Starts/stops recording.
- Memo : \_\_\_\_\_
- This switch is interlocked with the [REC/HOLD] button **23** at the top of the handle.
- 
- 17** [EXP.FOCUS/9] Expanded Focus Assist/User 9 Button
    - For switching the expanded focus ON or OFF.  
(☞ P62 [Expanded Focus Function] )
    - You can also use it as a user button by assigning a specific feature in the menu setting to this button.
  - 18** Zoom Lever at the Grip  
(☞ P59 [Using the Zoom Lever at the Grip] )

- 19 Hood Release Button  
(☞ P34 [Attaching/Detaching the Hood] )
- 20 External Microphone Cable Clamp  
(☞ P33 [Attaching the External Microphone  
(Sold Separately)] )
- 21 [INPUT1/INPUT2] Audio Input Terminal 1, 2  
(XLR 3-pin x 2)  
(☞ P33 [Attaching the External Microphone  
(Sold Separately)] )
- 22 Shoulder Belt Mount (x2)  
For mounting a shoulder belt (sold separately).

Caution : \_\_\_\_\_

- Be sure to use a shoulder belt with the strength to withstand the weight of this camera recorder.
- If the shoulder belt is not properly attached, the camera recorder may fall and cause injuries.
- Check the [INSTRUCTIONS] provided with the shoulder belt before using.

- 
- 23 [REC/HOLD] Record Trigger Button/Lock Switch  
Starts/stops recording.  
Set the switch to [HOLD] to lock the [REC] Trigger button.

Memo : \_\_\_\_\_

- This switch is interlocked with the [REC] button 16 on the grip.
  - [REC] button 16 on the grip is not locked.
- 
- 24 Zoom Lever on Handle  
(☞ P59 [Using the Zoom Lever at the Handle] )

## Side Control Panel

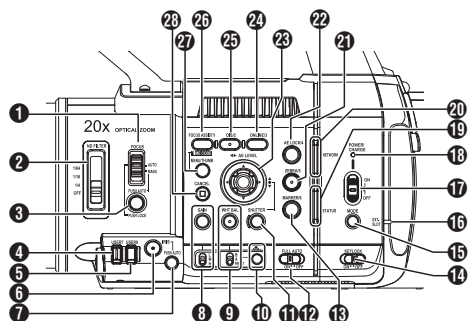

- 1 [FOCUS AUTO/MANU] Focus Switch  
(☞ P60 [Focus Operation] )
- 2 [ND FILTER] ND Filter Switch  
Use the ND filter to keep the lens aperture in the appropriate range.  
OFF, 1/4, 1/16, 1/64  
(☞ P68 [Setting the ND Filter] )
- 3 [PUSH AUTO/PUSH LOCK] Focus Push Auto/ Push Lock Button  
(☞ P60 [One Push Auto Focus] )  
(☞ P60 [Setting to Auto Focus Temporarily (Push Auto Focus)] )  
(☞ P60 [Locking the Focus] )
- 4 [USER7] Button  
It can be assigned with a specific menu function.  
(☞ P46 [Assignment of Functions to User Buttons] )
- 5 [USER8] Button  
It can be assigned with a specific menu function.  
(☞ P46 [Assignment of Functions to User Buttons] )
- 6 [IRIS] Iris Auto/Manual Selection Button  
(☞ P65 [Adjusting the Iris] )
- 7 [PUSH AUTO] Iris Push Auto Button  
(☞ P65 [Adjusting the Iris] )
- 8 [GAIN] Gain Auto/Manual Selection Button / [L/M/H] Sensitivity Selection Switch  
(☞ P66 [Setting the Gain] )
- 9 [WHT BAL] White Balance Auto/Manual Selection Button / [B/A/PRESET] Selection Switch  
(☞ P69 [Adjusting the White Balance] )
- 10 [One Push Auto White Balance Button]
- 11 [SHUTTER] Shutter Speed Auto/Manual Selection Button  
(☞ P67 [Setting the Electronic Shutter] )
- 12 [FULL AUTO ON/OFF] Full Auto Switch  
(☞ P64 [Adjusting the Brightness] )  
(☞ P69 [Automatic White Balance Mode (FAW: Fulltime Auto White balance)] )
- 13 [MARKER/6] Marker/User 6 Button  
This button toggles ON/OFF the marker, safety zone, and center mark displays.  
You can also use it as a user button by assigning a specific feature in the menu setting to this button.  
(☞ P46 [Assignment of Functions to User Buttons] )
- 14 [KEYLOCK ON/OFF] Key Lock Switch  
(☞ P54 [About the Operation Lock Feature (KEYLOCK)] )
- 15 [MODE] Camera/Media Mode Selection Button  
(☞ P24 [Operation Modes] )
- 16 EXT.SLOT Lamp  
Lights up in green when a media is inserted into EXT.SLOT, and lights up in red when the media is being accessed.
- 17 [POWER ON/OFF] Lock Power ON/OFF Switch  
Turns ON/OFF the power.
  - Hold down the lock button (blue) in the center to toggle ON/OFF.
  - When the power is turning OFF, “P.OFF” appears on the LCD monitor and viewfinder.
  - Wait for 5 seconds or more to turn on the power again.  
(☞ P38 [Turning On/Off the Power] )
- 18 POWER/CHARGE LED  
(☞ P35 [Using a Battery Pack] )
- 19 STATUS LED  
(☞ P148 [ STATUS LED ] )
- 20 NETWORK LED  
(☞ P148 [ NETWORK LED ] )

- 21** [ZEBRA/5] Zebra/User 5 Button  
(☞ P82 [Setting Zebra Pattern] )  
You can also use it as a user button by assigning a specific feature in the menu setting to this button.  
(☞ P46 [Assignment of Functions to User Buttons] )
- 22** [AE LOCK/4] AE Lock/User 4 Button  
When Gain, Iris, and Shutter are set to “AUTO”, their respective values and the value of white balance are locked when the [AE LOCK/4] button is pressed.  
You can also use it as a user button by assigning a specific feature in the menu setting to this button.  
(☞ P46 [Assignment of Functions to User Buttons] )
- 23** Cross-Shaped Button (▲▼◀▶)/Set Button (●)  
The function changes according to the operation status of the camera recorder.  
■ During menu operation (all modes)  
(☞ P107 [Basic Operations in Menu Screen] )  
Set Button (●) : Confirms menu items and setting values  
Cross-shaped Button : Selects menu items and setting values  
(▲▼)  
■ During Camera mode  
Shutter operation:  
Set Button (●) : Shutter ON/OFF  
Cross-shaped Button : Switches shutter speed when shutter is ON  
(▲▼)  
Cross-Shaped Button : AE level operation  
(◀▶)
- 24** [ONLINE/3] Online/User 3 Button  
• Switches live streaming between ON/OFF.  
(☞ P208 [Starting Distribution] )  
• You can also use it as a user button by assigning a specific feature in the menu setting to this button. Initial setting: Live streaming  
(☞ P46 [Assignment of Functions to User Buttons] )
- 25** [OIS/2] Optical Image Stabilizer/User 2 Button  
For switching the image stabilizer feature mode ON or OFF.  
You can also use it as a user button by assigning a specific feature in the menu setting to this button.  
(☞ P46 [Assignment of Functions to User Buttons] )
- 26** [FOCUS ASSIST/1] Focus Assist/User 1 Button  
For switching the focus assist function ON or OFF.  
(☞ P61 [Focus Assist Function] )  
You can also use it as a user button by assigning a specific feature in the menu setting to this button.  
(☞ P46 [Assignment of Functions to User Buttons] )
- 27** [MENU/THUMB] Menu/Thumbnail Button  
• Displays the menu screen during Camera mode.  
• Switches between [Main Menu] and [Favorites Menu] when the [MENU/THUMB] button is pressed and held down while the menu screen is displayed.  
(☞ P107 [Basic Operations in Menu Screen] )  
• Displays the menu screen when the button is pressed during thumbnail display in the Media mode.  
• Stops playback and displays the thumbnail screen when the button is pressed during playback screen display in the Media mode.
- 28** [CANCEL] Cancel Button  
Cancels various settings and stops playback.

## Rear Terminal

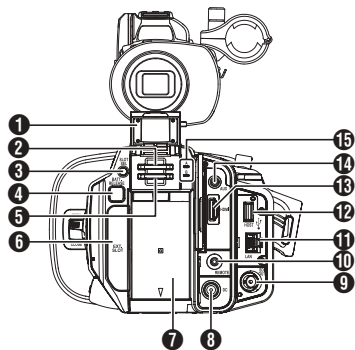

- ❶ SD Card Cover
- ❷ Card Slot A
- ❸ [SLOT SEL] Button  
For switching the active card slot during shooting and playback.
- ❹ [BATT.RELEASE] Button  
(☞ P35 [Removing the Battery] )

- ❺ Card Slot B
- ❻ [EXT.SLOT]  
SSD media adapters (sold separately) such as KA-MC100 can be inserted into the slot.  
(☞ P51 [Inserting the SSD Media Adapter] )
- ❼ Battery  
(☞ P35 [Using a Battery Pack] )
- ❽ [DC] Terminal  
Input terminal for DC 12 V power supply. For connecting with the supplied AC adapter.  
(☞ P36 [Using AC Power (DC IN Power)] )
- ❾ [SDI OUT] Terminal  
(☞ P175 [Connecting External Monitor] )
- ❿ [REMOTE] Terminal  
(☞ P176 [Connecting Wired Remote Control] )
- ⓫ [LAN] Terminal  
For connecting the LAN cable.
- ⓬ [HOST] USB Host Terminal  
For connecting a USB adapter according to the intended purpose when you are connecting the unit to a network.  
(☞ P178 [Camera Setup for Network Connection] )
- ⓭ [HDMI] Terminal  
(☞ P175 [Connecting External Monitor] )
- ⓮ [AUX] Terminal (Φ3.5 mm)  
For connecting to receiver such as wireless microphone.
- ⓯ Access Lamp A/B

## LCD Monitor

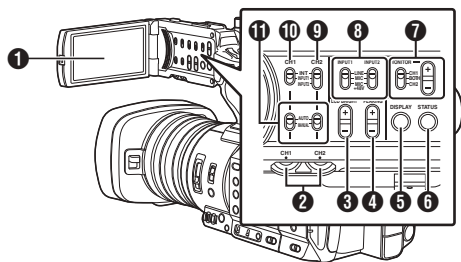

- 1 LCD Monitor  
(☞ P43 [Adjusting the LCD Monitor and Viewfinder])
- 2 [CH1/CH2] CH1/CH2 Recording Level Adjustment Knob  
(☞ P74 [Audio Recording])
- 3 [LCD BRIGHT +/-] LCD Display Brightness Adjustment Button  
(☞ P44 [Adjusting the Brightness])
- 4 [PEAKING +/-] LCD/VF Contour Adjustment Button  
(☞ P44 [Adjusting the Contour (LCD)])  
(☞ P45 [Adjusting the Contour (Viewfinder)])
- 5 [DISPLAY] Display Button
  - Press the [DISPLAY] button to switch to the display screen during normal screen display (when the menu screen is not displayed).  
(☞ P41 [Display Screen])
  - Switches between [Main Menu] and [Favorites Menu] when the [DISPLAY] button is pressed while the menu screen is displayed.  
(☞ P107 [Basic Operations in Menu Screen])
- 6 [STATUS] Status Screen Display Button  
Press the [STATUS] button to display the status screen on the viewfinder and LCD monitor during normal screen display (when the menu screen is not displayed).  
(☞ P42 [Status Screen])
- 7 [MONITOR]/[+/-] Audio Monitor Selection Switch/Volume Adjustment Button  
Switches the audio monitor and adjusts the monitor speaker/headphone.  
(☞ P76 [Monitoring Audio Sound During Recording Using a Headphone])

- 8 [INPUT1/INPUT2] Audio Input Signal Selection Switch  
(☞ P74 [Audio Recording])
- 9 [CH2] CH2 Audio Input Signal Selection Switch  
Select the audio input terminal to record to CH2.  
(☞ P74 [Audio Recording])
- 10 [CH1] CH1 Audio Input Signal Selection Switch  
(☞ P74 [Audio Recording])
- 11 [CH1/CH2 AUTO/MANUAL] CH1/CH2 Audio Recording Mode Switch  
(☞ P75 [Adjusting Audio Recording Level])

## Lens Section

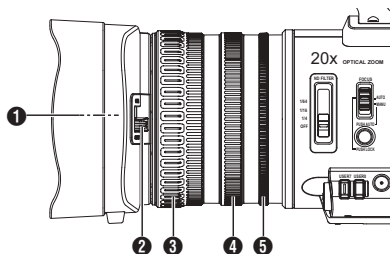

- 1 Filter Built-In Screw
  - Transparent or UV filter for lens protection, or filters for various effects can be installed.
  - Installable filter types:  $\Phi 82$  mm

Memo : \_\_\_\_\_

- Remove the lens hood when installing the filter.  
(☞ P34 [Attaching/Detaching the Hood])
- 
- 2 Lens Cover Open/Close Switch  
(☞ P33 [Opening/Closing the Lens Cover])
  - 3 Focus Ring  
(☞ P60 [Focus Operation])
  - 4 Zoom Ring  
(☞ P59 [Zoom Operation])
  - 5 Iris Ring  
(☞ P65 [Adjusting the Iris])  
To operate auto iris, press the [IRIS] button on the side control panel.  
(**A** mark appears on the screen)

# Basic System Diagram

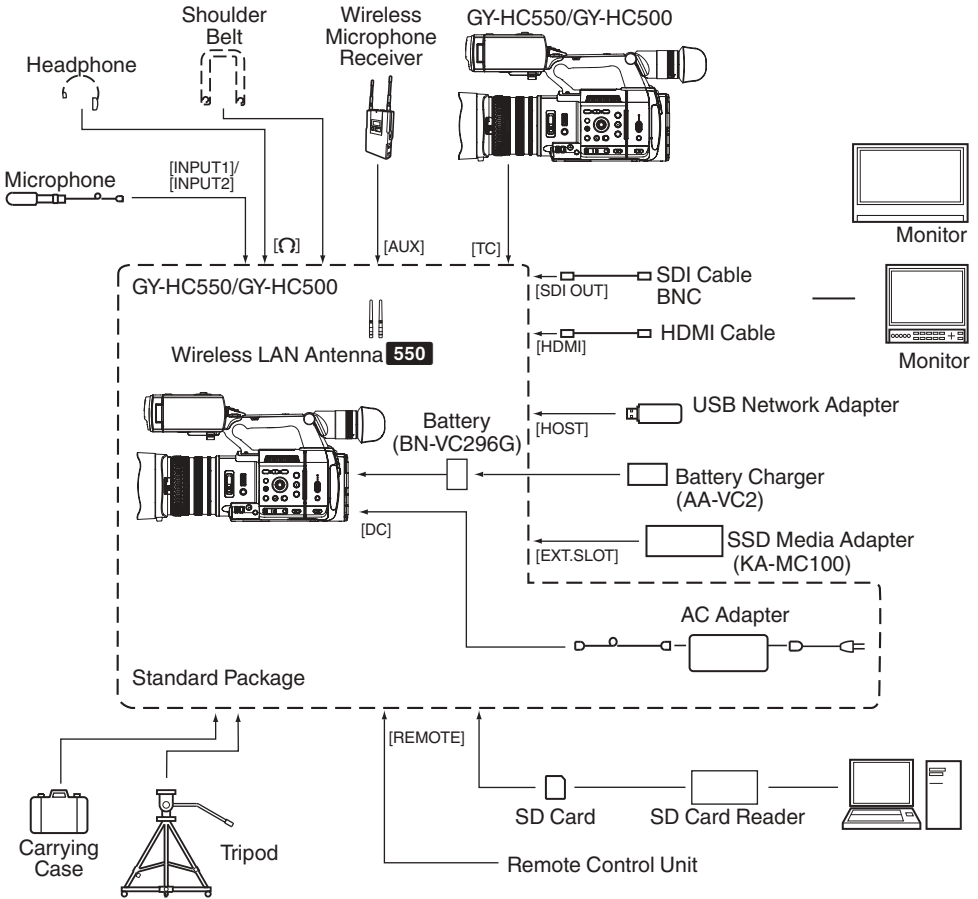



# Settings and Adjustments Before Use

## Adjusting the Grip Belt

Open the pad and adjust the position of the grip belt accordingly.

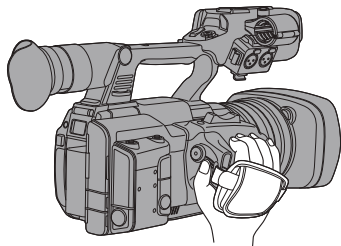

Caution : \_\_\_\_\_

- If the grip is loose, the camera recorder may fall off resulting in injuries or malfunction.

## Attaching the External Microphone (Sold Separately)

You can attach a separately sold microphone to the microphone holder.

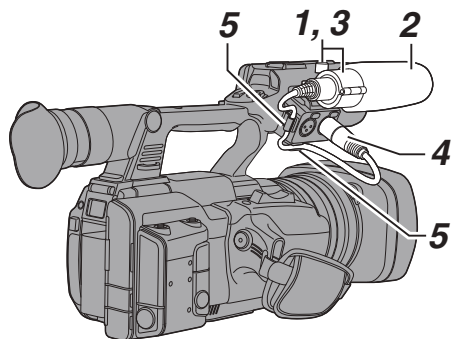

- 1 Turn the knob on the microphone holder counterclockwise to loosen and open the microphone holder.
- 2 Place the microphone in the microphone holder.
- 3 Turn the knob on the microphone holder clockwise to secure the microphone.
- 4 Connect the microphone cable to the [INPUT1] or [INPUT2] terminal.
- 5 Pin the microphone cable to the clamp.
- 6 Perform the settings for the microphone correctly.  
(P74 [Audio Recording])

## Opening/Closing the Lens Cover

Use the lens cover open/close switch to open or close the lens cover.  
Before shooting, open the lens cover.  
When this camera recorder is not in use, close the lens cover to protect the lens.

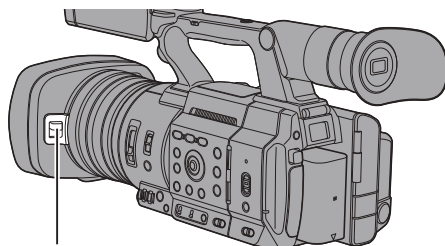

Lens cover switch

Caution : \_\_\_\_\_

- Do not press against the lens cover with force. Doing so may damage the lens or the cover.

## Attaching the Tripod (Sold Separately)

Use the screw hole at the bottom of this camera recorder.

(3/8×16UNC, 1/4×20UNC)

Use the screw hole that suits the tripod.

To prevent the camera recorder from falling off, which may result in injuries or damages, read the "INSTRUCTIONS" of the tripod to be used and make sure that it is securely attached.

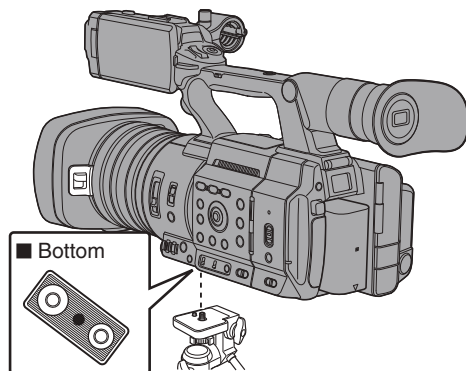

Caution : \_\_\_\_\_

- If the camera recorder exceeds the weight limit of the tripod, do not mount it on the tripod.
- Use the tripod on a stable surface.
- To prevent the camera recorder from falling, attach securely using the rotation prevention hole.
- Use screws with screw length 5 mm and below.

## Attaching the Wireless LAN Antennas (Supplied) 550

Attach the wireless LAN antenna by turning it in the clockwise direction. Hold the base while attaching the antenna.

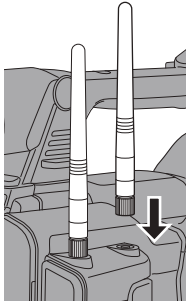

Caution : \_\_\_\_\_

- Applying force to the wireless LAN antenna or yanking it may damage the antenna so please use caution when using the antenna. If it is damaged, replacement is chargeable even during the warranty period. (Part number: T9A-0095-00)
- Use the antenna holders without removing them.

## Attaching/Detaching the Hood

### Attaching the Hood

Align the markings on the camera recorder and hood; turn the hood in the direction of the arrow until it is locked.

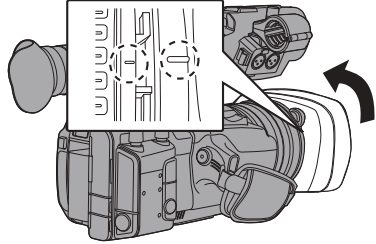

### Detaching the Hood

While pressing the hood release button, turn the hood in the direction of the arrow (anti-clockwise) to remove it.

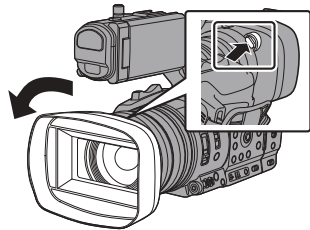

Caution : \_\_\_\_\_

- Remove the hood when attaching a filter, teleconverter or wide converter to the front of the lens.

# Power Supply

To use this camera recorder, you can attach a battery pack or connect an AC adapter to it.

(☞ P35 [Using a Battery Pack])

(☞ P36 [Using AC Power (DC IN Power)])

Caution :

- Set the [POWER ON/OFF] switch to "OFF" before changing the power supply that operates this camera recorder.
- To charge the battery using a battery charger, purchase a genuine charger that can charge the recommended battery.

## Using a Battery Pack

### Charging the Battery

Charge the battery immediately after purchase or when the battery power is running low.

\* The battery is not charged when purchased.

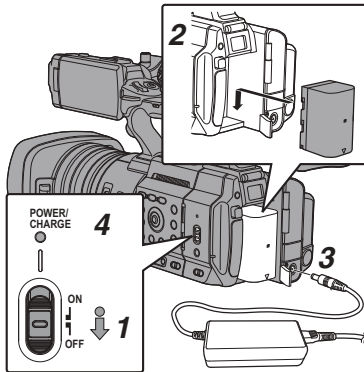

- 1 Hold down the lock button (blue) at the center of the [POWER ON/OFF] switch to set to "OFF".
- 2 Attach the supplied battery. Slide it in until you hear a click.
- 3 Connect the supplied AC adapter to the [DC] terminal. Open the cover of the [DC] terminal and connect as shown in the diagram.
- 4 Connect the AC adapter to a power outlet.
  - The [POWER/CHARGE] lamp blinks during charging and will go out after charging is complete.
  - Remove the AC adapter after charging is complete.

Memo :

- Blinking of the [POWER/CHARGE] lamp during charging indicates the charge level.

[POWER/CHARGE] Lamp during "POWER.OFF"	Charge Level
Alternates between a blinking orange light (4 times) and light off (1 second)	Less than 25 %
Alternates between a blinking orange light (3 times) and light off (1 second)	Less than 50 %
Alternates between a blinking orange light (2 times) and light off (1 second)	Less than 75 %
Alternates between a blinking orange light (blinks once) and light off (1 second)	Less than 100 %
Light goes out	Fully charged

- You can charge the battery even when operating the camera recorder using the AC adapter. The lamp lights up in green during "POWER.ON".

### Removing the Battery

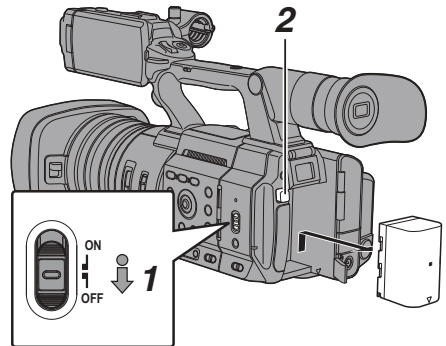

- 1 Hold down the lock button (blue) at the center of the [POWER ON/OFF] switch to set to "OFF".
- 2 While pressing and holding the [BATT. RELEASE] button, push up and remove the battery in the direction of the arrow.

Caution :

- Do not remove the battery when the [POWER ON/OFF] switch is "ON".
- Leaving the camera recorder unused with the battery attached will deplete the battery power even when you set the [POWER ON/OFF] switch to "OFF". Remove the battery if you are not using the camera recorder.

## Estimated Charging and Continuous Operating Times

■ Charging time  
 BN-VC296G (accessory): Approx. 5 hours

\* When the [POWER ON/OFF] switch is set to "OFF"

Memo : \_\_\_\_\_

- If you charge the battery immediately after using while the battery is still warm, it may not be fully charged.
- It is recommended that you charge the battery in an environment between 10 °C and 30 °C (50 °F and 86 °F). The battery may not be fully charged or the charging time may be prolonged if charged under low temperatures (below 10 °C/ 50 °F). In addition, charging the battery under high temperature (above 30 °C/86 °F) condition may shorten the battery life.

■ Continuous operating time  
 BN-VC296G (accessory): Approx. 2 hrs 40 mins (\*1)  
 Approx. 2 hrs 50 mins (\*2)

- \*1 When [System] is set to "4K" and all other settings are in factory default  
 \*2 When [System] is set to "HD" and all other settings are in factory default

Memo : \_\_\_\_\_

- Actual operating times may differ depending on the age of the battery, charging condition, and operating environment.
- Operating time is shortened in cold environment.
- The operating time may shorten when power zoom is used, accessories are connected, or when the LCD monitor is frequently used.
- For purchase of spare batteries and battery charger, please contact the local dealers in your area.

## Precautions for Batteries

- Store the battery in a cool and dry place when not in use. Do not expose the battery to high temperatures (such as in a car under direct sunlight). Failure to do so not only shortens the battery life but also damages the battery.
- If the operating time shortens drastically even after charging, the battery may be reaching the end of its life. Replace the battery with a new one.

## Using AC Power (DC IN Power)

Use the supplied AC adapter to operate the camera recorder with AC power.

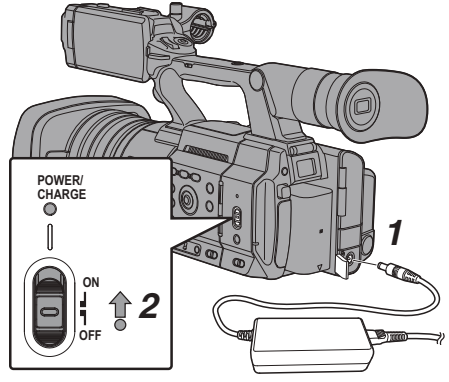

- 1 Connect the DC cable of the AC adapter to the [DC] terminal of the camera recorder.**
  - Check that the power switch of the camera recorder is set to "OFF".
  - Open the cover of the [DC] terminal and connect as shown in the diagram.
- 2 Hold down the lock button (blue) at the center of the [POWER ON/OFF] switch to set to "ON".**  
 Power will be supplied to the camera recorder.

Caution : \_\_\_\_\_

- Do not insert or remove the DC cable during recording.
- Do not use power supply of high voltage fluctuation, containing noise such as ripple, or with insufficient capacity.

## Charging the Built-In Battery

- The date/time and time code data are stored using the built-in rechargeable battery.
- When power is connected to the camera recorder, the built-in battery always gets charged. When the power is disconnected, the battery gradually discharges.
- The battery will be totally discharged if left unused for 3 months and the date/time and time code data will be reset. When this happens, set the [POWER ON/OFF] switch to "ON" to display the [Initial Setting] screen, then set the date/ time.  
 (P39 [Initial Settings])

# Power Status Display

## Viewfinder Screen and LCD Monitor

The power status is displayed on the display and menu screens.

Display	Description
	<p>Currently powered by a battery. When the battery power runs out, the battery mark appears hollow, and “RES” (yellow) is displayed.</p> <p>Memo : _____</p> <ul style="list-style-type: none"> <li>You can set the display using [LCD/VF] → [Display Type] → [Battery]. (☞ P128 [ Battery ] )</li> </ul>
	Acquisition of battery information may fail if a genuine battery is not used.
	Appears when an error occurs during battery charging.
	Currently powered by an AC adapter.
	<p>Camera recorder battery charging in progress. (☞ P128 [Details on charging condition] ) (☞ P128 [ Battery ] )</p>

Memo : \_\_\_\_\_

- If the supplied battery (or equivalent battery sold separately) is not used, the battery mark which indicates the battery level may not appear.

## Display Screen

(☞ P159 [Display Screen in Camera Mode] )  
(☞ P165 [Display Screen in Media Mode] )

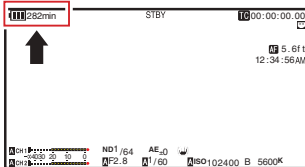

## Menu Screen

(☞ P108 [Display and Description of the Menu Screen] )

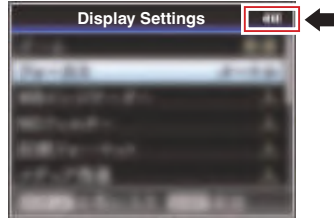

## Warnings by Lamp and Warning Tone

Warning status is indicated by tally lamp and warning tone.

- The tally lamp blinks.
- The warning tone is output from the monitor speaker or [Ⓛ] terminal.

Memo : \_\_\_\_\_

- You can specify whether to turn on the warning tone as well as setting the volume in [A/V Set] → [Audio Set] → [Alarm Level].  
(☞ P134 [ Alarm Level ] )
- In the event that the battery level runs low while it is being used, the camera recorder will stop operating automatically.

Caution : \_\_\_\_\_

- The remaining battery power and time are displayed as they are from the battery information. Accurate data may not be displayed depending on the battery condition. Replace the battery as soon as possible when the remaining battery power and time are low.

# Turning On/Off the Power

## Turning On the Power

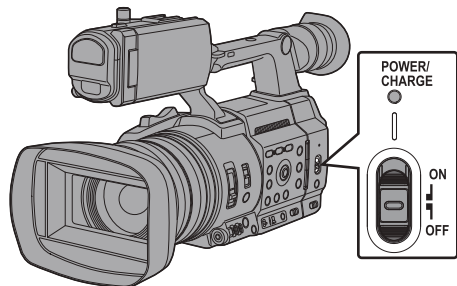

- 1 Hold down the lock button (blue) at the center of the [POWER ON/OFF] switch to set to "ON".

The camera recorder starts up in Camera mode and is ready for shooting.

Memo : \_\_\_\_\_

- The camera recorder always start up in Camera mode when the [POWER ON/OFF] switch is set to "ON". Use the [MODE] button at the side of the camera recorder to switch mode.  
(☞ P24 [Operation Modes] )
- The camera recorder behaves as follows when an AC adapter is connected.
  - If the battery is not fully charged, the battery will be charged at the same time.
  - Even when a fully charged battery is used, charge the battery briefly to confirm the remaining battery power.  
(☞ P35 [Power Supply] )  
(☞ P37 [Power Status Display] )

## Turning Off the Power

Sets the camera recorder to the recording standby or stop mode.

- 1 Hold down the lock button (blue) at the center of the [POWER ON/OFF] switch to set to "OFF".
- 2 Remove the battery and the power to the [DC] terminal (when not in use for a long time).

Caution : \_\_\_\_\_

- Do not set the [POWER ON/OFF] switch to "OFF" during recording. Check that the operation mode display is "STBY" or "STOP" before you turn off the power.
- If you have mistakenly set the [POWER ON/OFF] switch to "OFF" during recording, wait for 5 seconds or more before you turn on the power again.
- When turning off the power, first set the [POWER ON/OFF] switch of the camera recorder to "OFF". Do not remove the battery or turn off the AC power while the [POWER ON/OFF] switch is set to "ON".

# Initial Settings

When the power is first turned on, the Initial Setting screen for performing the initial settings in the camera recorder appears.

Set the date/time of the built-in clock in the [Date/Time] screen.

All operations are disabled until initial settings are complete.

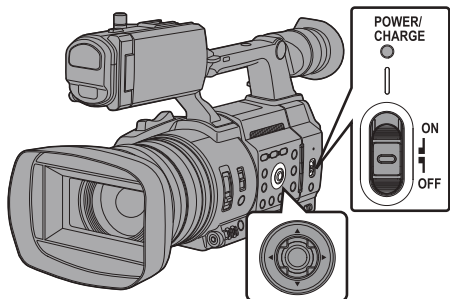

Memo : \_\_\_\_\_

- It is recommended to use the AC adapter as the power supply.
- Be sure to close the lens cover.

## 1 Hold down the lock button (blue) at the center of the [POWER ON/OFF] switch to set to "ON".

A language selection screen appears.

- For U models



- For E models



Memo : \_\_\_\_\_

- The menus and messages on the screen of the LCD monitor or viewfinder are displayed in the selected language.

## 2 Select a language using the cross-shaped button (▲▼), and press the Set button (●).

A self-diagnosis screen appears.



## 3 Ensure that the lens cover is closed, and press the Set button (●).

- Self-diagnosis starts.
- A progress bar appears, and "Complete Diagnosis" appears when the diagnosis is complete.

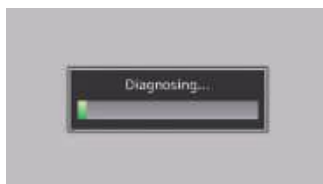

Memo : \_\_\_\_\_

- It takes about 6 minutes to complete the diagnosis. During the diagnosis, do not operate or turn off the camera recorder.

#### 4 Press the Set button (●) after confirming the exit screen.

The [Date/Time] screen appears.

- For U models



- For E models



#### 5 Set the time zone and date/time.

- ① Move the cursor with the cross-shaped button (◀▶) and select the setting item.
- ② Change the values with the cross-shaped button (▲▼).

#### 6 Press the Set button (●) after setting is complete.

The clock is set to 0 seconds of the input date/time.

Memo : \_\_\_\_\_

- The configured date/time data can be displayed on the LCD monitor and viewfinder screen and be recorded to a recording media.
- The value of the year can be set in the range of “2000” to “2099”.
- The configured date/time data is saved in the built-in battery even if the power is turned off.

## Changing the Time after Initial Setting

### Setting the Date/Time

(☞ P148 [ Date/Time ] )

#### 1 Select [System] → [Date/Time].

The [Date/Time] screen appears.

#### 2 Set the date and time.

- ① Move the cursor with the cross-shaped button (◀▶) and select the setting item.
- ② Change the values with the cross-shaped button (▲▼).

#### 3 Press the Set button (●) after setting is complete.

The clock is set to 0 seconds of the input date/time.

## Changing the Display Style

You can change the display style of the date/time on the menu.

### Setting the Date Display (Date Style)

(☞ P148 [ Date Style ] )

The date display can be changed in [System] → [Date Style].

### Setting the Time Display (Time Style)

(☞ P149 [ Time Style ] )

The time display can be changed in [System] → [Time Style].

## Date/Time Display in Each Operation Mode

During Camera mode:

Time of the built-in clock is displayed.

During Media mode:

Shooting date/time of the clip being played back is displayed.



# Displays on the LCD Monitor and Viewfinder

You can display the camera status, recording media information, zebra pattern, and various markers in the video image on the LCD monitor and viewfinder screen during shooting.

Memo :

- When [A/V Set] → [Video Set] → [SDI OUT] → [Character] is set to "On", the display screen and menu screen are also displayed in the video image of the video signal output terminal.  
( P130 [ Character ] )

## Display Screen

### Display Screen (VF/LCD) in Camera Mode

- ( P159 [ Display Screen in Camera Mode ] )
- The display switches with every press of the [DISPLAY] button.  
( Display off → Display on → Display off )
- Press the [STATUS] button to switch to the status screen.  
( P167 [ Status Screen ] )

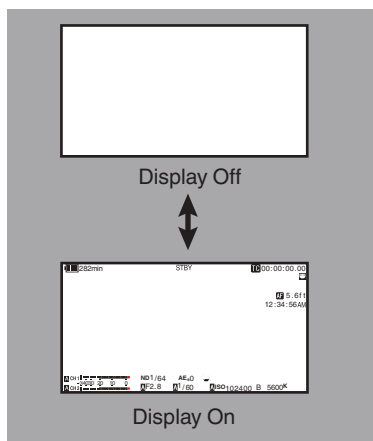

### Display Screen (VF/LCD) in Media Mode

- ( P165 [ Display Screen in Media Mode ] )
- This is the screen display during clip playback in Media Mode.
- The display switches with every press of the [DISPLAY] button.  
( Display off → Display on → Display off )

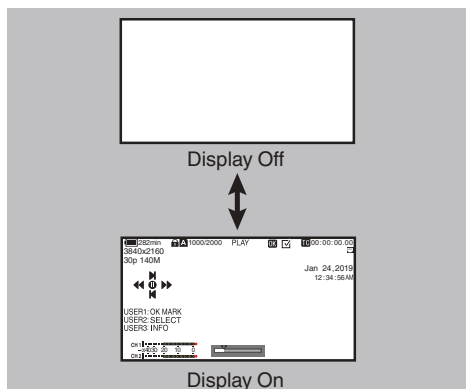

## Status Screen

- This screen allows you to check the current settings.
- To display the status screen, press the [STATUS] button in the normal screen.
- Press the [STATUS] button again to return to the normal screen.
- Press the [MENU/THUMB] button at each status screen (other than the [Camera] screen) to enter the setting screen.
- Use the cross-shaped button (◀▶) to switch between the screens.

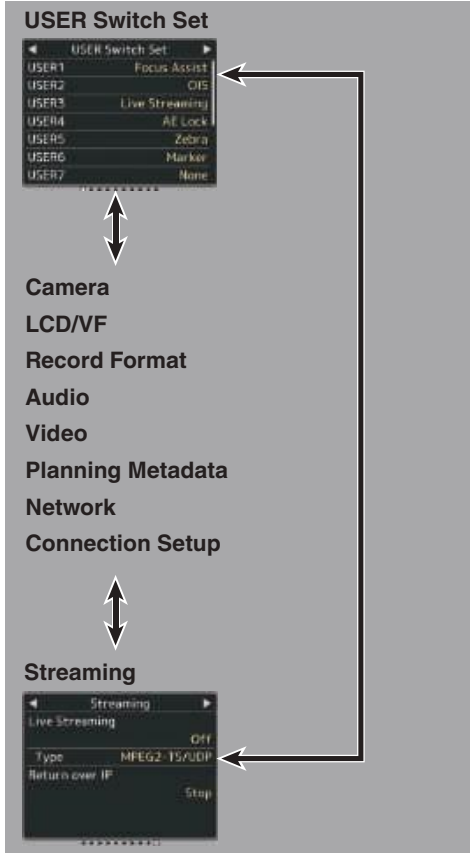

\* These are screen examples. The contents displayed are different depending on the model and settings.

## Remote Edit Mode Screen

This is a mode for accessing the page for editing the metadata that is recorded in a clip via a web browser on devices such as a smartphone, tablet terminal, or PC.  
 (☞ P188 [Clip Metadata])

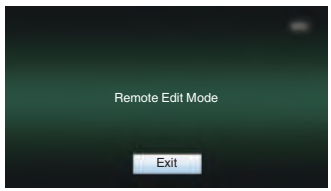

## Warning Display

Warning display is displayed in the display screen (Camera mode, Media mode).  
 (☞ P231 [Error Messages and Actions])

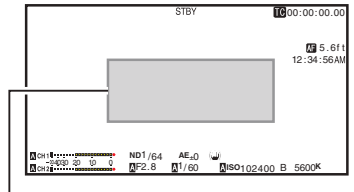

Warning Display Area

# Adjusting the LCD Monitor and Viewfinder

You can monitor video images on this camera recorder using the viewfinder, LCD monitor, or both.

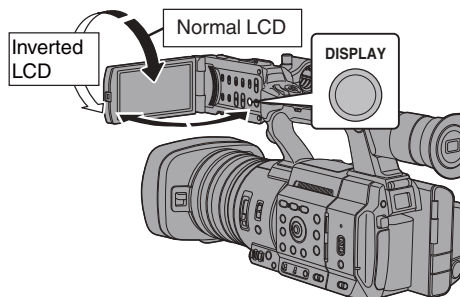

## Displays on the LCD Monitor and Viewfinder Screen (VF)

LCD Monitor Status		LCD Display	VF Display
LCD closed	Normal LCD	OFF	ON
	Inverted LCD	ON	OFF
LCD opened	Normal LCD	ON	OFF
	Inverted LCD	ON	OFF

Memo :

- Press and hold the [DISPLAY] button for 2 seconds to turn ON/OFF the LCD monitor.
- The function to switch between LCD monitor and viewfinder displays by pressing the [DISPLAY] button can be canceled by opening/closing or rotating the LCD monitor.

## Adjusting the LCD Monitor

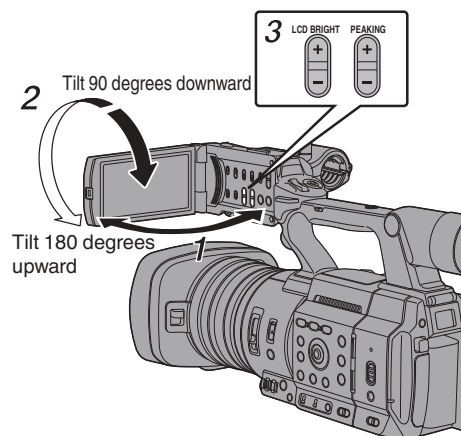

- 1 **Open the LCD cover.**
- 2 **Incline the LCD monitor to a position that enables easy viewing.**

Rotate the LCD monitor to adjust the angle.

- While the LCD monitor is open, you can rotate it 180 degrees upward or 90 degrees downward.
- Rotating the LCD monitor 180 degrees upward enables you to see the screen from the lens side. To display the image when it is viewed from the opposite direction (mirror image), perform setting as follows.  
Set [LCD/VF] → [LCD Mirror] to "Mirror" → Set button (●)

(P125 [ LCD Mirror ])

- 3 **Adjust the brightness, contour, and contrast of the LCD monitor.**

You can change the angle and brightness of the LCD monitor according to your usage condition. Changing the brightness of the screen will not affect the recorded images.

## Adjusting the Brightness

Use the [LCD BRIGHT +/-] button to adjust the brightness of the LCD monitor.

- The [+] button brightens the monitor and the [-] button darkens it.
- Press the [+] and [-] buttons simultaneously to return to standard settings.
- During adjustment, the brightness level is displayed on the LCD monitor.

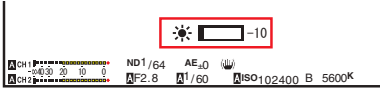

## Adjusting the Contour

Use the [PEAKING +/-] button to adjust the contour of the LCD monitor. (The contour of the viewfinder screen will also be adjusted.)

- The [+] button increases contour correction and the [-] button decreases contour correction.
- Press the [+] and [-] buttons simultaneously to return to standard settings.
- During adjustment, the contour level is displayed on the LCD monitor.

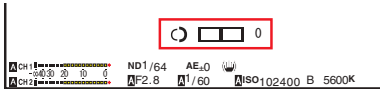

## Adjusting the Contrast

Use the [LCD Contrast] menu to adjust the contrast of the LCD monitor.

- Adjust using [LCD/VF] → [LCD Contrast]. (P125 [LCD Contrast])
- Increasing the value increases the contrast. [Setting Values: +10 to -10] (Default value: 0)

## Adjusting the Viewfinder

You can change the brightness and peaking of the viewfinder screen according to your usage conditions.

Changing the brightness of the screen will not affect the recorded images.

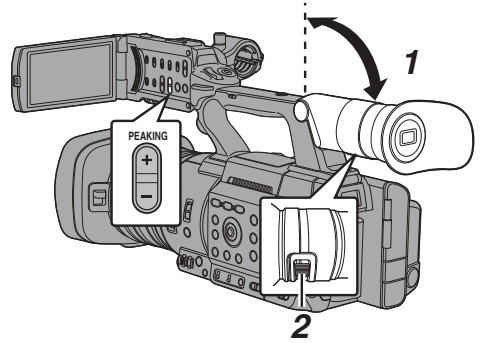

Caution : \_\_\_\_\_

- A high-definition viewfinder is used on this camera recorder in order to provide an accurate focusing environment. Due to the characteristic of the display device, colors may appear on the images when you blink your eyes. This is not a malfunction. It does not affect the recorded images, SDI output, or HDMI output.

- Incline the viewfinder vertically to a position that enables easy viewing.**
- Turn the visibility adjustment lever to adjust the visibility.**  
Turn the visibility adjustment lever to sharpen the image on the viewfinder screen.
- Adjust the brightness, contour, and contrast of the viewfinder screen.**

## Adjusting the Brightness

Use the [VF Bright] menu to adjust the brightness of the viewfinder screen.

- Adjust using [LCD/VF] → [VF Bright].  
(☞ P125 [ VF Bright ] )
- Increasing the value increases the brightness. [Setting Values: +10 to -10]  
(Default value: 0)

## Adjusting the Contour

Use the [PEAKING +/-] button to adjust the contour of the viewfinder screen. The contour of the LCD monitor will also be adjusted.

(☞ P44 [Adjusting the Contour] )

Memo : \_\_\_\_\_

- When [LCD/VF] → [LCD + VF] is set to "Off", operate after switching to the viewfinder display by pressing the [DISPLAY] button for 2 seconds or longer.

## Adjusting the Contrast

Use the [VF Contrast] menu to adjust the contrast of the viewfinder screen.

- Adjust using [LCD/VF] → [VF Contrast].  
(☞ P125 [ VF Contrast ] )
- Increasing the value increases the contrast.  
[Setting Values: +10 to -10] (Default value: 0)

## Displaying in Black and White

You can display the viewfinder screen in black and white.

- [LCD/VF] → [VF Color] item → Press Set button (●) → "Off" Select → Press Set button (●).

(☞ P125 [ VF Color ] )

# Assignment of Functions to User Buttons

You can assign functions to the following buttons and use them as user buttons. By assigning functions to the buttons, the usability of the camera recorder can be enhanced. Perform settings in the menu items corresponding to each button.

Button	Menu Item
[FOCUS ASSIST/1] Button	USER1
[OIS/2] Button	USER2
[ONLINE/3] Button	USER3
[AE LOCK/4] Button	USER4
[ZEBRA/5] Button	USER5
[MARKER/6] Button	USER6
[USER7] Button	USER7
[USER8] Button	USER8
[EXP.FOCUS/9] Button	USER9
Front Cross-Shaped Button ([▲])	USER10 ▲
Front Cross-Shaped Button ([▼])	USER11 ▼
Front Cross-Shaped Button ([◀])	USER12 ◀
Front Cross-Shaped Button ([▶])	USER13 ▶

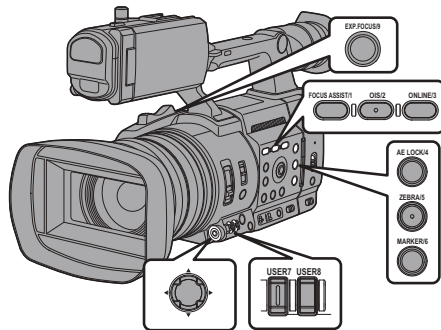

## 1 Assign functions to the buttons from the menu.

Configure each item to the user buttons in [Camera Function] → [User Switch Set].  
(☞ P116 [User Switch Set Item] )

Memo : \_\_\_\_\_

- Operations of the user buttons are interlocked with the menu settings.
- When the menu screen is displayed, these buttons function as the menu operation buttons.  
(☞ P107 [Basic Operations in Menu Screen] )

# Tally Lamp and LED

This is the indicator lamp for recording, warning and network.

The operation changes according to the menu settings.

\* Set using [System] → [Tally Lamp]/[NETWORK LED]/[STATUS LED].

(P147 [ Tally Lamp ])

(P148 [ NETWORK LED ])

(P148 [ STATUS LED ])

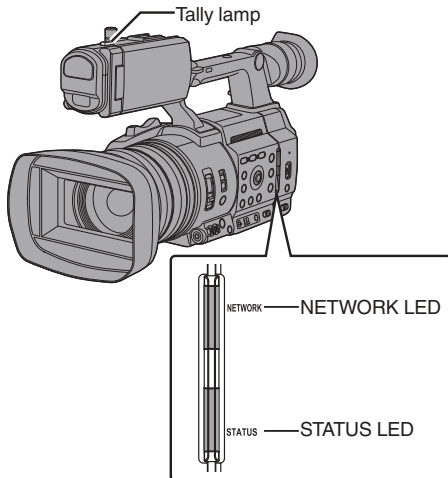

## • Tally Lamp Behavior

		[Tally Lamp] Setting				
		Rec/Live Streaming	Live Streaming	Rec	External	Off
Camera	Warning		▲			-
	Alarm		■			-
Recorder Status	Recording	●	-	●	-	-
	During live streaming		●	-	-	-
Input from Remote Control Unit	PROGRAM	-	-	-	●	-
	PREVIEW	-	-	-	●	-

## • NETWORK LED Behavior

	[NETWORK LED] Setting	
	On	Off
Activating	■ (Green)	-
Warning	▲ (Red)	-
During live streaming	● (Red)	-
Waiting for live streaming connection	● (Orange)	-
Error during live streaming	● (Orange)	-

## • STATUS LED Behavior

		[STATUS LED] Setting			
		REC/Pre Rec	External	Return over IP	Off
Activating		■ (Green)			-
Warning		▲ (Red)			-
On Pre Rec standby		● (Green)	-	-	-
Recording		● (Red)	-	-	-
Remaining space in media running low (Only during recording)		● (Orange)	-	-	-
Input from Remote Control Unit	PROGRAM	-	● (Red)	-	-
	PREVIEW	-	● (Green)	-	-
Return over IP in Progress		-	-	● (Green)	-
Error during Return over IP		-	-	● (Orange)	-

- : Lights up
- ▲ : Flashes rapidly
- : Blinks slowly

# Recording Media

This camera recorder saves recorded audio sound and videos except those in “4K EXT (SSD)” quality to the SD card (sold separately) in the card slot. Audio sound and videos in “4K EXT (SSD)” will be recorded to the SSD media (sold separately) in the KA-MC100 SSD Media Adapter (sold separately) that is inserted into the [EXT.SLOT].

## Usable Cards

### Format Setting and Usable SD Card Combinations

System	Format	Bit Rate	Usable SD Card
High-Speed	QuickTime (H.264)	4:2:2 10 70M (XHQ), 4:2:2 10 50M (XHQ), 50M (XHQ), 35M (UHQ)	UHS-I U3 or higher
4K		4:2:2 10 150M, 150M 70M	
HD		4:2:2 10 70M (XHQ), 4:2:2 10 50M (XHQ), 50M (XHQ) 35M (UHQ)	
	QuickTime (MPEG2), MXF (MPEG2) 550	35M (HQ), 25M (SP)	
	Exchange (U model)	12M (LP), 8M (LP)	
	MP4 (H.264) (E model)	12M (LP), 8M (LP)	
SD	-	-	UHS-I U1 or higher, or Class 4 or higher
Web	-	-	

Caution :

- Using cards other than those from Panasonic, TOSHIBA or SanDisk may result in recording failure or data loss.

## Usable SSD Media

Refer to the “Instruction Manual” of the SSD Media Adapter that is inserted into [EXT.SLOT] for steps to mount the SSD media.

Caution :

- Please refer to the product information page on our website for a list of SSD media that have been tested for compatibility.

## Estimated Recordable Time of SD Cards

The estimated recordable time is only a guide. Differences may occur depending on the SD card in use and the battery condition.

- The recordable time varies according to the settings in [System], [A]Format], [A]Resolution], [A]Bit Rate] and [B]Resolution].  
(P150 [A]Resolution/ [EXT]Resolution)  
(P151 [A]Bit Rate/ [EXT]Bit Rate)  
(P152 [B]Resolution)

System	4K		
Format	QuickTime (H.264)		
Resolution	3840x2160		
Bit Rate	4:2:2 10 150M	150M	70M
8 GB	6	6	13
16 GB	12	12	26
32 GB	25	25	53
64 GB*	50	50	106
128 GB*	100	100	212
256 GB*	199	200	424
512 GB*	399	401	848

\* SDXC (Unit: minute)

System	HD, HD+Web (HD)			SD, HD +Web (Web)	HD+Web (Web)	
Format	QuickTime (H.264)					
Resolution	1920x1080	1920x1080, 1280x720	720x480, 720x576	960x540	480x270	
Bit Rate	XHQ (70M)	XHQ (50M)	UHQ	HQ	HQ	LP
8 GB	13	18	25	96	274	588
16 GB	26	36	51	194	556	1190
32 GB	52	73	103	391	1119	2396
64 GB*	105	147	207	785	2243	4804
128 GB*	210	295	415	1572	4495	9626
256 GB*	420	590	832	3147	8998	19270
512 GB*	839	1180	1664	6297	18004	38557

\* SDXC (Unit: minute)



System	HD			
Format	QuickTime (MPEG2) <b>550</b> , MXF (MPEG2) <b>550</b>		Exchange, MP4 (H.264)	
Resolution	1920x1080, 1440x1080, 1280x720	1440x1080	1920x1080	1280x720
Bit Rate	HQ	SP	LP (12M)	LP (8M)
8 GB	25	35	68	97
16 GB	51	70	139	197
32 GB	103	141	279	396
64 GB*	206	283	580	794
128 GB*	412	566	1121	1592
256 GB*	825	1133	2245	3186
512 GB*	1651	2267	4482	6376

\* SDXC (Unit: minute)

Memo : \_\_\_\_\_

- If the SD card contains files recorded by devices other than this camera recorder or files that are saved from a PC, the recordable time may be shorter or data may not be properly recorded.
- For each file format, up to 600 clips can be recorded to one SD card on this camera recorder. When 600 clips are recorded to one card, the remaining space is displayed as 0 min regardless of the estimated recordable time, and no further recording can be performed.
- When [System] is configured to “High-Speed”, the remaining time display for recording to the SD card will run out faster than usual.

### Write-Protect Switch on the SD Card

- ① Slide the write-protect switch upward to enable writing or deleting.
- ② Slide the write-protect switch downward to prevent writing or deleting. (Images in the card are protected.)

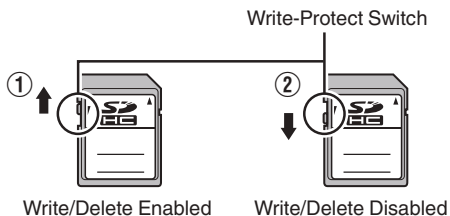

### Estimated Recordable Time of SSD Media

The estimated recordable time is only a guide. Differences may occur depending on the SSD media in use and condition of the battery.

- The recordable time varies according to the settings in [System], [EXT]Frame Rate], and [EXT]Bit Rate].

System	4K EXT (SSD)					
Format	ProRes					
Resolution	3840x2160					
Frame Rate	60p			50p		
Bit Rate	422HQ	422	422LT	422HQ	422	422LT
500 GB	34	50	72	40	60	86
1 TB	67	101	144	80	121	173
2 TB	134	201	289	161	241	346
Frame Rate	30p			25p		
Bit Rate	422HQ	422	422LT	422HQ	422	422LT
500 GB	67	100	144	80	120	172
1TB	134	201	288	161	240	345
2TB	268	402	576	321	481	690
Frame Rate	24p					
Bit Rate	422HQ	422	422LT			
500 GB	84	125	180			
1 TB	167	251	359			
2 TB	335	502	719			

(Unit: minute)

Memo : \_\_\_\_\_

- The maximum continuous recording time of “4K EXT (SSD)” is 4 hours. Recording stops upon exceeding 4 hours.

## Inserting an SD Card

This camera recorder comes with two card slots (Slot A and B) for video/audio recording and playback.

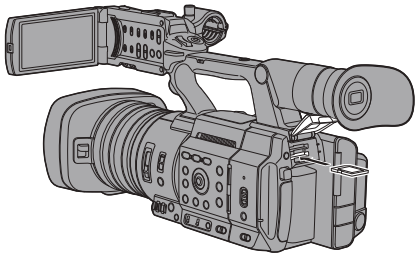

- 1 **Open the SD card cover.**
- 2 **Insert an SD card into the slot with the notched corner of the card on the right.**  
The status indicator of the card slot to which the card was inserted lights up in red.
- 3 **Close the SD card cover.**

## Card Slot Status Indicator

The following table shows the respective states of slot A and B.

Lamp	Slot Status
Lights up in red	The inserted SD card is being accessed. (writing/reading data) Do not turn off the power of the camera recorder or remove the SD card.
Lights up in green	On standby. The inserted SD card can be used for recording or playback.
Light goes out	<ul style="list-style-type: none"> <li>• SD card is not inserted.</li> <li>• An unusable card is inserted.</li> <li>• An SD card is inserted but a different slot is selected.</li> </ul>

## Removing the SD Card

- 1 **Check that the SD card to be removed is not being accessed (status indicator of the card slot lights up in red).**
- 2 **Open the SD card cover.**
- 3 **Push the SD card and remove it from the slot.**
- 4 **Close the SD card cover.**

Memo : \_\_\_\_\_

- When both slots are inserted with usable SD cards, the previously selected slot is used.

Caution : \_\_\_\_\_

- Data may be lost if you turn off the power of the camera recorder or remove the SD card when it is being accessed. All data recorded on the card, including the file that is being accessed, may be corrupted. Be sure to check whether the status indicator is lit in green or turned off before you turn off the power or remove the SD card.
- If you mistakenly remove the card when it is being accessed, reinsert the card only after the status indicator goes off.
- The SD card may not be recognized if you insert and remove the card within a short time. When this happens, remove the card and wait for a few seconds before you reinsert.

## Switching the SD cards

When both card slots are inserted with SD cards, you can use the [SLOT SEL] button to switch the card to use.

When the memory on an SD card is full during recording, data recording automatically switches to the other card.

Memo : \_\_\_\_\_

- The [SLOT SEL] button is disabled during recording or playback. Cards will not be switched even if you press the button.

## Inserting the SSD Media Adapter

This camera recorder comes with an [EXT.SLOT] for recording and playing audio sound and videos in "4K EXT (SSD)" quality.

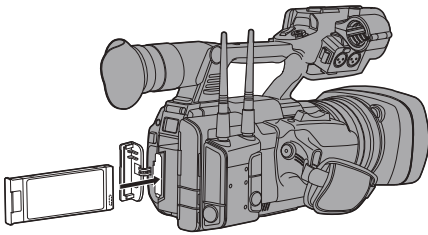

- 1 Turn off the camera recorder.
- 2 Detaching the Battery
- 3 Open the EXT.SLOT cover.
- 4 With the USB terminal of the SSD Media Adapter facing down, insert it into [EXT.SLOT].  
Insert it all the way until the tab locks into place.
- 5 Close the EXT.SLOT cover.
- 6 Attach the battery.
- 7 Turn on the camera recorder.

## Formatting (Initializing) of Recording Media

When any of the following recording media (SD card or SSD media) is inserted, [!FORMAT] appears in the remaining level display area.

Format the card using the camera recorder menu.

- Unformatted recording media
- Recording media formatted under different specifications

\* For details of the menu operation, refer to "[Basic Operations in Menu Screen] (P 107)".

Caution : \_\_\_\_\_

- Be sure to format the recording media on this camera recorder. Recording media formatted on a PC or other peripheral equipment cannot be used on this camera recorder.
- [!RESTORE] appears in the remaining level display area when a recording media that requires repair is inserted.

- 1 Select [System] → [Media] → [Format Media].  
(P 147 [Format Media])
- 2 Select the slot of the card to be formatted and press the Set button (●).



- 3 The status of the selected recording media is displayed.
- 4 Select [Format] and press the Set button (●).

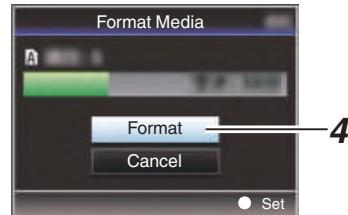

**5 Formatting starts.**



**6 Formatting is complete.**

When formatting is complete, "Complete" appears and the camera recorder returns to the [Format Media] screen.

Memo : \_\_\_\_\_

- The menu cannot be operated while formatting is in progress, but recording is possible to the slot where formatting is not executed.
- Formatting cannot be performed in the following cases.
  - When recording to the recording media to be formatted is in progress.
  - SD card is not inserted.
  - Write-protect switch of the SD card is set (🔒 is displayed).

Caution : \_\_\_\_\_

- If you format a recording media, all data recorded to it, including video data and setup files, will be deleted.

**Repairing the Recording Media**

It is necessary to restore the recording media if an abnormality occurs to the data in the recording media due to some reasons.

Memo : \_\_\_\_\_

- [!RESTORE] appears in the remaining level display area when a recording media that requires repair is inserted.

**1 Select [System] → [Media] → [Restore Media].**

(🔍 P147 [ Restore Media ] )

**2 Select the recording media to be restored and press the Set button (●).**



**3 Restoring starts.**

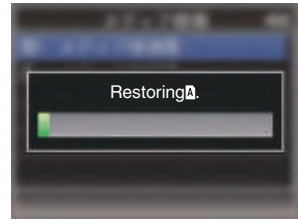

**4 Restoring is complete.**

- When restoring is complete, "Complete" appears and the camera recorder returns to the [Restore Media] screen.
- When no media that requires restoring is inserted, the camera recorder returns to the [Media] menu screen.

Caution : \_\_\_\_\_

- [Restore Media] can only be selected in Camera mode. However, it cannot be selected while the camera recorder is recording. Select [Restore Media] in Camera mode when the camera recorder is not recording.
- [Restore Media] does not restore the SD card to its original states completely. If restoring fails, replace or format the recording media. Take note that formatting erases all the information inside the SD card.
- Restoring cannot be performed in the following cases.
  - Camera recorder is recording in progress.
  - SD card is not inserted.
  - Write-protect switch of the SD card is set (🔒 is displayed).

## Clips Recorded to Recording Media

### Folders Created in the Recording Media

The captured image is recorded into different folders according to the [Format] settings.

- Other than MXF (MPEG2): [DCIM]
- MXF (MPEG2): [PRIVATE] **550**

Memo : \_\_\_\_\_

- By formatting (initializing) the recording media from the [Format Media] menu on the camera recorder, folders required for recording in the current [System] settings will be generated.
- When the [System] settings and [AFormat]/ [BFormat] settings are changed, folders required for recording in those settings will be automatically generated.

Caution : \_\_\_\_\_

- When a clip inside the folder is moved or deleted using the Explorer (Windows) or Finder (Mac), recording to the recording media may fail if formatting (initializing) of the media is not performed.

### Clip (Recorded Data) and Clip Name

- When recording is stopped, the images, audio and accompanying data which are recorded from start to stop are recorded as one "clip" on the recording media.
- An 8-character clip name is automatically generated for the recorded clip. ("Clip Name Prefix" + "Clip Number")

Example: QuickTime

ABCG0001

Clip Number

A number in automatic ascending order is assigned in the recording order.

The Clip Number can be reset in the menu.\*

Clip Name Prefix (any four alphanumeric characters)

This is set to "xxxG" ("xxx" denotes the last 3 digits of the serial number) by default.

- \* [Clip Set] ➔ [Reset Clip Number]  
(☞ P154 [ Reset Clip Number ] )

Memo : \_\_\_\_\_

- Before recording starts, you can set any characters for the clip name prefix by using [System] ➔ [Record Set] ➔ [Clip Set] ➔ [Clip Name Prefix].  
(☞ P154 [ Clip Name Prefix ] )
- Changes cannot be made after recording.

### Recorded Clips

- The recorded materials may be split into several files but they can be played back continuously on the camera recorder.
- Clips may be recorded across the two SD cards in card slots A and B depending on the recording time of the clip.

Caution : \_\_\_\_\_

- A clip recorded across several SD cards cannot be played back continuously. Continuous playback is only possible when the recording is made on one card.

# About the Operation Lock Feature (KEYLOCK)

You can use this feature to prevent erroneous camera operation.

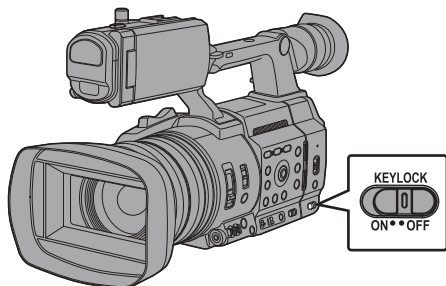

Operation lock does not apply to the following buttons and switches.

- [POWER ON/OFF] switch
- [ND FILTER] switch
- [TC IN/OUT] switch
- Focus Ring
- Zoom Ring
- Iris Ring
- Zoom Lever at the Grip
- Zoom Lever on Handle
- [FIX/VAR/OFF] switch

Memo : \_\_\_\_\_

- Operation lock does not apply to the REC button if “Keylock Except Rec” is selected in [Camera Function] → [KEYLOCK].  
(☞ P113 [ KEYLOCK ] )

## 1 Set the [KEYLOCK] switch to “ON”.

- The operation lock turns on, and an operation lock icon (🔒) appears on the display screen.
- The operation lock function is turned off when the [KEYLOCK] switch is set to “OFF”.

Memo : \_\_\_\_\_

- The operation lock feature is only valid in the Camera mode.  
(☞ P24 [Operation Modes] )
- The following remote operations are possible even when the operation lock feature is turned on (“On”).
  - Remote operation from the wired remote control connected to the [REMOTE] terminal.
  - Remote operation of the camera through access via a browser on devices such as a smartphone, tablet terminal, or PC.

# Basic Shooting Procedures

## Setting up

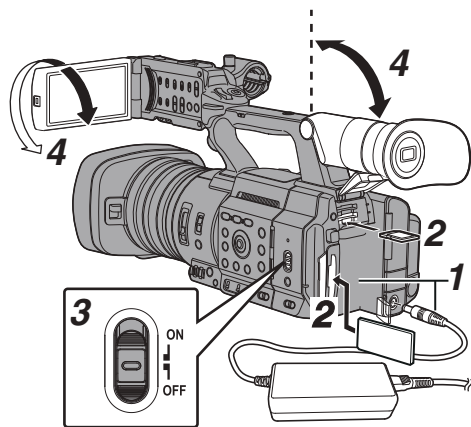

- 1 Supply battery or AC adapter power to the camera recorder.**  
(☞ P35 [Power Supply])
- 2 Insert the recording media**  
(☞ P48 [Recording Media])
- 3 Turn on the power of the camera recorder.**  
Setting the [POWER ON/OFF] switch to “ON” starts up the camera recorder in the Camera mode to enable shooting.
- 4 Adjust the angle of the LCD monitor and viewfinder.**  
(☞ P43 [Adjusting the LCD Monitor and Viewfinder])
- 5 Set [System], [Format], [Resolution], [Frame Rate] and [Bit Rate] in [System] → [Record Set] → [Record Format].**
  - You can select the definition of the recorded videos, file format for recording/playback, and the video recording format on this camera recorder.
  - Press the [MENU/THUMB] button to display the menu screen on the LCD monitor and viewfinder.

## Shooting

### 1 Configure the video and audio input settings.

You have to configure video settings such as brightness adjustment (iris, gain, shutter) and white balance adjustment in order to start shooting. You also have to adjust the audio input settings and audio recording level for audio recording.

- Adjusting the Brightness  
(☞ P64 [Adjusting the Brightness])
- Adjusting the White Balance  
(☞ P69 [Adjusting the White Balance])
- Adjusting Audio Input Settings and Recording Level  
(☞ P74 [Audio Recording])

### 2 Press the [REC] button to start recording to the recording media

The tally lamp lights up in red during recording.

- Zoom Operation  
(☞ P59 [Zoom Operation])
- Adjusting the Focus  
(☞ P60 [Focus Operation])

Memo :

- If both SD card slots A and B are loaded with recordable SD cards in the factory default state, pressing the [REC] button starts recording only to the media in the selected slot. Configuring [System] → [Record Set] → [Slot Mode] to “Dual” enables recording to be performed simultaneously to the SD cards in both slots A and B.  
(☞ P88 [Dual Rec])
- The tally lamp can be turned off in [System] → [Tally Lamp].

### 3 Check the most recently captured images.

- Press the user button that is assigned with the Clip Review function. Doing so activates the function and plays back the most recently captured images on the LCD monitor and viewfinder screen.
- After playback, the camera recorder returns to standby mode (STBY).  
(☞ P86 [Viewing Recorded Videos Immediately (Clip Review)])

# Selecting System Definition, File Format and Video Format

You can select the definition of the recorded videos, file format for recording/playback, and the video recording format on this camera recorder.

## Setting the Record Format Menu

- 1 **Set [System], [Format], [Resolution], [Frame Rate] and [Bit Rate] in [System] → [Record Set] → [Record Format].**
- 2 **Set each of the items.**
  - ① [Selecting a System Definition] (P 56)
  - ② [Selecting a File Format] (P 56)
  - ③ [Selecting a Video Format] (P 57)
  - ④ [Selecting the Aspect Ratio of SD Videos] (P 58)
- 3 **After setting is complete for all items, press the [[FOCUS ASSIST/1] button.**
  - The recording format is switched.
  - A “Please Wait...” message appears on the screen during switching.

## Selecting a System Definition

The following definitions are available for selection.

- 4K EXT:  
Records in 4K resolution (3840x2160)
- 4K:  
Records in 4K resolution (3840x2160)
- HD:  
Records in HD (High Definition) resolution (1920x1080, 1440x1080 or 1280x720)
- SD:  
Records in SD (Standard Definition) resolution (720x480 or 720x576)
- Web:  
Records in resolution (960x540, 720x480, 720x576, or 480x270) suitable for web distribution
- High-Speed:  
Records in HD resolution (1920x1080)

You can select a definition for the recorded images from the following items under [System].

- 4K EXT (SSD):  
Performs 4K EXT recording in EXT.SLOT.
- 4K:  
Records in 4K quality for both slots A and B.
- HD:  
Records in HD quality for both slots A and B.
- SD:  
Records in SD quality for both slots A and B.
- HD+Web:  
Records in HD quality for slot A, and Web quality for slot B.  
(P87 [Recording Simultaneously at Two Different Definitions])
- High-Speed:  
Records in HD quality for both slots A and B.

## Selecting a File Format

Select a file format in [A]Format/[B]Format. The following file formats are available for selection.

- QuickTime (MPEG2):  
QuickTime file format (.MOV)
- MXF (MPEG2):  
MXF file format
- QuickTime (H.264):  
QuickTime file format (.MOV)
- Exchange: (U model only)  
Sports Video Interop Group format (.MP4)
- MP4 (H.264): (E model only)  
MP4 file format

Memo :

- When [System] is set to “4K EXT (SSD)”, this item is fixed at “ProRes”.
- Exchange (U model) and MP4 (E model) are selectable only when [System] is configured to “HD”.
- When Exchange (U model) or MP4 (E model) is selected, backup recording and clip cutter function cannot be used.



## Selecting a Video Format

The selectable [Frame Rate]/[Bit Rate] changes according to the settings of [System]/[Format]/[Resolution].

### List of Formats

The following is a list of file formats and video formats that can be selected on this camera recorder.

- When [System] is set to “4K EXT (SSD)”

Record Format			
EXT Format	EXT Resolution	EXT Frame Rate	EXT Bit Rate
ProRes	3840x2160	60p, 50p, 30p, 25p, 24p	422HQ, 422, 422LT

Memo :

- [Rec Mode] is fixed at “Normal”.
- [Slot Mode] is fixed at “----”.
- The following functions cannot be used when 4K EXT (SSD) is selected.  
View Remote, Live Streaming, Return over IP or Overlay Function

- When [System] is set to “4K”

Record Format			
A Format	A Resolution	A Frame Rate	A Bit Rate
QuickTime (H.264)	3840x2160	30p, 25p, 24p	4:2:2 10P 150M, 150M, 70M

Memo :

- The following functions cannot be used when 4K is selected.  
View Remote, Live Streaming, Return over IP or Overlay Function
- Each item for slot B is fixed at the same setting as slot A.

- When [System] is set to “HD” or “HD+Web”, the options for slot A are:

Record Format			
A Format	A Resolution	A Frame Rate	A Bit Rate
QuickTime (MPEG2), MXF (MPEG2) 550	1920x1080	60i, 50i, 30p, 25p	35M (HQ)
	1440x1080	60i, 50i	35M (HQ), 25M (SP)
	1280x720	60p, 50p	35M (HQ)
QuickTime (H.264)	1920x1080	60p, 50p	4:2:2 10P 70M (XHQ), 4:2:2 10P 50M (XHQ), 50M (XHQ)
			60i, 50i, 30p, 25p, 24p
	1280x720	60p, 50p	4:2:2 10P 50M (XHQ), 35M (UHQ)
Exchange (U model)	1920x1080	60p	12M (LP)
	1280x720		8M (LP)
MP4 (H.264) (E model)	1920x1080	50p	12M (LP)
	1280x720		8M (LP)

Memo :

- When [System] is set to “HD”, each item for slot B is fixed at the same setting as slot A.
- When [System] is set to “HD+Web”, [Format] is fixed at “QuickTime(H.264)”.
- When [A]Format] is configured to “Exchange” or “MP4(H.264)”, selection is possible only when [System] is configured to “HD”.
- The following functions cannot be used when HD+Web is selected.  
View Remote, Live Streaming or Return over IP

■ When [System] is set to “High-Speed”

Record Format			
A Format	A Resolution	A Frame Rate	A Bit Rate
QuickTime (H.264)	1920x1080	120/60p, 100/50p	4:2:2 100, 70M (XHQ), 4:2:2 100, 50M (XHQ), 50M (XHQ)
		120/30p, 100/25p, 120/24p	4:2:2 100, 50M (XHQ), 50M (XHQ), 35M (UHQ)

Memo :

- [Rec Mode] is fixed at “Normal”.
- [Slot Mode] is fixed at “Series”.
- The following functions cannot be used when High-Speed is selected.  
View Remote, Live Streaming, Return over IP, Upload of recorded clip, time stamp recording, Face Detection or Overlay Function
- The settings for slot B are fixed at the same as slot A.
- Only “Rec Run” and “Regen” are the only TC generator settings available.
- It is not possible to set a shutter speed that is slower than the frame rate.
- The angle of view shifts to telephoto.  
(35 mm conversion: [Normal] 28.0 mm to 560.0 mm → [High-Speed] 56.1 mm to 1122 mm)
- The sensitivity of high speed shooting is lower than normal shooting. In order to capture more beautiful images, it is recommended to perform shooting in a lighted environment.
- The remaining space on the media (recordable time to the recording media) runs out faster than usual.  
(Example: For 120/60p, as the recording speed is twice as fast as usual, the remaining space on the media is reduced by approximately double the speed.)

■ When [System] is set to “SD”

Record Format			
A Format	A Resolution	A Frame Rate	A Bit Rate
QuickTime (H.264)	720x480	60i (U model)	8M (HQ)
	720x576	50i (E model)	

Memo :

- The following function cannot be used when SD is selected.  
Overlay Function
- Each item for slot B is fixed at the same setting as slot A.

■ When [System] is set to “HD+Web”, the options for slot B are:

Record Format			
B Format	B Resolution	B Frame Rate	B Bit Rate
QuickTime (H.264)	960x540	30p, 25p, 24p	3M (HQ)
	720x480	60i	8M (HQ)
	720x576	50i	
	480x270	30p, 25p, 24p	1.2M (LP)

Memo :

- The following functions cannot be used when HD+Web is selected.  
View Remote, Live Streaming or Return over IP

## Selecting the Aspect Ratio of SD Videos

For setting the aspect ratio of the SD recording image when [System] is set to “SD”.

You can select “16:9” or “4:3”.

( P152 [ SD Aspect ] )

Memo :

- For conditions other than those above, this item is fixed at “16:9”.

# Zoom Operation

Adjusts the angle of view.

Optical zoom ratio: 1x to 20x

Dynamic zoom ratio: 1x to 40x

Set using [Camera Function] → [Zoom] → [Dynamic Zoom].

(☞ P113 [ Dynamic Zoom ] )

Zooming can be operated using the following.

- Zoom Lever at the Grip
- Zoom Lever on Handle
- Zoom Ring at the Lens Section

During the zoom operation, the zoom bar or number will appear on the upper right corner of the screen.

(☞ P162 [Zoom Display] )

Caution : \_\_\_\_\_

- Depending on the zoom speed, the zoom drive noise of the power zoom may be recorded.

## Using the Zoom Lever at the Grip

### 1 Press the zoom lever to zoom.

- The zoom speed changes according to the extent the zoom lever is being pushed.
- Zooms into wide angle and increases the angle of view when “W” is pressed.
- Zooms into telephoto and decreases the angle of view when “T” is pressed.

## Using the Zoom Lever at the Handle

### 1 Set the [FIX/VAR/OFF] zoom speed switch to “FIX” or “VAR”.

Memo : \_\_\_\_\_

- Setting to “FIX” will allow the zoom operation to move at the speed set in [Handle Zoom Speed].
  - Set the zoom speed using [Camera Function] → [Zoom] → [Handle Zoom Speed]. (☞ P113 [ Handle Zoom Speed ] )

### 2 Press the zoom lever at the handle to zoom.

Memo : \_\_\_\_\_

- When the [FIX/VAR/OFF] zoom speed switch is set to “OFF”, the zoom lever at the handle section cannot be used.

## Using Zoom Ring at the Lens Section

You can adjust the preferred angle of view by turning the zoom ring.

## Saving/Recalling Current Zoom Position (Preset Zoom)

This allows you to register up to three zoom positions.

### 1 Assign the “Preset Zoom1”, “Preset Zoom2”, or “Preset Zoom3” function to any of the user buttons.

(☞ P46 [Assignment of Functions to User Buttons] )

(☞ P116 [USER1 to USER9, USER10 ▲, USER11 ▼, USER12 ◀, USER13 ▶] )

### 2 Save the current zoom position.

- Press any of the user buttons assigned with the “Preset Zoom1”, “Preset Zoom2”, or “Preset Zoom3” function for more than 1 second.
- The current zoom position will be stored.

### 3 Recall the stored zoom position.

- Press any of the user buttons assigned with the “Preset Zoom1”, “Preset Zoom2”, or “Preset Zoom3” function and release within 1 second.
- The camera recorder zooms to the stored zoom position.

Memo : \_\_\_\_\_

- Set the speed for shifting to the preset zoom position and the rate of change for starting and stopping the preset zoom operation in [Camera Function] → [Zoom] → [Preset Zoom] → [Speed]/[Ease In]/[Ease Out]. (☞ P114 [ Preset Zoom ] )
- Operating other zoom maneuvers during a zoom position recall will cancel the recall.

# Focus Operation

## Adjusting Focus Automatically

### 1 Set the [FOCUS AUTO/MANU] switch to "AUTO".

The auto focus icon **AF** appears on the screen.

Memo : \_\_\_\_\_

- When [Camera Function] → [Focus] → [AF Assist] is configured to "Direction", it is possible to move the auto focus point by turning the focus ring.  
(☞ P114 [ AF Assist ] )
- The AF area can be configured in [Camera Function] → [Focus] → [AF Area]. Selecting "Multi" displays a "Multi" icon, while selecting "Wide" shows a "Wide" icon.  
(☞ P114 [ AF Area ] )

### One Push Auto Focus

While in the Manual Focus mode, pressing the [PUSH AUTO] button (within 1 minute) makes the camera recorder focus on the center of the frame automatically.

Memo : \_\_\_\_\_

- Face detection does not work during One Push Auto Focus.
- AF Assist does not function.
- When the operation is complete, the camera recorder returns to the Manual Focus mode automatically.
- One Push Auto Focus functions with emphasis on the focusing speed. This function is not suitable during recording.

### Setting to Auto Focus Temporarily (Push Auto Focus)

- The camera recorder will shift to Auto Focus mode temporarily and automatically adjusts focus when the [PUSH AUTO] button is pressed during shooting in Manual Focus mode.
- Release the [PUSH AUTO] button to return to Manual Focus mode.

Memo : \_\_\_\_\_

- Face detection does not work during Push Auto Focus.

## Locking the Focus

While in the Auto Focus mode, pressing the [PUSH LOCK] button locks the focus on the corresponding point.

An **L** icon appears when the focus is locked.

Memo : \_\_\_\_\_

- Performing any focusing operation when the focus is locked disengages the focus lock.

## Adjusting Focus Manually

### 1 Set the [FOCUS AUTO/MANU] switch to "MANU".

The manual focus icon **MF** appears on the screen.

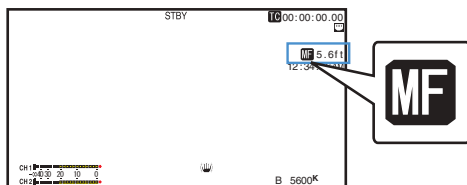

### 2 Turn the focus ring to adjust the focus.

Memo : \_\_\_\_\_

- Using the Focus Assist or Expanded Focus function makes it easier to focus.  
(☞ P61 [Focus Assist Function] )  
(☞ P62 [Expanded Focus Function] )
- Pressing the [PUSH AUTO] button in the Manual Focus mode activates the One-push Auto Focus mode, while holding down the [PUSH AUTO] button activates the Push Auto Focus mode.  
(☞ P60 [One Push Auto Focus] )  
(☞ P60 [Setting to Auto Focus Temporarily (Push Auto Focus)] )

## AF Assist Function

Configure this function to move the auto focus point closer to or away from the camera or to activate MF temporarily by turning the focus ring.

- Set [Camera Function] → [Focus] → [AF Assist].
  - Direction:
 

This option allows you to shift the auto focus point to near and far directions by turning the focus ring during AF.

Focus is automatically adjusted to a focus point near the position where the focus ring stops turning.
  - Manual:
 

Temporarily activates MF when the focus ring is turned during AF. The camera recorder returns to the AF mode when the focus ring is not operated for a some time.

## MF Assist Function

This function activates AF operation for a short interval when the focus ring is turned during MF.

- Set [Camera Function] → [Focus] → [MF Assist].
  - On:
 

Turning the focus ring during MF activates AF for a short interval after the operation, after which the camera recorder returns to the MF mode.

## Focus Assist Function

- When the [F.ASSIST/1] button is pressed during shooting, the focused area is displayed in color. This enables easy and accurate focusing.
- Select the color (blue, red or green) in the menu.

Memo :

- When [LCD/VF] → [Shooting Assist] → [Focus Assist] → [Type] is set to “ACCU-Focus”, the depth of field becomes shallower to enable easier focusing.  
(P126 [ Focus Assist ])
- The “ACCU-Focus” function switches automatically to “Off” after about 10 seconds.
- Select the display color in [LCD/VF] → [Shooting Assist] → [Focus Assist] → [Color].  
(P126 [ Color ])
- If you use the zebra function and the Focus Assist function at the same time, it may be difficult to see the effect of the Focus Assist. In this case, turn off the zebra function.

## Setting Focus Assist Function to a User Button

You can assign the “Focus Assist” function to a user button.

(P46 [Assignment of Functions to User Buttons])

## Focus Assist + Function

- You can operate the Focus Assist and Expanded Focus functions simultaneously by pressing the user button assigned with “Focus Assist +”.

Memo :

- “Expanded Focus” is displayed during the “Focus Assist +” operation regardless of the setting in [Camera Function] → [User Switch Set] → [Expanded Focus].

## Expanded Focus Function

You can magnify the preferred area by pressing the [EXP.FOCUS/9] button; doing so enables precise focus to be established easily.

\* You can also use the user button assigned with the “Expanded Focus” function instead of the [EXP.FOCUS/9] button.

(☞ P46 [Assignment of Functions to User Buttons])

(☞ P116 [USER1 to USER9, USER10 ▲, USER11 ▼, USER12 ◀, USER13 ▶])

### 1 Press the [EXP.FOCUS/9] button.

- The center area of the screen is enlarged for the first time.
- For subsequent operation of the button, the area at which the operation was last performed will be enlarged.



### 2 Use the cross-shaped button (▲▼◀▶) to magnify the preferred area.

- The portion that is being magnified is displayed at the lower right corner of the screen.

### 3 Press the [CANCEL] button to cancel the setting.

Memo : \_\_\_\_\_

- The display of the enlarged screen is dot by dot equivalent.
- To set the operation when the button is pressed, go to [Camera Function] → [User Switch Set] → [Expanded Focus].  
(☞ P117 [ Expanded Focus ] )
- Pressing and holding the Set button (●) resets the position of magnification.
- This function can be used together with the Focus Assist function.
- Magnifying an image does not alter the size of the recorded image.
- The cross-shaped button cannot be used as user button while the area is being magnified.
- This function is unavailable when [System] → [Record Set] → [Record Format] → [System] is set to “SD”.
- When the display screen is turned off, the magnified area at the bottom right of the screen will not be displayed.

## Adjusting the Focusing by Face Detection

This function detects human faces and automatically adjusts focus during Auto Focus. It can also track moving objects. When several faces are detected, you can select one to focus on.

Memo : \_\_\_\_\_

- This function can also adjust the brightness automatically according to the brightness of the face detected.

(☞ P115 [Face Detection Function Settings] )

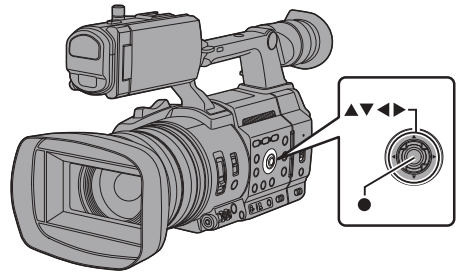

**1 Assign the “Face Detection” function to any of the user buttons.**

(☞ P46 [Assignment of Functions to User Buttons])

**2 Focus the camera recorder on a person and press the user button that is assigned with “Face Detection”.**

- When Face detection is enabled, the face detection icon (👤) appears.
- An orange frame will appear on the face of the person nearest to the center of the screen. Blue frames will appear on the faces of others.
- Focus will be automatically adjusted for the selected person.

Memo : \_\_\_\_\_

- When the button assigned with “Face Only AF” or the [Camera Function] → [Face Detection] → [Face Only AF] item is configured to “On”, “ONLY” appears to the right of the face detection icon, and auto focus functions only when a face is detected. When a face cannot be detected, the camera recorder switches manual focusing.

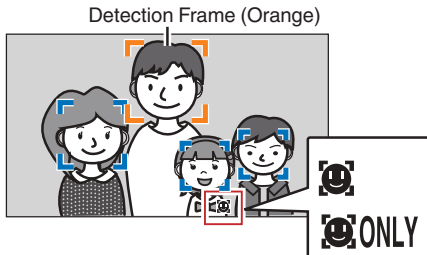

Memo : \_\_\_\_\_

- If the detection frame does not appear, make sure that Auto Focus mode is selected. Also, if [Face Detection] is set to “AF&AE”, set at least one of the iris, gain, and electronic shutter control items to the automatic adjustment mode. (☞ P64 [Adjusting the Brightness Automatically: Automatic Brightness Adjustment (AE) Mode]) (☞ P65 [Auto Iris (Automatic Adjustment) Mode]) (☞ P66 [Automatic Gain Mode (Automatic Gain Adjustment)]) (☞ P67 [Automatic Shutter Mode (Automatic Shutter Adjustment)])

**Selecting Specific Person from Several Persons**

**1 Hold down the user button that is assigned with “Face Detection”.**

- The camera recorder will enter face selection mode and the face detection icon (👤) will blink.
- An orange frame will appear on the face of the person nearest to the center of the screen. Blue frames will appear on the faces of others.

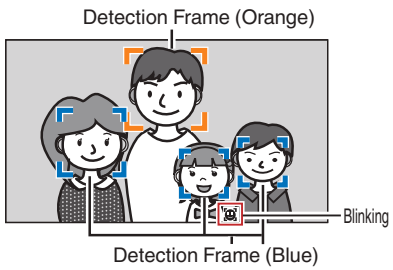

**2 Select a specific person.**

- Use the cross-shaped button (◀▶▲▼) to select a person.
- An orange frame will appear on the face of the selected person and focus will be automatically adjusted.

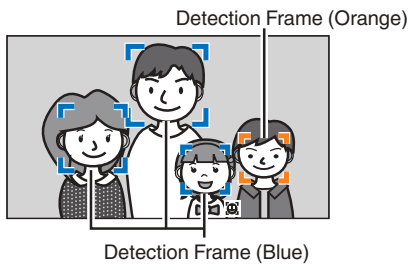

**3 Press the Set button (●) to confirm the person for face detection.**

Memo : \_\_\_\_\_

- Press the [CANCEL] button to cancel the selection.
- A face can be selected by turning the focus ring without entering the face selection mode.
- The detection sensitivity and duration for maintaining the current focus after losing sight of the face can be configured in [Camera Function] → [Face Detection] → [Sensitivity]/[Holding Duration]. (☞ P115 [Sensitivity]) (☞ P115 [Holding Duration])

# Adjusting the Brightness

Adjust the brightness using Iris, Gain, Shutter speed and ND filter according to the brightness of the object.

## Adjusting the Brightness Automatically: Automatic Brightness Adjustment (AE) Mode

Iris, Gain, Shutter speed and ND filter are automatically adjusted according to the brightness of the object to maintain optimum brightness. To set only the Iris, Gain and Shutter to Auto mode, set the [FULL AUTO] switch to "OFF" before setting each item to the automatic adjustment mode.

### 1 Set Gain, Iris and Shutter to Auto mode.

- [Adjusting the Iris] (☞ P 65)
- [Setting the Gain] (☞ P 66)
- [Setting the Electronic Shutter] (☞ P 67)

### 2 Set the target level (brighter/darker) to maintain optimum brightness during automatic adjustment.

- This can be configured using the cross-shaped button (◀▶) on the side of the camera recorder unit.
- This can be configured in [Camera Function] → [AE Level].

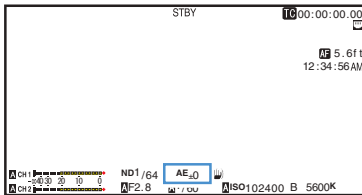

Memo : \_\_\_\_\_

- Setting the [FULL AUTO] switch to "ON" to enter the Full Auto mode also activates the automatic brightness adjustment (AE) mode. In this case, white balance is also switched forcibly to auto mode.
- The convergence speed of the automatic adjustment for automatic brightness adjustment (AE) can be set in the menu. (☞ P111 [ AE Speed ] )
- If one or more of the items (Gain, Iris and Shutter) have been set to Auto mode, the value of the corresponding items when the user button that is assigned "AE Lock" is pressed can be fixed. (☞ P117 [ AE Lock ] )
- If one or more of the items (Gain, Iris and Shutter) have been set to Auto mode, the automatic brightness adjustment (AE) mode is enabled.

## Adjusting the Brightness Manually

When the [FULL AUTO] switch is set to "OFF", some or all of the items (Iris, Gain and Shutter) can be manually adjusted.

### 1 Set the [FULL AUTO] switch to "OFF".

### 2 Adjust the Iris, Gain and Shutter speed.

- [Adjusting the Iris] (☞ P 65)
- [Setting the Gain] (☞ P 66)
- [Setting the Electronic Shutter] (☞ P 67)

Memo : \_\_\_\_\_

- The brightness cannot be manually adjusted in the Full Auto mode.
- If Iris, Gain and Shutter Speed are manually adjusted, the [AE Level] setting is temporarily disabled.



# Adjusting the Iris

Adjust the aperture of the lens iris according to the brightness of the subject.





## Auto Iris (Automatic Adjustment) Mode

- 1 Set the [FULL AUTO] switch to "OFF".
- 2 Press the [IRIS] button to set to the Auto Iris mode.

The iris is automatically adjusted according to the brightness of the object.

A  icon appears on the left side of the lens aperture value (F-number) during Auto Iris mode.

Memo : \_\_\_\_\_

- Setting the [FULL AUTO] switch to "ON" to enter Full Auto mode also activates the Auto Iris mode. In this case, the Gain, Shutter and White Balance also enter into Auto mode forcibly.
- The iris open/close limit can be set in [Camera Function] → [Auto Iris Limit (OPEN)][Auto Iris Limit (CLOSE)] during Auto Iris.  
( P112 [ Auto Iris Limit (OPEN) ] )  
( P112 [ Auto Iris Limit (CLOSE) ] )
- The control target level (brighter/darker) of the auto iris can be configured using the cross-shaped button () on the side of the camera recorder unit or in [Camera Function] → [AE Level].
- The convergence speed of the auto iris can be set in the menu.  
( P111 [ AE Speed ] )
- While in the Auto Iris mode, and [AE/FAW Lock] is set to "AE" or "AE/FAW", a  icon appears on the left side of the lens aperture value (F-number) during lock operation.

## Manual Iris (Manual Adjustment) Mode

The aperture value (F-number) of the lens can be set manually.

- 1 Set the [FULL AUTO] switch to "OFF".
- 2 Press the [IRIS] button to set to the Manual Iris mode.  
The lens aperture value (F-number) is displayed.

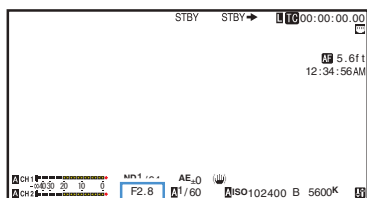

- 3 Turn the iris ring on the lens to adjust the iris manually.

The open F-number of the aperture varies according to the zoom position.

Wide [W] end : F2.8

Tele [T] end : F4.5

F-number	Description
Decrease	The subject appears brighter. The focused range becomes sharper, while the background is blurred to produce a soft image.
Increase	The subject appears darker. Background of image becomes focused as well.

- Memo : \_\_\_\_\_
- Pressing the [PUSH AUTO] button in the Manual Iris mode activates the One-push Auto Iris mode, while holding down the [PUSH AUTO] button activates the Push Auto Iris mode.

### One Push Auto Iris

When the camera recorder is in Manual Iris mode, press the [PUSH AUTO] button to adjust the iris according to the brightness of the object.

### Push Auto Iris

When the camera recorder is in the Manual Iris mode, press and hold the [PUSH AUTO] button to change to the Auto Iris mode temporarily. The iris will be automatically adjusted according to the brightness of the subject.

### About the Iris F-number

Blurry effects due to "small aperture diffraction" may occur when the diameter of the iris becomes too small. When this phenomenon occurs, the F-number on the screen turns gray to warn you that the diffraction F-number of the iris has been exceeded.

You are recommended to make appropriate use of ND filters to prevent the F-number from turning gray.

# Setting the Gain

This function electrically boosts the light sensitivity when there is insufficient illumination on the object. You can set the gain of the video amplifier according to the brightness of the object. Select the setting mode according to your shooting conditions.

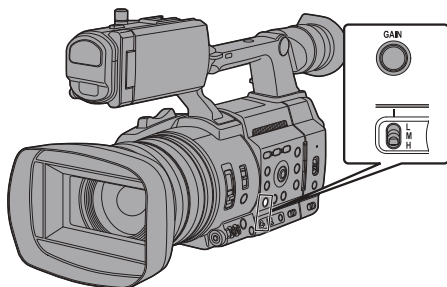

Shooting

## Automatic Gain Mode (Automatic Gain Adjustment)

- 1 Set the [FULL AUTO] switch to “OFF”.
- 2 Press the [GAIN] button to set to the AGC mode.

The gain of the video amplifier is automatically set according to the brightness of the subject. A **A** icon appears on the left side of the gain value in the AGC mode.

Memo : \_\_\_\_\_

- Setting the [FULL AUTO] switch to “ON” to enter the Full Auto mode also activates the Auto Gain mode. In this case, the Iris, Shutter and White Balance also enter into Auto mode forcibly.
- The switching operation of the [GAIN L/M/H] switch is disabled in the Full Auto mode.
- The upper limit of the gain setting value during AGC operation can be set in [Camera Function] → [AGC Limit].  
(P111 [ AGC Limit ])
- While in the Auto Gain mode, and [AE Lock] is set to “AE” or “AE/FAW”, a **L** icon appears on the left side of the gain value during lock operation.

## Manual Gain Mode (Manual Gain Switching)

- 1 Set the [FULL AUTO] switch to “OFF”.
- 2 Press the [GAIN] button to set to the manual gain mode, followed by selecting the [GAIN L/M/H] switch
  - Use the [GAIN L/M/H] switch to display the gain of the selected video amplifier.
  - The gain level appears on the screen.
  - The **A** icon on the screen disappears.

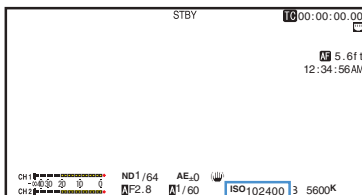

- The default positions of the switch are as follows.  
[L] : 0 dB  
[M] : 6dB  
[H] : 12dB

Memo : \_\_\_\_\_

- You can change the gain value of each position in the menu. Increasing the sensitivity causes the screen to appear grainier.  
(P112 [GAIN L, GAIN M, GAIN H])

# Setting the Electronic Shutter

You can change the shutter speed (time for each shooting frame) using the electronic shutter function. Electronic shutter can be adjusted manually or automatically.

## Automatic Shutter Mode (Automatic Shutter Adjustment)

- 1 Set the [FULL AUTO] switch to “OFF”.
- 2 Press the [SHUTTER] button to set to the **Automatic Shutter mode**.
  - The  icon appears on the screen.
  - Automatic Shutter mode adjusts the shutter speed automatically according to the brightness of the object.
- 3 Set the controllable range for the **Automatic Shutter in [Camera Function] → [EEI Limit]**.  
(☞ P112 [ EEI Limit ])

Memo : \_\_\_\_\_

- Setting the [FULL AUTO] switch to “ON” to enter the Full Auto mode also activates the Automatic Shutter mode. In this case, the Iris, Gain and White Balance also enter into Auto mode forcibly.
- In the Automatic Shutter mode, switching of shutter speed with the cross-shaped button (▲▼) at the side of the camera recorder and switching of shutter mode with the Set button (●) are disabled.
- While in the Automatic Shutter mode, and [AE/FAW Lock] is set to “AE” or “AE/FAW”, a  icon appears on the left side of the shutter speed during lock operation.

## Manual Shutter Mode (Manual Shutter Switching)

- 1 Set the [FULL AUTO] switch to “OFF”.
- 2 Press the [SHUTTER] button to set to the **Manual Shutter mode**.
  - The  icon on the screen disappears.
  - Use the Set button (●) to switch between the shutter modes and the cross-shaped button (▲▼) to switch between the speeds.

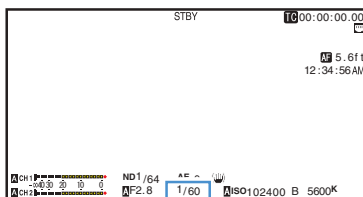

## Switching Shutter Mode

Press the Set button (●) to turn ON/OFF the shutter.



Memo : \_\_\_\_\_

- When the shutter is ON, configure the [Camera Function] → [Shutter] item to “Step” or “Variable”. “Step” is the factory default.  
(☞ P111 [ Shutter ])

## Switching Shutter Speed

When the shutter is ON, use the cross-shaped button (▲▼) to configure the shutter speed. The settable shutter speed range differs according to the video format setting.

Memo : \_\_\_\_\_

- To display Shutter in angle (DEG), set  [Frame Rate] to “25p” or “24p” and set [LCD/VF] → [Display Type] → [Shutter] to “DEG”.  
(☞ P151  [Frame Rate/ EXT] [Frame Rate])  
(☞ P111 [ Shutter ])

After the shutter speed indication turns white, the setting value can be changed using the cross-shaped button (▲▼).

■ For “Step”

Shutter Speed	Frame Rate				
	60p, 60i, 30p	50p, 50i, 25p	24p	120/60p, 120/30p, 120/24p	100/50p, 100/25p
1/10000	✓	✓	✓	✓	✓
1/4000	✓	✓	✓	✓	✓
1/2000	✓	✓	✓	✓	✓
1/1000	✓	✓	✓	✓	✓
1/500	✓	✓	✓	✓	✓
1/250	✓	✓	✓	✓	✓
1/120	✓	✓	✓	✓*	✓
1/100	✓	✓	✓	-	✓*
1/60	✓*	✓	✓	-	-
1/50	-	✓*	✓	-	-
1/48	-	-	✓*	-	-
1/30	✓	-	-	-	-
1/25	-	✓	-	-	-
1/24	-	-	✓	-	-
1/15	✓	-	-	-	-
1/12.5	-	✓	-	-	-
1/12	-	-	✓	-	-
1/7.5	✓	-	-	-	-
1/6.25	-	✓	-	-	-
1/6	-	-	✓	-	-

\* When the shutter is set to OFF

■ For “Variable”

Shutter Speed	Frame Rate		
	60p, 60i, 30p	50p, 50i, 25p	24p
Upper limit	1/9860	1/10118	1/9860
(Default value)	1/60.00	1/50.00	1/48.00
Lower limit	1/30.00	1/25.00	1/24.00

Shutter Speed	Frame Rate	
	120/60p, 120/30p, 120/24p	100/50p, 100/25p
Upper limit	1/9860	1/10118
(Default value)	1/120.0	1/100.0
Lower limit	1/120.0	1/100.0

Memo :

- The operations of the cross-shaped button (▲▼) and Set button (●) are disabled in the following cases.
  - During clip preview
  - During display of the formatting confirmation screen
  - When selecting a face using face detection
  - When selecting a photometry area with [Spot Meter] set to “Manual”
  - During expanded focus

## Setting the ND Filter

Use the ND filter to keep the lens aperture in the appropriate range.

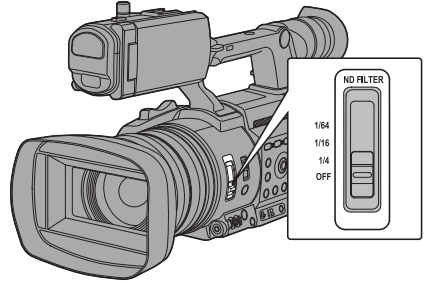

Switch according to the brightness of the object. When the position on the switch is changed, the selected position of the ND filter is displayed on the LCD monitor and viewfinder screen.

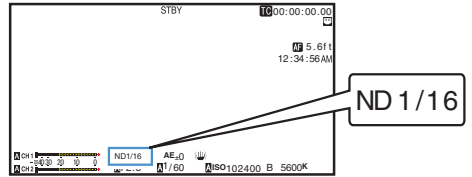

Memo :

- It is recommended to use the ND filter to set the lens aperture to less than F11.

### ND Filter Warning Display

In order to adjust the amount of light when you are shooting at a relatively bright location, the diameter of the iris may become extremely small, causing blurry effects to occur as a result. This phenomenon is known as “small aperture diffraction”. You can make appropriate use of ND filters to prevent it from occurring. This unit displays an ND filter warning when necessary to prompt you to select an appropriate ND filter.

- 1 Set [LCD/VF] → [Display Type] → [ND Filter] to “Normal + Assist”.  
(P129 [ ND Filter ])
- 2 When the iris diameter becomes too small while adjusting the light intensity, or when an ND filter is used in a dimly-lit location, the ND filter display starts blinking.

# Adjusting the White Balance

Adjust the white balance according to the color temperature of the lighting. You can select the adjustment mode according to the shooting conditions.

As the color of the light (color temperature) varies according to the light source, it is necessary to readjust the white balance when the main light source illuminating the subject changes.

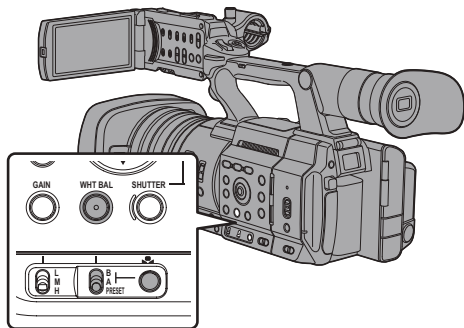

## Automatic White Balance Mode (FAW: Fulltime Auto White balance)

- 1 Set the [FULL AUTO] switch to “OFF”.
- 2 Press the [WHT BAL] button to set to Automatic White Balance mode.
  - “FAW” appears on the screen.
  - White balance switching with the [WHT BAL B/A/PRESET] selection switch is disabled.

Caution :

- The accuracy of [FAW] is inferior to that of [AWB] (Auto White Balance).
- When the power of the camera recorder is turned on with the [FAW] mode selected, it takes about 15 seconds for the colors to stabilize.

Memo :

- Setting the [FULL AUTO] switch to “ON” to enter the Full Auto mode also activates the Automatic White Balance mode. In this case, the Iris, Gain and Shutter also enter into Auto mode forcibly.
- When [Camera Function] → [User Switch Set] → [AE Lock] is set to “AE/FAW” or “FAW”, the white balance when the user button that is assigned with [AE Lock] is pressed can be fixed while in the Automatic White Balance mode. (☞ P117 [ AE Lock ])
- If [White Balance] is assigned to the user button, pressing the assigned user button will display the FAW Paint Adjustment screen. (☞ P46 [Assignment of Functions to User Buttons] )

## FAW Paint Adjustment

You can fine-adjust the white balance that was automatically adjusted.

- 1 Select [Camera Process] → [White Balance] → [FAW Paint] and press the Set button (●).  
The FAW Paint Adjustment screen appears.

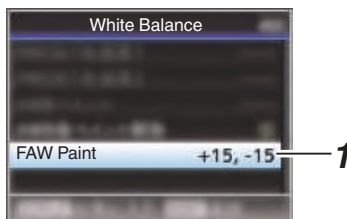

- 2 Adjust the R and B values.  
Use the cross-shaped button (▲▼) to adjust R value and (◀▶) to adjust B value.

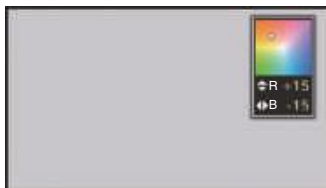

- 3 Press the **Set** button (●).  
Returns to the [White Balance] screen.

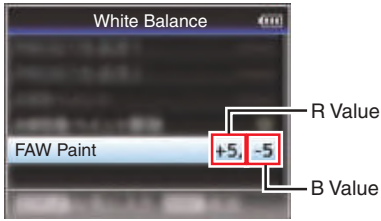

## Manual White Balance Mode (Manual Switching)

- 1 Set the [FULL AUTO] switch to "OFF".
- 2 Press the [WHT BAL] button to set to Manual White Balance mode.
  - Use the [WHT BAL B/A/PRESET] selection switch to select "PRESET" (preset mode), "A" (memory A mode), or "B" (memory B mode).

Memo : \_\_\_\_\_

- This is fixed at "FAW" when the [FULL AUTO] switch of the camera recorder is set to "ON".
- The FAW (Full Time Auto White Balance) mode makes automatic adjustments by sampling the color temperature of the video to obtain the most appropriate white balance level.

## Preset Mode (PRESET)

- Two different color temperature settings are registered on this camera recorder. You can switch between them using the [●] button or the user button assigned with the "AWB" function.

Default setting:

[Preset Temp.] : 3200K

[Alternative Temp.] : 5600K

- 1 Set the [WHT BAL] switch to "PRESET".
- 2 Press the [●] button or the user button assigned with the "AWB" function
  - The color temperature switches. ("Preset Temp." ↔ "Alternative Temp.")

## Setting the [Preset Temp.] or [Alternative Temp.] Values

You can change both the color temperature settings in the Preset mode in the menu.

- 1 Open the [Preset Temp.] or [Alternative Temp.] menu.

- Select [Camera Process] → [White Balance] → [Preset Temp.] and [Alternative Temp.], and press the **Set** button (●).
- The Color Temperature setting screen appears.

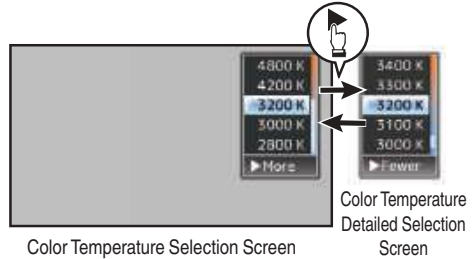

- 2 Select the color temperature.

- When selecting from a setting value (Color Temperature Selection screen), use the cross-shaped button (▲▼) to select the color temperature.  
[Setting Values: 7500K, 6500K, 5600K, 5200K, 4800K, 4200K, 3200K, 3000K, 2800K]
- To select detailed values (Color Temperature Detailed Selection screen)
  - Press the cross-shaped button (▶) to display the Color Temperature Detailed Selection screen.
  - Use the cross-shaped button (▲▼) to select a color temperature.  
[Setting Values: 2300K to 15000K (in 100K increments)]

Memo : \_\_\_\_\_

- Use the cross-shaped button (▶) to switch between the Color Temperature Selection screen and the Color Temperature Detailed Selection screen.
- If [White Balance] is assigned to the user button, pressing the assigned user button will display the Color Temperature Selection screen.  
(P46 [Assignment of Functions to User Buttons])

## Preset Paint Adjustment

The white balance for [Preset Temp.] and [Alternative Temp.] can be fine adjusted individually or collectively.

- 1 **Select [Camera Process] → [White Balance] → [Preset Paint Memory].**
  - “Common” configures the settings for the entire color temperature range collectively.
  - “Individual” configures the settings for the 9 types of color temperature individually.
- 2 **Select [Camera Process] → [White Balance] → [Preset Paint].**
  - The adjustment screen appears if “Common” is selected.
  - The lower color temperature limit of the color temperature range is displayed if “Individual” is selected. Select the color temperature to adjust.  
In the case of 2300K for example, the target range is 2300K to 2900K (less than 3000K)
- 3 **Adjust the R and B values.**
  - Use the cross-shaped button (▲▼) to adjust R value and (◀▶) to adjust B value.
- 4 **Press the Set button (●).**
  - In the case of “Common”, the display returns to the [White Balance] screen.
  - As for “Individual”, repeat steps 1 to 4 as necessary to configure each color temperature individually.

## Memory A Mode (A), Memory B Mode (B)

- Set to the white balance saved in Memory A or Memory B.
- When the [WHT BAL B/A/PRESET] selection switch is set to “A” or “B”, pressing the [●] button or the user button assigned with the “AWB” function executes Auto White Balance. White balance will be automatically adjusted and the adjusted value will be saved in Memory A or Memory B.

### 1 Prepare the camera recorder.

- ① Set the [POWER ON/OFF] switch to “ON”.
- ② Set the [FULL AUTO] switch to “OFF”.
- ③ Press the [IRIS] button to set to the Auto mode.

### 2 Set the [ND FILTER] switch according to the lighting.

(P68 [Setting the ND Filter])

### 3 Set the [WHT BAL B/A/PRESET] selection switch to “A” or “B”.

- 4 **Locate a place with similar lighting conditions as the object to be shot, place a white object near the center of the screen and zoom in to fill the screen with white.**
- 5 **Press the [●] button or the user button assigned with the “AWB” function**
  - The white detection frame appears when Auto White Balance is activated. Fill the frame with white completely.
  - While Auto White Balance is starting up, “A [●]” or “B [●]” appears on the screen. [●] mark appears blinking
  - After the correct white balance is obtained, an estimated value of the current color temperature is displayed.

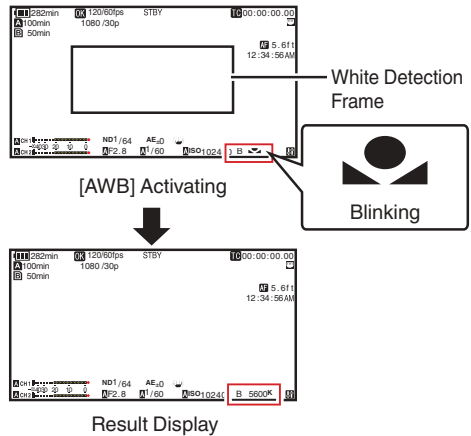

### Caution :

- Do not use highly reflective objects, such as metals. Doing so may result in improper white balance adjustment.
- The Auto White Balance function cannot provide optimum white balance with an object outside the adjustment range, for example when it contains only a single color or not enough white color.

### Error Message

If the Auto White Balance adjustment is not correctly completed, one of the following messages will appear for about 3 seconds.

Message	Status
Auto White * NG: Object (*A or B)	Displayed when there is not enough white color on the object, or when the color temperature is not suitable. Use another white object and adjust the white balance again.
Auto White * Error: Low Light (*A or B)	Displayed when the lighting is dark. Increase the lighting and adjust the white balance again.
Auto White * Error: Over Light (*A or B)	Excessive illumination. Displayed when the lighting is too bright. Decrease the lighting and adjust the white balance again.

### White Paint Adjustment

You can fine-tune the white balance saved in Memory A or Memory B.

- 1 Select [Camera Process] → [White Balance] → [AWB Paint] and press the Set button (●).**

The White Paint Adjustment screen appears.

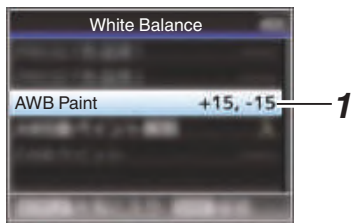

- 2 Adjust the R and B values.**

Use the cross-shaped button (▲▼) to adjust R value and (◀▶) to adjust B value.



- 3 Press the Set button (●).**

Returns to the [White Balance] screen.

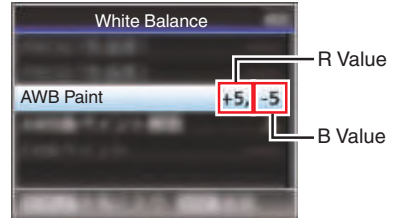

Memo : \_\_\_\_\_

- Executing Auto White Balance will usually clear the White Paint Adjustment value. But when [Camera Process] → [White Balance] → [Clear Paint After AWB] is set to "Off", values will not be cleared even when Auto White Balance is executed. (P123 [ Clear Paint After AWB ] )
- If [White Balance] is assigned to the user button, pressing the assigned user button will display the AWB Paint Adjustment screen. (P46 [Assignment of Functions to User Buttons] )



# Adjusting the Camera Image

The picture quality of the camera can be set using the [Camera Process] menu.

As the adjustments are shown on the screen, you can adjust the values while checking the picture quality on the camera.

- [Color Space]
- [Gamma]
- [Detail]
- [Master Black]
- [Black Toe]
- [Knee]
- [White Clip]
- [White Balance]
- [Color Matrix]
- [Color Gain]
- [Reverse Picture]

Memo : \_\_\_\_\_

- For details of the respective items, see the [Camera Process] menu.

(P118 [Camera Process Menu])

# Using the Image Stabilizer

Reduces blurring of images due to camera shake.

## 1 Check whether the image stabilizer feature is turned ON or OFF.

If the image stabilizer icon (📷/📷) does not appear on the screen display, the image stabilizer function is OFF.

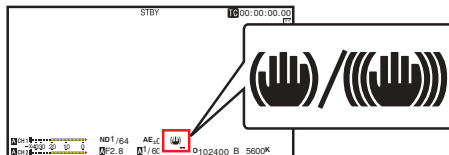

## 2 Press the [OIS/2] button to turn ON the image stabilizer feature (when image stabilizer feature is OFF).

The image stabilizer feature switches between ON and OFF with every press of the [OIS/2] button.

- OFF:  
Use this setting when the camera recorder is secured, such as when using a tripod.
- ON:  
Reduces blurring of images due to camera shake.

Memo : \_\_\_\_\_

- Select [Camera Function] → [OIS] → [Level] to set the correction level.  
(P111 [Level])
- Correction by this feature may not be sufficient when camera shake is too strong.
- “OIS” is assigned to the [OIS/2] button in factory default.
- “OIS” can also be assigned to other user buttons.  
(P46 [Assignment of Functions to User Buttons])

## About the Hard Lock Feature

Use this feature when blurry image caused by camera shake tends to occur due to strong acceleration.

It can be used to lock the IS (image stabilization) lens in place.

## 1 Press the [OIS/2] button to turn off the Image Stabilizer function

## 2 Set [Camera Function] → [OIS] → [Hard Lock] to “On”.

(P111 [Hard Lock])

Memo : \_\_\_\_\_

- Camera shake that causes image blur occurs when switching between On and Off.

# Audio Recording

You can record audio from the two channels (CH1/CH2) in synchronization with video images on this camera recorder.

Select from the options below to record the audio.

- Built-in Microphone
- Microphone connected to [AUX] terminal
- Microphone connected to [INPUT1] terminal
- Microphone connected to [INPUT2] terminal

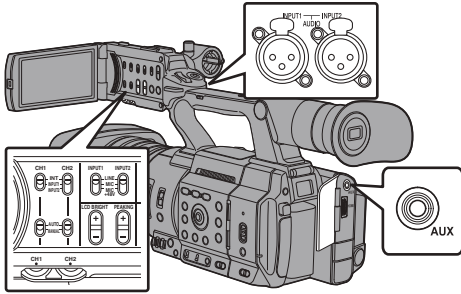

## Selecting Audio to Be Recorded in Each Channel

Select the audio to be recorded in CH1/CH2.

-	Switch Setting	Connected Devices
CH1	INT	<ul style="list-style-type: none"> <li>• Built-in Microphone</li> <li>• Microphone connected to [AUX] terminal</li> </ul>
	INPUT1	Microphone connected to [INPUT1] terminal
CH2	INT	<ul style="list-style-type: none"> <li>• Built-in Microphone</li> <li>• Microphone connected to [AUX] terminal</li> </ul>
	INPUT1	Microphone connected to [INPUT1] terminal
	INPUT2	Microphone connected to [INPUT2] terminal

Memo :

- When “INT” is set, the built-in microphone is disabled if a microphone is connected to the [AUX] terminal; audio from the microphone connected to the [AUX] is recorded.
- When “INT” is selected, set the reference input level in [Main Menu] → [A/V Set] → [Audio Set] → [Int. Mic Gain]/[AUX Gain].  
(P132 [ Int. Mic Gain ] )  
(P132 [ AUX Gain ] )

## Setting Input Channel to [INPUT1]/[INPUT2]

Select the audio to input to [INPUT1] and [INPUT2] terminals with the [INPUT1]/[INPUT2] mode switch.

Setting	Description
[LINE]	Use this setting when connecting to an audio device or other equipment. The reference input level is +4 dBu.
[MIC]	Use this setting when connecting to a dynamic microphone.
[MIC+48V]	Use this setting when connecting to a microphone (phantom microphone) that requires a +48 V power supply.

Memo :

- When “MIC” or “MIC+48V” is selected, set the reference input level in [A/V Set] → [Audio Set] → [Input1 Mic Ref.]/[Input2 Mic Ref.].  
(P132 [ Input1 Mic Ref. ] )  
(P132 [ Input2 Mic Ref. ] )

Caution :

- When connecting a device that does not require a +48 V power supply, make sure that it is not set to the “MIC+48V” position.
- When the [INPUT1]/[INPUT2] mode switch is set to “MIC”, make sure that a microphone is connected to the [INPUT1]/[INPUT2] terminal. If you increase the recording level when a microphone is not connected, noise from the input terminal may be recorded.
- When a microphone is not connected to the [INPUT1]/[INPUT2] terminal, set the [INPUT1]/[INPUT2] mode switch to “LINE” or adjust the volume with the [CH1]/[CH2] recording level adjustment knob.

## Adjusting Audio Recording Level

You can select to adjust the audio recording levels for the two channels (CH1/CH2) manually or automatically.

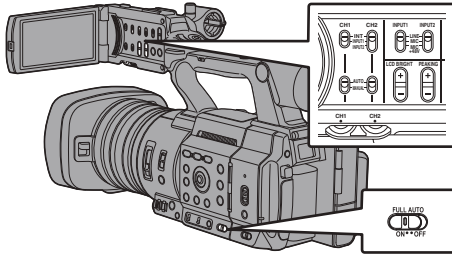

### Manual Adjustment Mode (Manual Adjustment)

- Set the [CH1/CH2 AUTO/MANUAL] switch on the camera recorder to “MANUAL” to enter the manual adjustment mode, and use the [CH1]/[CH2] recording level adjustment knob to set the recording level.
- You can adjust the level manually during the recording, recording standby, and stop modes.

- When the input channel is set to “INPUT1”/“INPUT2”

- 1 Set the [CH1/CH2 AUTO/MANUAL] selection switch to “MANUAL” for the channel to be adjusted manually.
- 2 Turn the corresponding [CH1]/[CH2] recording level adjustment knob to adjust the level.

When [A/V Set] → [Limiter] is set to “Off”, adjust such that the audio level meter does not light up at -2 dB even for loud sounds.  
(☞ P132 [Limiter])

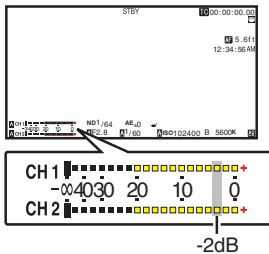

- When the input channel is set to “INT” for both [CH1] and [CH2]

- 1 Set the [CH1 AUTO/MANUAL] selection switch to “MANUAL”.
- 2 Turn the [CH1] recording level adjustment knob to adjust the level.  
When the built-in microphone and the [AUX] input terminal are used, the recording levels of [CH1] and [CH2] are interlocked. This is also effective when the [CH1 AUTO/MANUAL] selection switch is set to [CH2].

Memo : \_\_\_\_\_

- Select [Limiter], [AGC Response], [AGC Mode], or [Int. Mic Separation] in the menu to set the recording audio.
- If [Limiter] is set to other than “Off”, the limiter operates according to the value set.  
(☞ P132 [Limiter])
- For the reference level to be recorded to an SD card, set [A/V Set] → [Audio Set] → [Ref. Level] to “-20dB”, “-18dB”, or “-12dB”. (common for CH1/CH2)  
(☞ P132 [Ref. Level])
- The operations of the [CH2] recording level adjustment knob and [CH2 AUTO/MANUAL] selection switch are disabled.

### Automatic Adjustment Mode

- Set the [CH1/CH2 AUTO/MANUAL] selection switch to “AUTO” or the [FULL AUTO] switch to “ON” to enter Automatic Adjustment mode. The audio recording level is set automatically according to the input level.
- When the [FULL AUTO] switch is set to “ON”, mode switching with the [CH1/CH2 AUTO/MANUAL] selection switch is disabled.

Memo : \_\_\_\_\_

- When [A/V Set] → [Audio Set] → [Limiter] is set to “Off” while in the automatic adjustment mode, the limiter operates at -6dBFS.  
(☞ P132 [Limiter])
- When [A/V Set] → [Audio Set] → [Audio On FULL AUTO] is set to “SW Set”, you can switch the audio recording mode with the [CH1/CH2 AUTO/MANUAL] selection switch on the camera recorder even when the [FULL AUTO] switch is set to “ON”.  
(☞ P134 [Audio On FULL AUTO])

# Monitoring Audio Sound During Recording Using a Headphone

You can check the recorded audio using headphone.

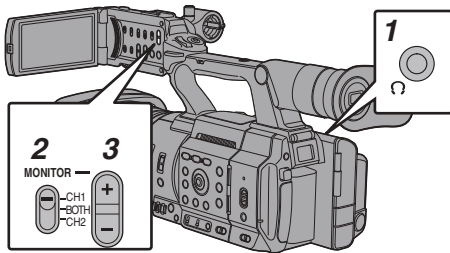

- 1 Connect the headphone.
- 2 Select the channel to monitor with the [MONITOR] selection switch.

Setting	Description
[CH1]	Outputs the audio recorded in [CH1].
[BOTH]	Outputs the audio recorded in [CH1/CH2].
[CH2]	Outputs the audio recorded in [CH2].

- 3 Use the [MONITOR +/-] button to adjust the monitor volume.

Memo : \_\_\_\_\_

- Audio during recording is not output from the monitor speaker.
- Warning tone is output when there is an abnormality in the camera recorder or when the battery is low.  
(☞ P236 [Warning Tone])

## Selecting Audio Output Method When the [MONITOR] Selection Switch Is Set to "BOTH"

When a stereo type earphone jack is connected, perform the following setting to output stereo sound.

- 1 Set the [MONITOR] selection switch to "BOTH".
- 2 Set [A/V Set] → [Audio Set] → [Monitor] to "Stereo".  
(☞ P134 [Monitor])

Memo : \_\_\_\_\_

- You can set the volume of the warning tone in [A/V Set] → [Audio Set] → [Alarm Level]. ("Off"/"Low"/"Middle"/"High")  
(☞ P134 [Alarm Level])

# Time Code and User's Bit

Time code and user's bit data are recorded with the video in this camera recorder. The time code and user's bit are displayed on the viewfinder and LCD monitor during playback or recording. (Display screen)

## Displaying Time Code and User's Bit

The time code and user's bit are displayed on the viewfinder and LCD monitor during playback or recording. The display differs according to the menu settings.

- 1 Set [LCD/VF] → [Display On/Off] → [TC/UB] to "On".  
(☞ P129 [Display On/Off Item])
- 2 Set [LCD/VF] → [Display Type] → [TC/UB].  
When "TC" or "UB" is selected, time code or user's bit data is displayed respectively on the display screen.  
(☞ P128 [TC/UB])

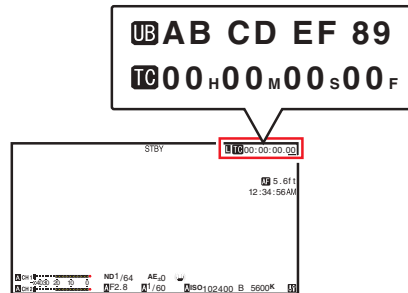

## Time Code Operation Mode

Set the time code operation in [TC/UB] → [TC Generator].

(☞ P124 [ TC Generator ] )

Setting	Description
Free Run(GPS) SPC	Time code information can be synchronized with the date/time information acquired from the GPS.
Free Run(Ext)	This mode synchronizes another camera recorder connected to the [TC] terminal. The time code operates in the run mode at all times regardless of the recording status. It continues to run even when the power of the camera recorder is turned off.
Free Run	The time code operates in the run mode at all times regardless of the recording status. It continues to run even when the power of the camera recorder is turned off.
Rec Run	The time code operates in the run mode during recording. It continues to run in the order of the recorded clips as long as the SD card is not replaced. If the SD card is removed and recording is made on another card, time code will be recorded on the new card from where it was left off in the previous card.
Regen	The time code operates in the run mode during recording. When the SD card is replaced, the last time code recorded on the card is read and recorded on a new card so that the time code continues in running order. (☞ P78 [Setting Time Code] )

- Memo : \_\_\_\_\_
- When [System] → [Record Set] → [Rec Mode] is set to "Interval Rec" or "Frame Rec", and [TC Generator] is set to "Free Run" or "Free Run(Ext)", "Rec Run" is activated.
  - When [System] → [Record Set] → [Record Format] → [System] is set to "High-Speed", and [TC Generator] is set to "Free Run" or "Free Run(Ext)", "Rec Run" is activated.

## Setting Time Code Generator

### Presetting the Time Code

Time code and user's bit data generated from the internal time code generator are recorded. This section describes how to set [TC/UB] → [TC Preset].

(☞ P124 [ TC Preset ] )

Memo : \_\_\_\_\_

- When [System] → [Record Set] → [Record Format] → [A]Frame Rate] is set to "50p", "50i", "25p" or "24p", setting for "Drop" will be disabled.  
(☞ P151 [A]Frame Rate/ [EXT]Frame Rate] )
- You can configure the setting without accessing the [TC/UB] menu screen.  
(☞ P79 [Setting Time Code without Opening the Menu] )

### Required Settings Before Preset

#### 1 Set [TC/UB] → [TC Generator] to "Rec Run" or "Free Run".

(☞ P124 [ TC Generator ] )

- [Rec Run]:  
Preset data in the time code generator operates in run mode during recording mode. Set this when recording continuous time code in connecting frames.
- [Free Run]:  
Time code starts to operate in run mode from the preset time in the time code generator.

## 2 Select the framing mode for the time code generator (only when the frame rate setting is “60” or “30”).

To configure the setting, go to [TC/UB] → [Drop Frame].

( P124 [ Drop Frame ] )

- [Drop]:

Sets the run mode of the time code generator to drop frame mode. Use this setting when placing emphasis on the recording time.

- [Non Drop]:

Sets the run mode of the time code generator to non-drop frame mode. Use this setting when placing emphasis on the number of frames.

Memo : \_\_\_\_\_

### Drop frame/non-drop frame mode

- When [System] → [Record Set] → [Record Format] → [Frame Rate] is set to “60p”, “60i”, or “30p”, the actual number of frames per second is approximately 59.94 (29.97). However, the time code processing standard is “60p”, “60i”, or “30p” frames. To make up for the frame number discrepancy, the drop frame mode (Drop) drops the 00 frame and 01 frame every minute except for minutes that are multiples of 10. However, in the case of “60p”, the 00, 01, 02 and 03 frame are dropped.
- The non-drop frame mode (Non Drop) does not drop frames and ignores the discrepancy with the actual time.

## Setting Time Code

### 1 Select [TC/UB] → [TC Preset] and press the Set button (●).

( P124 [ TC Preset ] )

The [TC Preset] screen appears.

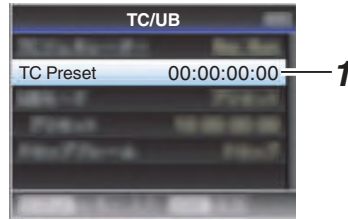

Memo : \_\_\_\_\_

- When [TC/UB] → [TC Generator] is set to “Regen”, the parameter is displayed as “<Regen>” and cannot be selected. ( P124 [ TC Generator ] )

### 2 Set the time code (hour, minute, second, frame).

Use the cross-shaped button (◀▶) to place the cursor at the item to set, then use the cross-shaped button (▲▼) to change the values.

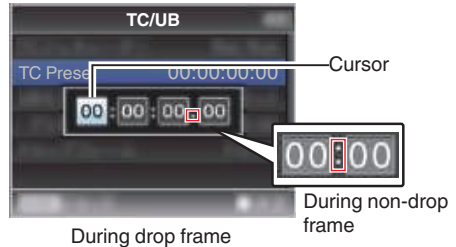

Memo : \_\_\_\_\_

- Press the [OIS/2] button to reset each digit to “0”. The cursor moves to the time digit (left).

### 3 Check the values and press the Set button (●).

- The time code is set and the screen returns to [TC/UB].
- To cancel the setting, press the [CANCEL] button.

### 4 Press the [MENU/THUMB] button.

Returns to the normal screen.

## Setting Time Code without Opening the Menu

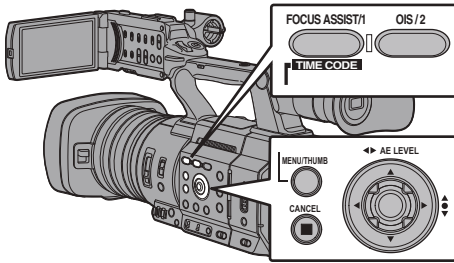

Memo : \_\_\_\_\_

- Settings cannot be made in the following cases.
  - [TC/UB] → [TC Generator] has been set to “Regen”.
  - Menu screen is displayed.
  - The camera recorder is not in the Camera mode.

### Setting Time Code

- 1 Set [TC/UB] → [TC Generator] to a value other than “Regen”.  
(☞ P124 [ TC Generator ])
- 2 Hold down the [MENU/THUMB] button and press the [FOCUS ASSIST/1] button. The [TC Preset] setting screen appears.

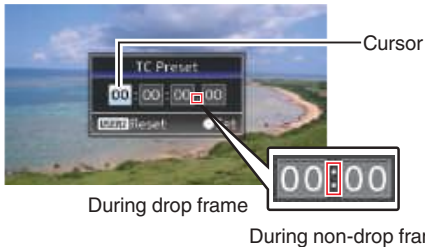

- 3 Set the time code (hour, minute, second, frame).  
Use the cross-shaped button (◀▶) to place the cursor at the item to set, then use the cross-shaped button (▲▼) to change the values.

Memo : \_\_\_\_\_

- Press the [OIS/2] button to reset each digit to “0”.  
The cursor moves to the time digit (left).

- 4 Check the values and press the Set button (●).

- The time code is set and the screen returns to the normal screen.
- To cancel the setting, press the [CANCEL] button.

Caution : \_\_\_\_\_

- When the camera recorder is switched to Media mode during editing, editing will be canceled and the screen will close.
- When editing the time code, operation of the buttons that are set in [Camera Function] → [User Switch Set] is disabled. [OIS/2] functions as the number reset button.  
(☞ P116 [ User Switch Set Item ])

### Recording Time Code in Continuation of the Recorded Time Code on SD Card

This camera recorder is equipped with the time code reader.

- 1 Set [TC/UB] → [TC Generator] to “Regen”.
  - When the camera recorder enters from recording standby mode to recording mode, it reads the time code already recorded on the SD card and records the new time code in continuation of that value.
  - The same data as the user’s bit already recorded on the SD card is recorded.

Memo : \_\_\_\_\_

- When [TC/UB] → [TC Generator] is set to “Regen”, the framing mode of the time code follows the settings in [TC/UB] → [Drop Frame] instead of the clip settings.  
(☞ P124 [ Drop Frame ])

# Setting the User's Bit

You can add the date, time or an 8-digit hexadecimal number as the user's bit to the recorded image.

## Selecting a Recording Mode

**Recording date/time information to the user's bit**

1 Set [TC/UB] → [UB Mode] to "Date" or "Time", and press the Set button (●).

(☞ P124 [ UB Mode ])

The date or time information is recorded to the user's bit.

Memo : \_\_\_\_\_

- When "Date" or "Time" is set, [Preset] appears as "." and cannot be set.
- "Time" is displayed in the 24-hour format.

## Presetting the User's Bit

**Recording arbitrary information (8-digit hexadecimal) to the user's bit**

1 Set [TC/UB] → [UB Mode] to "Preset", and press the Set button (●).

(☞ P124 [ UB Mode ])

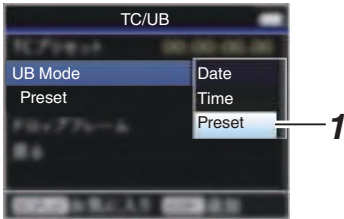

Memo : \_\_\_\_\_

- When [TC/UB] → [TC Generator] is set to "Regen", the parameter is displayed as "<Regen>" and cannot be selected.

(☞ P124 [ TC Generator ])

2 Select [TC/UB] → "Preset" and press the Set button (●).

The [Preset] setting screen appears.

3 Use the cross-shaped button (◀▶) to place the cursor at the item to set, then use the cross-shaped button (▲▼) to change the values.

Numbers between 0 and 9 or alphabets between A and F can be specified for the user's bit.

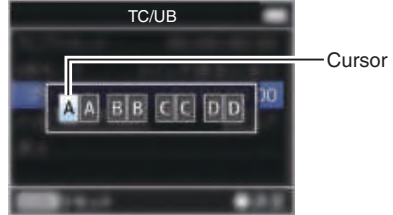

Memo : \_\_\_\_\_

- Press the [OIS/2] button to reset each digit to "0". The cursor moves to the left.

4 Check the values and press the Set button (●).

- The user's bit is set and the screen returns to [TC/UB].
- To cancel the setting, press the [CANCEL] button.

5 Press the [MENU/THUMB] button.

Returns to the normal screen.



# Synchronizing Time Code on Another Camera

This camera recorder is equipped with a time code input/output terminal ([TC] terminal). Connect another camera recorder to the [TC] terminal and synchronize to the time code.

- 1 Connect the [TC] terminal of the master device with the [TC] terminal of the slave device.**  
Set the [TC IN/OUT] switch of the master device to "OUT", and the [TC IN/OUT] switch of the slave device to "IN".

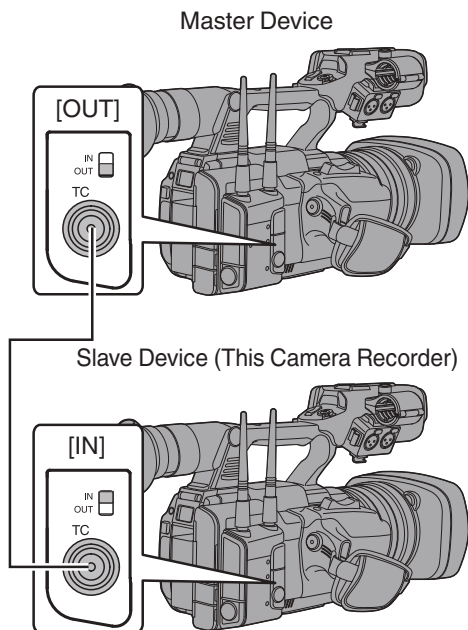

## Settings and Operation of the Camera Recorder

- 1 Set to Camera mode.**  
( P24 [Operation Modes] )
- 2 Set [TC/UB] → [TC Generator] as follows.**
  - Slave device:  
Select "Free Run(Ext)".
  - Master device:  
Select "Free Run".
- 3 Set LCD monitor or viewfinder to Display screen.**
- 4 Set the master device and run the time code.**
  - When the built-in time code generator is synchronized with the external time code data input, the icon on Display screen lights up.
  - When time code is not synchronized or time code input is not available, the icon goes out.

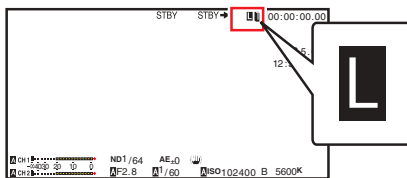

Memo :

- The built-in time code generator will continue operation even when the master device is disconnected after synchronization.
- User's bit will become data in the master device.

# Setting Zebra Pattern

When the luminance level range for displaying zebra patterns is specified, diagonal lines (zebra pattern) are displayed at areas with the specified luminance levels during shooting.

## 1 Set [LCD/VF] → [Shooting Assist] → [Zebra] to “On”.

(☞ P126 [ Zebra ] )

## 2 Specify the brightness (luminance) level range for displaying zebra pattern.

Specify the upper and lower limits of the luminance level in [LCD/VF] → [Shooting Assist] → [Zebra] → [Top] and [Bottom].

Item	Settings	Options
Top	Upper luminance limit for displaying [Zebra]	5%, 10% to 95%, 98%, 100%, Over
Bottom	Lower luminance limit for displaying [Zebra]	0%, 5% to 95%, 98%, 100%

Memo :

- The timing to detect the zebra pattern display can be configured only when “J-Log1” or “HLG” is selected in [Color Space] and “Cam” or “Cam + Return” is selected in [Convert to ITU709].

(☞ P118 [ Color Space ] )

(☞ P125 [ Convert to ITU709 ] )

(☞ P126 [ Detect ] )

## 3 Display the zebra pattern.

Press the [ZEBRA/5] button to display the zebra pattern in the specified range.



During zebra pattern display,  (zebra icon) is displayed on the display screen in Camera mode.

Memo :

- “Zebra” is assigned to [ZEBRA/5] button in factory default.
- “Zebra” can also be assigned to other user buttons.  
(☞ P46 [Assignment of Functions to User Buttons] )

# Setting Spot Meter

The brightness of the object during shooting is displayed.

This function is useful when setting video or stage lighting or when specifying camera exposure.

A cursor indicating the location and the brightness (%) of that location are displayed in the images shown on the LCD monitor and viewfinder screen.

- Zebra patterns display the brightness of output video signals.

( P82 [Setting Zebra Pattern] )

- This function allows you to check the brightness of input images from the lens without depending on image processing such as gamma curve.
- When [Color Space] is set to a value other than “HLG” and “J-Log1”, the dynamic range of the camera recorder is max. 400% and a brightness range of 0% to 400% is displayed.
- The value of the spot meter changes according to the setting of [LCD/VF] → [Convert to ITU709]/[White Level] when [Color Space] is set to “HLG”.

When [Color Space] is set to “HLG” and [LCD/VF] → [Convert to ITU709]/[White Level] is set to “72.5%”, the dynamic range of the camera recorder is max. 458% and a brightness range of 0% to 458% is displayed.

- When [Color Space] is set to “J-Log1”, the dynamic range of the camera recorder is max. 800% and a brightness range of 0% to 800% is displayed.

Memo : \_\_\_\_\_

- Spot meter may not be consistent with the zebra display range.

## 1 Select one of the following from [Camera Function] → [User Switch Set] → [Spot Meter].

( P116 [ Spot Meter ] )

Item	Settings	Color of Frame Indicating the Position
Max & Min	Displays the brightness (%) and positions of the brightest and darkest areas in the screen. Frames may also be stopped at the current positions.	<ul style="list-style-type: none"> <li>• Max: Green</li> <li>• Min: Yellow</li> </ul>
Max	Displays the brightness (%) and position of the brightest area in the screen. Frames may also be stopped at the current positions.	Green
Min	Displays the brightness (%) and position of the darkest area in the screen. Frame may also be stopped at the current positions.	Yellow
Manual	Displays the brightness (%) of the specified position.	Green (Blinks in green when specifying the position)

## 2 Assign the “Spot Meter” function to any of the user buttons.

( P46 [Assignment of Functions to User Buttons] )

## 3 Press the user button that is assigned with “Spot Meter”.

The operation switches as below when the button is pressed.

### When [Max & Min]/[Max]/[Min] is selected

- ① The cursors appear according to the setting when the button is pressed. Green and yellow frames appear, and the brightness levels of these areas are displayed.

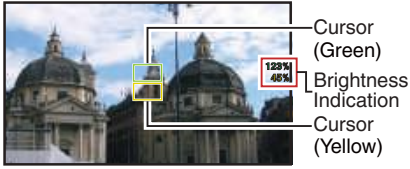

- ② Hold down the button in the state in ①, the positions of the brightest (Max) and darkest (Min) areas in the screen are automatically detected with regard to the changes of the object, and the brightness level of these areas are displayed.

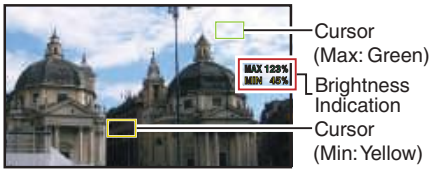

- ③ Pressing the button in the state in ② stops the automatic position detection. The frames are fixed at the stopped positions and the brightness levels are displayed.
- ④ By pressing the button, the cursors and brightness indication disappear.



### When [Manual] is selected

- ① The brightness of the cursor position is displayed when the button is pressed.

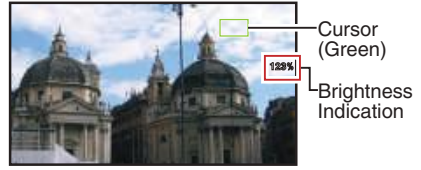

- ② By pressing the button, the cursors and brightness indication disappear.



- ③ Hold down the button in the state in ① or ②, the cursor blinks in green. Move the cursor with the cross-shaped button (▲▼◀▶) to specify the position to display the brightness. When you decide on the position, press the Set button (●) to confirm.

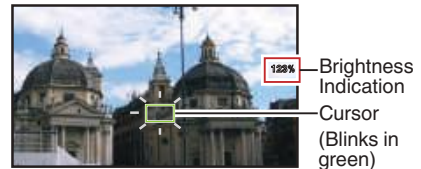

- ④ Frames are fixed at the stopped positions and the brightness is displayed.

Memo : \_\_\_\_\_

- When moving the cursor position, [Shutter]/[AE Level] control is disabled.
- When the brightness is 0 % in the entire screen, the frame is fixed in the center.

# Acquiring Positioning Information by GPS **550**



## **SPC**

This camera recorder comes with a built-in GPS function. The GPS function is able to record the positioning information. During playback, you can also display the recorded information on the playback screen.





(P101 [Playing back])

### 1 Set [System] → [GPS] to “On”.

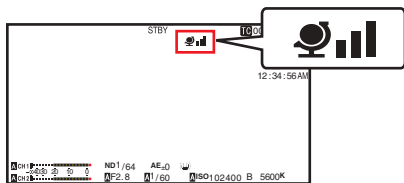
(P148 [GPS **550** **SPC**])

- Positioning starts when the  icon on the display screen starts blinking.
- After positioning is complete, the  icon switches to a solid light and records the positioning information during shooting.
- The icon that appears on the screen changes according to the condition of signal reception from the GPS satellite.



Display	Reception Status	Positioning Status
 (Yellow)	[GPS] is set to “On”, but signal cannot be received	GPS signal cannot be received. UTC and positioning information cannot be obtained.
 (Blink)	GPS search in progress	UTC information can be obtained, but not positioning information.
	GPS reception in progress (signal strength: weak)	Receiving weak GPS signal. UTC and positioning information can be obtained and recorded.
	GPS reception in progress (signal strength: medium)	Receiving GPS signal. UTC and positioning information can be obtained and recorded.

Display	Reception Status	Positioning Status
	GPS reception in progress (signal strength: strong)	Receiving strong GPS signal. UTC and positioning information can be obtained and recorded.
(No display)	GPS function is turned off	The [GPS] item is set to “Off”.

Memo :

- If positioning cannot be performed after waiting for several minutes, this means GPS reception is poor, and there is difficulty in receiving data. Move to an open place with no obstructions. Otherwise, GPS information will not be recorded when shooting is performed.
- Signal may not be received depending on circumstances such as locations that are indoors or surrounded by tall buildings, or the geographical conditions. Precision error may occur in the position information depending on the conditions of reception.
- Even when positioning is in progress, information may be disrupted depending on the condition of signal reception.
- When [A/V Set] → [Video Set] → [SDI OUT] → [Resolution] is set to “1080p”, configuring [System] → [GPS] to “On” changes the setting to “1080i”.

# Viewing Recorded Videos Immediately (Clip Review)

You can check (review) the last recorded video clip on the screen.

However, the video clip cannot be played back if the settings of the camera recorder are different from the video format (Resolution/Frame Rate/Bit Rate/SD Aspect) of the clip.

( P150 [A]Resolution/ [EXT]Resolution )

( P151 [A]Frame Rate/ [EXT]Frame Rate )

( P151 [A]Bit Rate/ [EXT]Bit Rate )

( P152 [ SD Aspect ] )

Memo : \_\_\_\_\_

- To use this function, assign “Clip Review” to any of the user buttons.

## 1 Press the user button assigned with the “Clip Review” function during standby (“STBY” is displayed).

Playback of the configured section starts.

Memo : \_\_\_\_\_

- The video clip is played back according to the setting in [Camera Function] → [User Switch Set] → [Clip Review]. By default setting (Last 5sec), the last 5 seconds of the clip is played back.  
( P116 [ Clip Review ] )
- When playback is complete, the camera recorder exits Clip Review and returns to “STBY” (recording standby) mode.

Caution : \_\_\_\_\_

- During Clip Review, only the [CANCEL] and [REC] buttons are enabled.  
Press the [CANCEL] button to cancel clip review and return to “STBY” (recording standby) mode.  
Press the [REC] button to cancel clip review and enter recording mode. It will take some time to start recording after the button is pressed.
- When the last clip is less than 5 seconds, the whole clip is played back.
- Only video clips in the currently selected slot can be reviewed.
- When there are no clips in the selected slot, Clip Review function is disabled.
- Clip Review is unavailable when Clip Continuous Rec is paused (“STBY<sup>C</sup>”, yellow text). To operate Clip Review, use the [CANCEL] button to set to “STBY<sup>G</sup>” (white text) first.  
( P92 [Clip Continuous Rec] )
- Clip Review is unavailable when the camera recorder is connected to an external equipment and the equipment is in recording state.
- Clip Review is unavailable when operating View Remote via network connection.  
( P196 [Camera Control Function] )
- Clip Review does not function during live streaming.
- Clip Review does not function while the record trigger is in the REC state.

# Displaying the Histogram

The histogram shows the brightness distribution, and is employed mainly for checking the exposure of the image.

## 1 Set the histogram feature to ON.

- Set [LCD/VF] → [Display Type] → [Histogram] to “On”.
  - You can also press the user button that is assigned with “Histogram”.
- (☞ P116 [User Switch Set Item])

## 2 Set the upper and lower limits of the histogram display.

After setting, the brightness level is displayed in red color.

Item	Settings	Options
Top	Sets the maximum brightness limit for changing the histogram display color	5% to 110% (in 5 % increments)
Bottom	Sets the minimum brightness limit for changing the histogram display color	0% to 105% (in 5 % increments)

■ When the upper limit is set to 110% and the lower limit to 0%



\* The area in red is not displayed.

■ When the upper limit is set to 90% and the lower limit to 10%



Bottom Top

### How to read the histogram

- The vertical axis denotes the number of pixels.
- The horizontal axis denotes the pixel brightness.

# Recording Simultaneously at Two Different Definitions

By setting [System] to “HD+Web”, you can record simultaneously at two different definitions.

- When HD+Web is selected:
  - Records a high-definition (HD) file to slot A and a web file to slot B at the same time.
  - Web files can be used as a proxy file for the HD file.

Memo : \_\_\_\_\_

- If a recordable SD card is inserted into only one of the slots, files will only be recorded to that slot.
- The [Rec Mode] is fixed at “Normal”.
- Clip Cutter Trig is disabled.
- [Slot Mode] cannot be selected.
- Clip Review can only be performed for slot A. (“No Media” appears if there is no card in slot A while a card is inserted into slot B.)
- Playback of web files is only possible from slot B when “HD+Web” is selected.

## Series Rec

- Series Rec mode is specified in the factory default. ([System] → [Record Set] → [Slot Mode] is set to “Series”.) (☞ P153 [ Slot Mode ] )
- If both the slots are loaded with recordable cards, pressing the [REC] button starts recording only to the media in the selected slot. When the remaining space in the selected media runs out, recording continues by automatically activating the media in the other slot.
- The slot mode can be identified on the status screen.

# Dual Rec

- If both the slots are loaded with recordable cards in the Dual Rec mode ([Slot Mode] is set to “Dual”), pressing the [REC] button starts recording simultaneously to the media in both the slots.
- The clips recorded to the media in both the slots are identical, and two clips of the same content can be created only on this camera recorder. (P153 [ Slot Mode ])

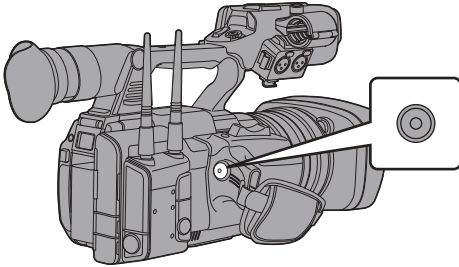

## Setting to Dual Rec Mode

- 1 Set [System] → [Record Set] → [Slot Mode] to “Dual”.**  
(P153 [ Slot Mode ])
- 2 Start recording.**
  - Insert recordable media in both slots, and press the [REC] button.
  - In the Dual Rec mode, recording to the media in both slots starts at the same time.
  - Both the card slot marks turn red, and the status indicators of both the card slots also light up in red.

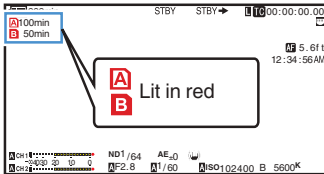

### 3 Stop recording.

- Press the [REC] button again.
- Recording to both slots stops, and both the card slot marks turn white.
- The same clips are recorded to both cards.

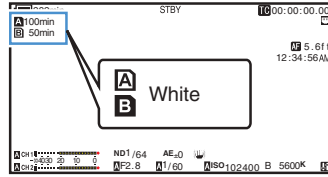

### Memo :

- During recording in the Dual Rec mode, both the card slot marks light up in red.
- During recording in the Dual Rec mode to two cards with a different amount of remaining space, if the space of one card runs out, recording to both slots will stop automatically. After recording stops, recording automatically resumes for the card with remaining space. Although the clips are separated in this case, the clips can be seamlessly joined by arranging them on the timeline of the editing software since they are recorded seamlessly.
- If the last clip on the cards that are inserted in the two slots are different from each other, and the time code operating mode is set to “Regen”, the Regen mode for the selected card slot will be enabled in the next recording.
- When [AFormat] is set to “High-Speed”, “Dual” cannot be selected.



Caution : \_\_\_\_\_

- To perform recording in the Dual Rec mode, it is recommended that you start recording by making use of two cards with the same capacity and from the formatted state.
- You can combine the use of the Dual Rec mode with a special recording mode. While in the Dual Rec mode, you can also set [Rec Mode] to “Normal”, “Pre Rec”, “Clip Continuous”, “Interval Rec”, or “Frame Rec”.

(☞ P91 [Special Recording] )

(☞ P153 [ Rec Mode ] )

- When both slots are inserted with recordable cards, the Dual Rec (simultaneous recording) operation can be performed. If a recordable media is only inserted in one of the slots, you can also start recording with one card.
- In the Dual Rec mode, continuous recording by switching from one slot to another cannot be performed. Continuous recording will not be performed if a recordable media is inserted in a slot after recording to the other slot has started.
- When recording to one slot is in progress with the recorder set to the Dual Rec mode, inserting a recordable media to the other slot does not enable the Dual Rec operation. To perform the Dual Rec operation, stop recording temporarily (excluding pausing recording in the Clip Continuous Rec mode), and start again.
- When one of the cards is accidentally removed while recording is in progress in the Dual Rec mode, recording to the card in the other slot will continue. However, repair of the accidentally removed card by the recovery function may fail.
- If an error occurs on one of the cards while recording is in progress in the Dual Rec mode, recording of the erroneous card stops, while that of the other card continues.
- Operations on clips recorded in the Dual Rec mode, such as clip deletion in the Media mode or appending of OK marks, can only be performed on the card in the selected slot.

## Backup Rec

- The Backup Rec mode allows you to make use of the media in slot B for backup recording by controlling the starting and stopping of recording in slot B without using the [REC] button.
- Start or stop the recording using [System] ➔ [Record Set] ➔ [Slot Mode] ➔ [Backup Rec] or press the user button that is assigned with “Backup Trig”.

(☞ P153 [ Slot Mode ] )

(☞ P116 [User Switch Set Item] )

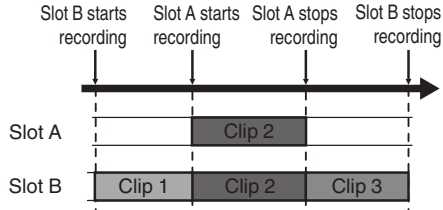

Memo : \_\_\_\_\_

- During the Backup Rec mode (when [Slot Mode] is set to “Backup”), you can control recording to the 2 slots at different timings, and backup recording can only be performed on this camera recorder.  
(☞ P153 [ Slot Mode ] )
- You can record without worrying about missing the important scenes by setting slot B to be always recording (backup recording) and using the [REC] button to start/stop recording of only the required scenes in slot A.
- It is recommended to use a media with high capacity in slot B.
- Backup cannot be selected when [A]Format is configured to “High-Speed”, “Exchange” (U model) or “MP4” (E model).

## 1 Set [System] → [Record Set] → [Slot Mode] to “Backup”.

(☞ P153 [ Slot Mode ] )

- The slot mode can be identified on the status screen.

## 2 Start backup recording. (Backup recording into slot B)

• Select “REC” in [System] → [Record Set] → [Slot Mode] → [Backup Rec] and press the Set button (●).

(☞ P153 [ Slot Mode ] )

- You can also press the user button that is assigned with “Backup Trig”.

(☞ P116 [ User Switch Set Item ] )

- Backup recording into slot B starts.
- The card slot mark of slot B turns red (selected state), and the status indicator of slot A blinks in red.

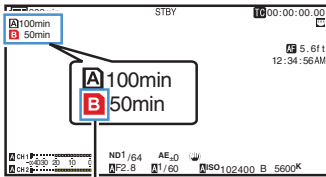

Red (selected)

## 3 Start normal recording (normal recording into slot A)

- Press any of the [REC] buttons.
- Recording into the media in slot A starts. (The characters “●REC” appear in red.)
- The card icon of slot A turns red (unselected state), and the status indicator of slot A blinks in red.

Red (not selected)

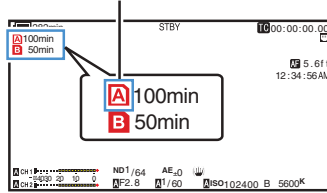

## 4 Stop normal recording.

- Press any of the [REC] buttons again.
- Recording to slot A stops, and the card slot mark of slot A turns white (unselected state).
- The characters “●REC” (red) changes back to “STBY” (white).
- The status indicator of slot A goes out.

White (not selected)

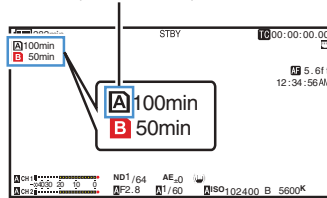

## 5 Stop backup recording.

- Select [STBY] in [System] → [Record Set] → [Slot Mode] → [Backup Rec] and press the Set button (●).
- (☞ P153 [ Slot Mode ])
- You can also press the user button that is assigned with “Backup Trig”.
- (☞ P116 [User Switch Set Item ])
- Recording to slot B stops, and the card slot mark of slot B turns white (unselected state).
- The status indicator of slot B lights up in green.

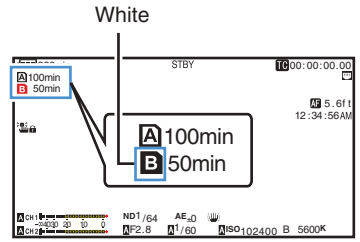

Memo : \_\_\_\_\_

- During backup recording, if the space of one card runs out, recording stops only for the card that is full.
- When recording to both slots is stopped, recording in the Regen mode will be enabled for the card slot in which recording started.
- When recording is started in the other slot while recording to one slot, the clip being recorded is split and simultaneous recording to the other card starts.
- When recording is stopped for either slot A or B while recording to both slots, the clip on the slot which is still recording is split.
- Although the clips are separated during recording the clips can be seamlessly joined by arranging them on the timeline of the editing software since they are recorded seamlessly.
- Clip Cutter Trig cannot be performed during backup recording.
- (☞ P96 [Splitting the Clips Freely (Clip Cutter Trig)])
- When [Slot Mode] is set to “Backup”, [Rec Mode] can only be set to “Normal”.
- (☞ P153 [ Rec Mode ])

# Special Recording

Besides the normal recording mode, four special recording methods are available in this camera recorder. They are Pre Rec, Clip Continuous, Frame Rec and Interval Rec. Select a mode from [System] → [Record Set] → [Rec Mode].

(☞ P153 [ Rec Mode ])

Memo : \_\_\_\_\_

- Special recording cannot be selected when [System] → [Record Set] → [Record Format] → [System] is set to “4K EXT (SSD)”, “HD+Web” or “High-Speed”.

## Pre Rec

- By setting the number of seconds in the [Pre Rec Time], you can start recording video and audio before actual recording starts based on the [Pre Rec Time] setting.
- When starting actual recording while the camera recorder is in Recording Standby (STBY) mode, you can start recording a few seconds earlier based on the [Pre Rec Time] setting.
- Using Pre Rec allows you to record a complete event without missing the initial scenes even if you start the recording late.

Memo : \_\_\_\_\_

- Pre Rec Time can be set in [System] → [Record Set] → [Rec Mode] → [Pre Rec Time].
  - When [System] is set to “4K”: Fixed at “5sec”
  - When [System] is set to “HD” or “SD”: “5sec”, “10sec” or “15sec”
- (☞ P153 [ Pre Rec Time ])

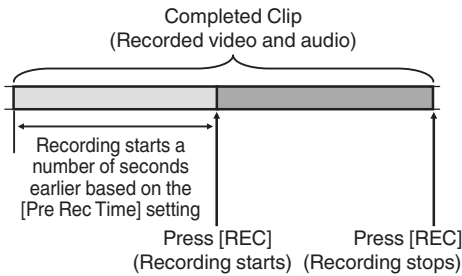

## 1 Set [Rec Mode] to "Pre Rec".

(☞ P153 [ Rec Mode ] )

- Set [System] → [Record Set] → [Rec Mode] to "Pre Rec".
- The display changes ("STBY" → "STBY $\square$ ").

## 2 Press the [REC] button to start recording in Pre Rec mode.

- The display changes ("STBY $\square$ " → "●REC $\square$ ") and the card slot status indicator lights up in red.
- Press the [REC] button again to pause recording. The display changes ("●REC $\square$ " → "STBY $\square$ ") and the card slot status indicator lights up in green.

### Caution :

- When the interval between start and stop recording is short, "STBY $\square$ " may not be displayed immediately after recording is complete. "●REC $\square$ " → "STBY $\square$ " ("STBY" blinks in red) → "STBY $\square$ " is displayed.
- When the SD card becomes full during recording, recording stops and "STOP" is displayed.
- In the following cases, video and audio before the specified Pre Rec time may not be recorded even if recording starts.
  - Immediately after power on
  - Immediately after recording stops
  - Immediately after switching from Media mode to Camera mode
  - Immediately after setting [Rec Mode]
  - Immediately after the end of Clip Review
  - Immediately after changing file format
  - Immediately after changing video format

## Clip Continuous Rec

- In normal recording, when the recording stops, the image, audio, and accompanying data from the start till the end of the recording are recorded as one "clip" on the SD card.
- This mode allows you to consolidate several rounds of "startstop recording" into one clip.

### Example:

In normal recording, three clips are generated as Recording 1, Recording 2, and Recording 3. However, recording in this mode generates only one clip.

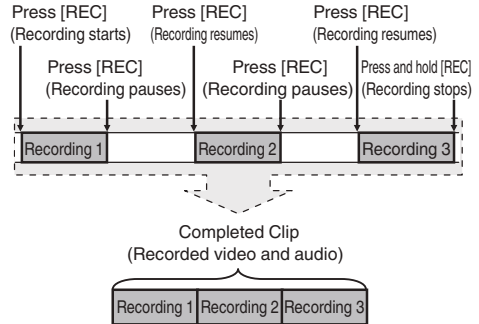

## 1 Set "Rec Mode" to "Clip Continuous".

(☞ P153 [ Rec Mode ] )

- Set [System] → [Record Set] → [Rec Mode] to "Clip Continuous".
- The display changes ("STBY" → "STBY $\square$ ").

## 2 Start recording. (Recording 1)

- Press the [REC] button to start recording in Clip Continuous mode.
- The display changes ("STBY $\square$ " → "●REC $\square$ ") and the card slot status indicator lights up in red.

**3 Pause recording.**

- Press the [REC] button again to pause recording. The display changes (“●REC” → “STBY”) (yellow text).
- The card slot status indicator remains lighted in red.

Memo : \_\_\_\_\_

- When the [CANCEL] button is pressed while the camera recorder is paused (STBY), the display changes (“STBY”) (yellow text) → “STBY” (blinking yellow text) → “STBY” (white text)), and a “clip” is generated. The card slot status indicator lights up in green.

**4 Resume recording. (Recording 2)**

- Press the [REC] button again to resume recording. The display changes (“STBY”) (yellow text) → “●REC”.
- The card slot status indicator remains lighted in red.

**5 Pause recording.**

- Press the [REC] button again to pause recording. The display changes (“●REC” → “STBY”) (yellow text).
- The card slot status indicator remains lighted in red.

**6 Resume recording. (Recording 3)**

- Press the [REC] button again to resume recording. The display changes (“STBY”) (yellow text) → “●REC”.
- The card slot status indicator remains lighted in red.

**7 Press and hold the [REC] button.**

- Recording stops and the display changes (“●REC” → “STBY”). A “clip” is generated.
- The card slot status indicator lights up in green.

**8 Press the [REC] button again.**

- The display changes (“STBY” → “●REC”) and the card slot status indicator lights up in red.
- A new “clip” is generated from here.

Memo : \_\_\_\_\_

- The following operations cannot be performed while recording is paused (STBY, yellow text).
  - Clip Review operation (P86 [Viewing Recorded Videos Immediately (Clip Review)])
  - Switching SD card slots
  - Switching operation mode (P24 [Operation Modes])
- Files are split into sizes of 4 GB (or 30 minutes) regardless of the menu settings.

Caution : \_\_\_\_\_

- Do not remove the SD card during recording (●REC, red text) or recording pause (STBY, yellow text).
- To remove the SD card in the “Clip Continuous” mode, press the [CANCEL] button, check that “STBY” (white text) is displayed and the card slot status indicator lights up in green before you remove the card.
- To remove the SD card in the “Clip Continuous” mode, press the [CANCEL] button, check that “STBY” (white text) is displayed and the card slot status indicator lights up in green before you remove the card.
- When the SD card becomes full during recording, recording stops and “STOP” is displayed.
- When the [POWER ON/OFF] switch is turned off during recording or recording pause, recording stops and power is cut off after a clip is generated.
- If the power is cut off due to low battery power, a proper clip may not be generated.

## Frame Rec

In normal recording, when the recording stops, the image and accompanying data from the start till the end of the recording are recorded as one “clip” on the SD card.

In this mode, recording starts with every press of the [REC] button, and only the specified number of frames is recorded.

The recording can be written to the media as a single clip until it is stopped.

Memo : \_\_\_\_\_

- Audio will not be recorded.
- Until a specified amount of recordings is accumulated, the file cannot be written to the media.
- If the specified amount is not reached when recording is stopped, normal recording is performed and frames are added to the ending of the clip until the amount is reached. (Padding)
- After the specified number of frames is recorded and written to the media, recording will be performed until the same number is accumulated again.

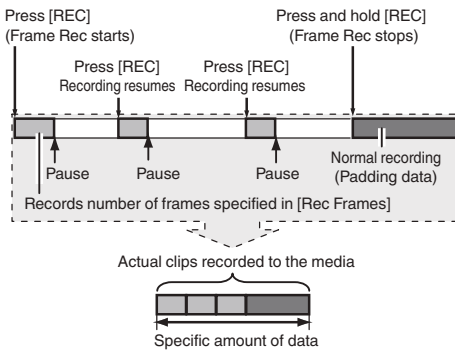

### 1 Set [Rec Mode] to “Frame Rec”.

- Set [System] → [Record Set] → [Rec Mode] to “Frame Rec”.
- (☞ P153 [ Rec Mode ])
- The display changes (“STBY” → “STBY $\overline{\text{F}}$ ”).

### 2 Set the number of frames to record in [Rec Frames].

- To configure the setting, go to [System] → [Record Set] → [Rec Mode] → [Rec Frames].
- (☞ P153 [ Rec Frames ])

### 3 Start recording.

- Press the [REC] button to record only the number of frames specified in [Rec Frames] and pause.
- The display changes (“STBY $\overline{\text{F}}$ ” → “●REC $\overline{\text{F}}$ ” → “STBY $\overline{\text{F}}$ ” (yellow text)).
- The card slot status indicator lights up in green.

### 4 Repeat Frame Rec.

- Press the [REC] button again to record only the number of frames specified in [Rec Frames] and pause.
- The display changes (“STBY $\overline{\text{F}}$ ” → “●REC $\overline{\text{F}}$ ” → “STBY $\overline{\text{F}}$ ” (yellow text)).
- Frame Rec continues until the recording is stopped (step 5).

### 5 Press and hold the [REC] button.

- The card slot status indicator lights up in green.

Caution : \_\_\_\_\_

- Do not remove the SD card during recording (“●REC $\overline{\text{F}}$ ”, red text) or recording pause (“STBY $\overline{\text{F}}$ ”, yellow text).
- To remove the SD card during Frame Rec, press the [CANCEL] button, check that “STBY $\overline{\text{F}}$ ” (white text) is displayed and the card slot status indicator lights up in green before you remove the card.
- When [TC/UB] → [TC Generator] is set to “Free Run” or “Free Run(Ext)”, the time code will be recorded in “Rec Run”.
- Audio cannot be recorded. The audio level meter is grayed out.
- (☞ P160 [Audio Level Meter])

## Interval Rec

In normal recording, when the recording stops, the image and accompanying data from the start till the end of the recording are recorded as one “clip” on the SD card.

In this mode, recording and pause are performed repeatedly at the specified time interval. Only the specified number of frames is recorded. The recording can be written to the media as a single clip until it is stopped.

Memo : \_\_\_\_\_

- Audio will not be recorded.
- Until a specified amount of recordings is accumulated, the file will not be written to the media.
- After the specified number of frames is recorded and written to the media, recording will be performed until the same number is accumulated again.
- If the specified amount is not reached when recording is stopped, normal recording is performed and frames are added to the ending of the clip until the amount is reached. (Padding)

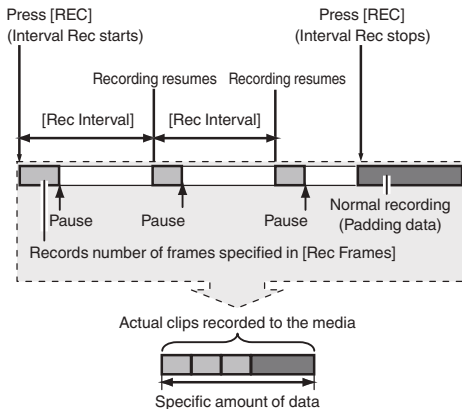

### 1 Set [Rec Mode] to “Interval Rec”.

- Set [System] → [Record Set] → [Rec Mode] to “Interval Rec”.
- (☞ P153 [ Rec Mode ])
- The display changes (“STBY” → “STBY $\blacksquare$ ”).

### 2 Set the number of frames to record in [Rec Frames].

To configure the setting, go to [System] → [Record Set] → [Rec Mode] → [Rec Frames].  
(☞ P153 [ Rec Frames ])

### 3 Set the time interval to start recording in [Interval Rec].

To configure the setting, go to [System] → [Record Set] → [Rec Mode] → [Rec Interval].  
(☞ P153 [ Rec Interval ])

### 4 Start recording.

- Press the [REC] button to record only the number of frames specified in [Rec Frames] and pause.
- After the specified time in [Rec Interval] has passed, recording starts again to record only the number of frames specified in [Rec Frames] and pause.
- Interval Rec continues until the recording is stopped.  
The display changes (“STBY $\blacksquare$ ” → “●REC $\blacksquare$ ” → “STBY $\blacksquare$ ” (red text) → “●REC $\blacksquare$ ” → “STBY $\blacksquare$ ” (red text)).
- The card slot status indicator lights up in red.

### 5 Press the [REC] button.

- The card slot status indicator lights up in green.
- The display becomes “STBY $\blacksquare$ ”.

Caution : \_\_\_\_\_

- Do not remove the SD card during recording (●REC $\blacksquare$ , red text) or recording pause (STBY $\blacksquare$ , yellow text).
- To remove the SD card during Interval Rec, press the [CANCEL] button, check that “STBY $\blacksquare$ ” (white text) is displayed and the card slot status indicator lights up in green before you remove the card.
- When [TC/UB] → [TC Generator] is set to “Free Run” or “Free Run(Ext)”, the time code will be recorded in “Rec Run”.
- Audio cannot be recorded. The audio level meter is grayed out.  
(☞ P160 [Audio Level Meter])

# Splitting the Clips Freely (Clip Cutter Trig)

You can split the clips freely without having to stop recording during shooting.

- 1 **Assign the “Clip Cutter Trig” function to any of the user buttons.**  
(☞ P46 [Assignment of Functions to User Buttons] )
- 2 **Press the user button that is assigned with “Clip Cutter Trig” during shooting.**  
A clip cut icon (●✂) appears on the display screen for 3 seconds, and the clip is split.

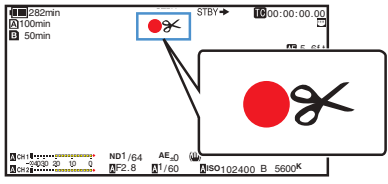

- Memo : \_\_\_\_\_
- Clips cannot be split again for a few seconds after the operation is performed.
  - This item cannot be used when [Slot Mode] is set to “Backup”.
  - This item cannot be used when [Rec Mode] is set to a value other than “Normal” or “Pre Rec”. (☞ P153 [ Rec Mode ] )
  - The split clips are recorded seamlessly without interruptions in the video.
  - When “4K EXT (SSD)”, Exchange (U model) or MP4 (E model) is selected, the clip cutter function cannot be used.

# Configuring Infrared Recording

This camera recorder comes with an infrared recording mode that is suitable for night recording. Using infrared illumination allows images to be captured naturally in a pitch-dark environment. It is recommended for observation of animals without alerting them or for natural facial expressions without firing glaring flash light at the subject.

- 1 **Set the [FULL AUTO] switch to “OFF”.**
- 2 **Set [Camera Function] ➔ [Infrared] to “On”.**  
A “☞” icon appears.

Caution : \_\_\_\_\_

- Do not use infrared recording for capturing strong light sources or heat sources. Doing so may damage the camera recorder.

- Memo : \_\_\_\_\_
- The settings are fixed as followed when it is configured to “On”.
    - Manual focus
    - ND Filter “OFF”
    - [Camera Function] ➔ [Focus] ➔ [AF Assist] and [MF Assist] appear as “---”.
    - All items other than [Color Space] and [Reverse Picture] under [Camera Process] appear as “---”.
  - The zoom and focus positions will be initialized after the settings are changed.
  - When [Infrared] is configured to “On”, if the type of light source changes after focus is established, the image may go out of focus.



# Playing Recorded Clips

To play back clips recorded in a recording media, switch to the Media mode. Press and hold the [MODE] selection button in the Camera mode to enter the Media mode. A thumbnail screen of the clips recorded on the recording media is displayed. You can play back the selected clip on the thumbnail screen.

Memo : \_\_\_\_\_

- When a recording media without any clips is inserted, "No Clips" is displayed.

## Operation Buttons

Use the operation buttons on the side control panel or front side of the camera recorder to operate the thumbnail screen.

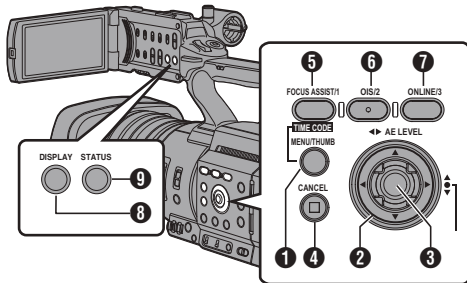

- [MENU/THUMB] Button**
  - Displays the menu.
  - Press this button to close the menu screen during menu display and return to the thumbnail screen.
- Cross-Shaped Button (▲▼◀▶)**

Moves the cursor.
- Set (Play) Button**
  - Sets the values and items. (Confirm)
  - Plays back the selected clip.
- [CANCEL] (Stop) Button**

Cancels settings and returns to the previous screen.
- [FOCUS ASSIST/1] Button**
  - Switches the OK mark of the clip selected by the cursor.
  - If an OK mark has been appended, it will be deleted. Otherwise, an OK mark will be appended.

- [OIS/2] Button**
  - Switches the selection status of the clip selected by the cursor.
  - Clips being selected are displayed with check mark.
- [ONLINE/3] Button**

Enters the action selection screen.
- [DISPLAY] Button**

Switches between the "Standard Screen" and "Detailed Screen".
- [STATUS] Button**

Displays the media information screen.

## Thumbnail Screen

- "Standard Screen" and "Detailed Screen" are available. Use the [DISPLAY] button to switch between the screens.
- Thumbnails are displayed in order of recording from the oldest to most recent.

### Standard screen



- Recording Media Information**
    - Displays the status when repair is required for the selected recording media or the status of the write-protect switch for the SD card.
    - The inserted recording media will not be displayed if [System] is different.
    - Use the [SLOT SEL] button to switch between slots A and B. Clips from different slots cannot be displayed at the same time.
- A** : Write-protect switch of the SD card in slot A is set.
- B** : SD card in slot B needs to be restored or formatted, or is an unsupported SD card.
- EXT** : SSD media in [EXT.SLOT]

- 2** Clip Mark  
Displays the clip information (properties).



**1** OK Mark

Clip is appended with OK mark.

Memo : \_\_\_\_\_

- Clips appended with OK marks cannot be deleted on the camera recorder.

**2** Continued From Mark

This mark indicates that the current clip is continued from another SD card when recording is divided and made on several SD cards.

**3** Uneditable Mark

- This mark indicates that an OK mark cannot be appended to or deleted from the clip, and the clip cannot be deleted.

**4** Continue Mark

This mark indicates that recording of the current clip is continued to another SD card when recording is divided and made on several SD cards.

**5** Check Mark

- A green check mark is displayed when the clip is selected.
- Magenta and gray check marks are displayed in multiple selection mode.

(☞ P104 [Selecting and Performing Operations on Multiple Clips])

**3** Cursor

Clip to be worked on. Use the cross-shaped button (▲▼◀▶) to move the cursor.

**4** Thumbnail Substitution Display



- 1** A clip with corrupted management information. It cannot be played back even if you press the Set (Play) button.

- 2** A clip that cannot be played back nor displayed in thumbnail with the current video format settings. It cannot be played back even if you press the Set (Play) button.

Memo : \_\_\_\_\_

- This is dependent on the [System], [Format], [Resolution], [Frame Rate] and [Bit Rate] settings in the [System] → Record Set → [Record Format] menu.  
(☞ P149 [ System ])

**5** Clip Name

The file name (clip number) of the selected clip is displayed.

**6** Operation Guide

- Displays a guide for the current operation buttons.
- The action selection screen is displayed when the [ONLINE/3] button is pressed.  
(☞ P99 [Actions])

**7** Recording Start Time

Displays the recording start time of the clip.

Memo : \_\_\_\_\_

- The date/time display is dependent on the settings in [System] → [Date Style]/[Time Style].  
(☞ P148 [ Date Style ] )  
(☞ P149 [ Time Style ] )

**8** Scroll Bar

- Indicates the scroll position.
- Black space below the scroll bar (white) indicates that there are more pages.
- When the scroll bar (white) is at the bottom, this indicates the last page.

**9** Remaining Battery Power

(☞ P37 [Power Status Display])

**10** Number of Clips

- If none of the clips are selected, the “running number/total number of clips” of the clip to be displayed appears.
- Even if only one clip is selected, the number of selected clips in the current slot is displayed.

**11** Network Connection Icon

- The network connection status is displayed.

## Detailed screen

\* Items that are common with the Standard screen will not be described. Refer to “[Standard screen] (P 97)”.

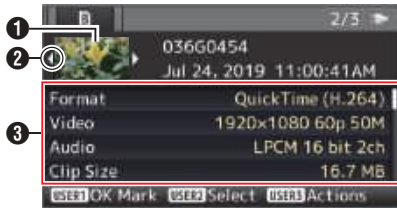

- 1 **Thumbnail**  
Thumbnail of the clip selected by the cursor. Use the cross-shaped button (◀▶) to move the cursor.
- 2 **Scroll Mark (<>)**
  - If there are previous clips, < appears on the left.
  - If there are more clips, > appears on the right.
  - The marks will not be displayed if there are no clips before and after the current clip.
- 3 **Metadata**  
Metadata of the clip pointed by the cursor. You can use the cross-shaped button (▲▼) to scroll.

## Actions

The action selection screen is displayed when the [ONLINE/3] button is pressed.

The following operations can be performed.

Item	Description
Select All Clips	Selects all clips.
Select OK Marked	Selects all clips appended with OK mark.
Select Range	Specifies the range when selecting multiple clips. (P104 [Selecting Multiple Clips Randomly])
Deselect All	Clears all clip selections.
Add OK Mark	Appends an OK mark. <ul style="list-style-type: none"> <li>• This Clip: Appends an OK mark to the clip pointed by the cursor.</li> <li>• Selected Clips: Appends an OK mark to the clips selected (appended with check mark).</li> <li>• All Clips: Appends an OK mark to all clips.</li> </ul>
Delete OK Mark	Deletes the OK mark. <ul style="list-style-type: none"> <li>• This Clip: Deletes the OK mark of the clip pointed by the cursor.</li> <li>• Selected Clips: Deletes the OK mark of the clips selected (appended with check mark).</li> <li>• All Clips: Deletes the OK mark of all clips.</li> </ul>

Item	Description
FTP Upload	Uploads a clip to the FTP server. <ul style="list-style-type: none"> <li>• This Clip: Uploads the clip pointed by the cursor.</li> <li>• Selected Clips: Uploads the clips selected (appended with check mark).</li> <li>• All Clips: Uploads all clips.</li> </ul>
Delete Clips	Deletes clip. However, clips with OK mark cannot be deleted. <ul style="list-style-type: none"> <li>• This Clip: Deletes the clip pointed by the cursor.</li> <li>• Selected Clips: Deletes the clips selected (appended with check mark).</li> <li>• All Clips: Deletes all clips.</li> </ul>
Trim This Clip	Trims the clip pointed by the cursor.

Memo :

- The object of action is the clip of the current slot being displayed.
- [Selected Clips] cannot be performed if there are no selected (appended with check mark) clips.
- [This Clip] cannot be performed if there are more than one selected (appended with check mark) clips.
- If the write-protect switch of an SD card is set, OK mark cannot be appended or deleted, and the clips cannot be deleted and trimmed.

## Playing back

Use the operation buttons on the side control panel of the camera recorder to play back.

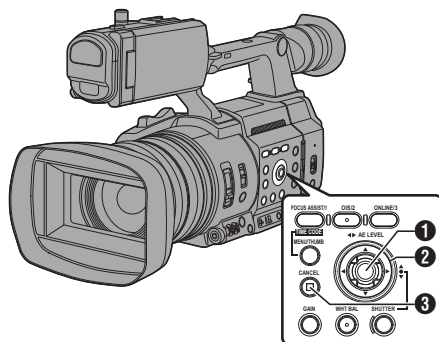

### 1 Set Button (●)

- Plays back/pauses the clip pointed by the cursor.
- You can press the cross-shaped button (◀▶) to perform frame-by-frame forward playback during pause mode.

### 2 Cross-shaped Button (▲▼◀▶)

- [▲/▼] Button: Skips in the reverse or forward direction.
- [◀/▶] Button:
  - During Playback: Fast forwards in the reverse or forward direction.
  - While paused: Frame-by-frame playback in the reverse or forward direction.

### 3 [CANCEL] Button

Stops playback.

### 1 In the thumbnail screen, move the cursor to the clip to be played back.

Move the cursor to the clip to be played back using the cross-shaped button (▲▼◀▶).

### 2 Press the Set button (●).

Playback of the selected clip starts.

## Audio Output during Playback

- You can confirm the playback sound from the monitor speaker, or the headphone connected to the [ ] terminal. When a headphone is connected to the [ ] terminal, sound cannot be output from the monitor speaker. (P176 [Connect the headphone.] )
- Adjust the volume of the monitor speaker and headphone using the [MONITOR +/-] volume adjustment button on the LCD monitor section of the camera recorder.

## Time Code Playback

Time code or user's bit recorded on an SD card can be displayed on the LCD monitor and viewfinder.

Memo : \_\_\_\_\_

- The time code is also superimposed on the video signal output from the [SDI OUT] terminal.
- If a section without time code is played back, the time code will stop. However, playback will continue.

## Displaying Information during Shooting

During playback, pressing the [DISPLAY] button shows the display screen. Pressing the [ONLINE/3] button during shooting switches the display information between camera information display, GPS display and turning off the display.

- The GPS display displays information on the recording location of the video being played back only when GPS information has been recorded.
- Camera information display displays only information of Gain, Iris, Shutter and White Balance that have been recorded.

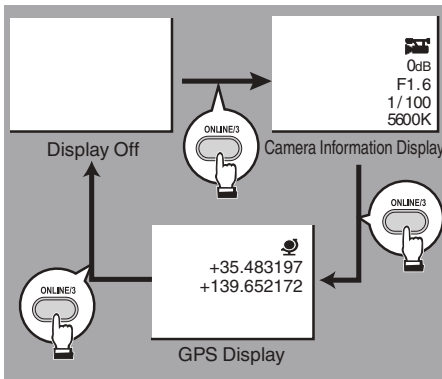

Memo : \_\_\_\_\_

- Trimming information is displayed while trimming is in progress. In this case, pressing the [ONLINE/3] button does not switch the display.

# Deleting Clips

Delete clip.

Memo : \_\_\_\_\_

- Clips appended with OK marks cannot be deleted on the camera recorder.
- Read-only clips can be deleted on a PC.

## Deleting One Clip

Delete the clip (one clip) pointed by the cursor in [Delete Clips] → [This Clip] in the menu.

Memo : \_\_\_\_\_

- Clips with OK mark cannot be deleted.

### During Thumbnail Screen

- 1 Move the cursor to the clip to be deleted.**  
Move the cursor to the clip to be deleted using the cross-shaped button (▲▼◀▶).

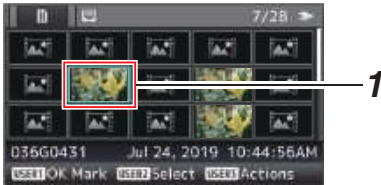

- 2 Press the [ONLINE/3] button.**  
The action selection screen is displayed.
- 3 Select [Delete Clips] → [This Clip] and press the Set button (●).**  
A screen to confirm deletion appears.

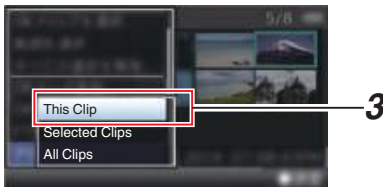

- 4 Select [Delete] using the cross-shaped button (▲▼), and press the Set button (●).**  
Deleting starts.

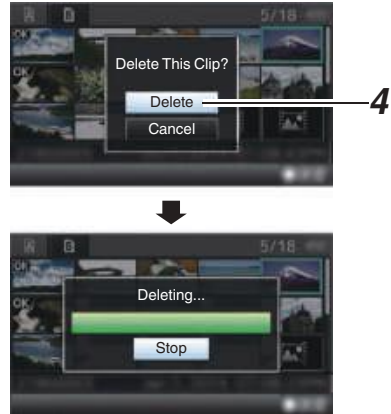

## Selecting and Deleting Multiple Clips

To select and delete multiple clips, refer to "[Selecting and Performing Operations on Multiple Clips] (P 104)".

## Deleting All Clips

Delete all clips that are displayed.

- 1 Press the [ONLINE/3] button.**  
The action selection screen is displayed.
- 2 Select [Delete Clips] → [All Clips].**  
A screen to confirm deletion appears.
- 3 Select [Delete] and press the Set button (●).**  
Deleting starts.

Memo : \_\_\_\_\_

- The time taken to delete clips depends on the number of clips to be deleted.

# Appending/Deleting OK Mark

- You can append OK marks to the clips for important scenes.
- Clips appended with OK marks cannot be deleted, thus protecting the important clips.
- When the camera recorder is in Media mode, you can delete the OK marks appended during recording, or append/delete OK marks after shooting.

## During Thumbnail Screen

- 1 Press the [FOCUS ASSIST/1] button.
  - If the clip does not have an OK mark, an OK mark will be appended.
  - If the clip is appended with an OK mark, the OK mark will be deleted.

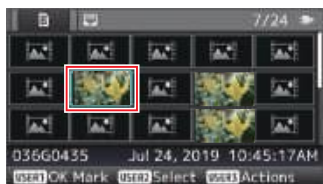

## During Playback or Pause Screen

- 1 Press [FOCUS ASSIST/1] button during clip playback.
  - If the clip does not have an OK mark, an OK mark will be appended.
  - If the clip is appended with an OK mark, the OK mark will be deleted.



Memo : \_\_\_\_\_

- The clip pauses when an OK mark is appended or deleted during playback.

## Appending/Deleting OK Mark of Multiple Clips

To select and append/delete OK mark for multiple clips, refer to “[Selecting and Performing Operations on Multiple Clips] (P 104)”.

# Selecting and Performing Operations on Multiple Clips

- Multiple clips can be selected during thumbnail screen or playback screen display.
- After selecting multiple clips, perform appending/deleting of OK mark, deleting of clips using the action selection screen.
- After selecting multiple clips, the selections will be canceled by the following operations.
  - When [Deselect All] in the action menu is selected
  - When exiting Media mode from the thumbnail screen
  - When the recording media is removed
  - When switching the slot in use

## Selecting Multiple Clips Randomly

- 1 Move the cursor to a clip without a check mark, and press the [[OIS/2] button.

A green check mark appears on the clip.



- 2 Repeat Step 1 to select multiple clips.

- Multiple clips can be selected.
- Press the [ONLINE/3] button while the multiple clips are selected.
  - Appends OK mark together:  
[Add OK Mark] → [Selected Clips]
  - Deletes OK mark together:  
[Delete OK Mark] → [Selected Clips]
  - Uploading selected clips to the FTP server together:  
[FTP Upload] → [Selected Clips]
  - Deletes selected clips together:  
[Delete Clips] → [Selected Clips]

Memo : \_\_\_\_\_

- Selecting clips appended with check mark and pressing the [OIS/2] button will cancel the selection.
- If the operation is performed on multiple clips at the same time, a progress bar appears. You can stop the operation by pressing the Set button (●) while the operation is in progress. However, it is not possible to undo operations that are completed.



## Selecting Multiple Clips Consecutively

- 1 Press the [ONLINE/3] button.
- 2 Select “Select Range” in the action selection screen, and press the Set button (●).

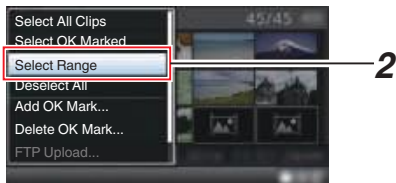

- 3 Move the cursor to the beginning (or end) of the range for multiple selection, and press the Set button (●).
- 4 Move the cursor to the other end of the range.
  - Magenta check marks appear on the clips within the range. (Including clips that were already selected.)
  - Gray check marks appear on selected clips that are outside the range.

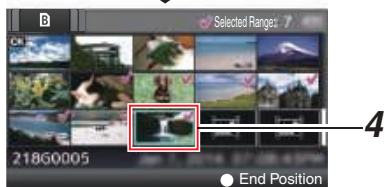
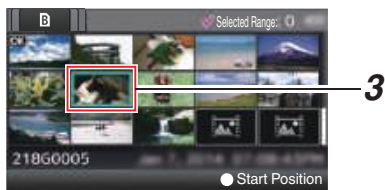

- 5 Press the Set button (●) to confirm the range.
  - The check marks change from magenta to green.
  - Pressing the [ONLINE/3] button while the multiple clips are selected displays the action selection screen. The following operations can be performed.
    - Appends OK mark together:  
[Add OK Mark] → [Selected Clips]
    - Deletes OK mark together:  
[Delete OK Mark] → [Selected Clips]
    - Uploading selected clips to the FTP server together:  
[FTP Upload] → [Selected Clips]
    - Deletes selected clips together:  
[Delete Clips] → [Selected Clips]

Memo : \_\_\_\_\_

- Selecting clips appended with check mark and pressing the [[OIS/2] button will cancel the selection.
- If the operation is performed on multiple clips at the same time, a progress bar appears. You can stop the operation by pressing the Set button (●) while the operation is in progress. However, it is not possible to undo operations that are completed.

# Trimming Recorded Clips

It is possible to crop (trim) the necessary parts of a clip that is recorded to the recording media. The trimmed clip is saved as a separate file to the recording media and the original clip remains intact.

## 1 Switch to Media mode.

Switch the mode using the [MODE] selection button on the side operation panel.

## 2 Move the cursor to the clip to be trimmed.

Move the cursor to the clip to be trimmed using the cross-shaped button (▲▼◀▶).

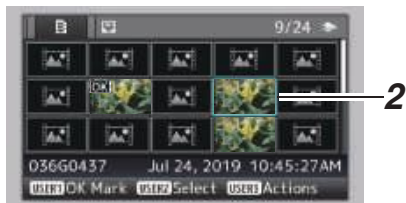

## 3 Press the [ONLINE/3] button.

The action selection screen is displayed.

## 4 Select [Trim This Clip], and press the Set button (●).

Playback of the selected clip starts.

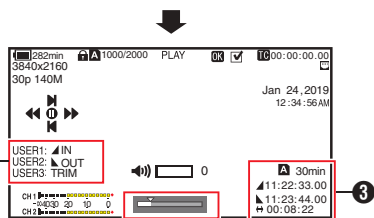
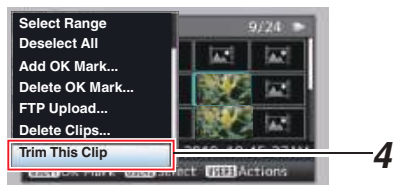

## 1 Guide

Operation guide

## 2 Position bar

- ▼ : Current position of the video
- ▲ : Position to start trimming (in point)
- ▶ : Position to end trimming (out point)

## 3 Trimming information

- Ⓐ or Ⓑ : Indicates the available space in the storage media (Ⓐ or Ⓑ)
- ▲ : Indicates the time code of the in point
- ▶ : Indicates the time code of the out point
- ↔ : Indicates the duration from the in point to the out point

Memo : \_\_\_\_\_

- The trimmed clip will be saved to the same card slot as that of the original clip.
- [Duration] appears in yellow if the duration is 10 minutes or longer. Trimming cannot be performed in this case.
- When [System] → [Record Set] → [Record Format] → [Frame Rate] is set to "4:2:2 10 70M (XHQ)", [Duration] appears in yellow if the duration is 6 minutes or longer. Trimming cannot be performed in this case.
- When [System] → [Record Set] → [Record Format] → [System] is configured to "4K EXT (SSD)" or "4K", [Duration] appears in yellow if it is 3 minutes or longer. Trimming cannot be performed in this case.
- [Duration] appears in yellow if the duration is longer than the recordable time on the storage media. Trimming cannot be performed in this case.
- When trimming starts, the display switches to the Media Display screen.

## 5 Specify the in point.

- Operate buttons such as ◀▶ or ▲▼ to move the video to the in point.  
(P100 [Playing back] )
- Specify the in point by pressing the [FOCUS ASSIST/1] button at the point you want to start trimming.

## 6 Specify the out point.

- Operate buttons such as ◀▶ or ▲▼ to move the video to the out point.  
(P100 [Playing back] )
- Specify the out point by pressing the [OIS/2] button at the point you want to end trimming.

## 7 Perform trimming.

Press the [ONLINE/3] button to perform trimming.

Memo : \_\_\_\_\_

- While trimming is in progress, you can press the [CANCEL] button to return to the thumbnail screen.
- When trimming the in and out point, the in point trimmed may be up to one second before the specified in point and the out point trimmed may be up to one second behind the specified out point.

# Basic Operations in Menu Screen

- Pressing the [MENU/THUMB] button displays the menu screen on the LCD monitor and viewfinder.
- Various settings for shooting and playback can be configured on the menu screen.
- There are two types of menu screens - [Main Menu] and [Favorites Menu].
- [Main Menu] contains all the setting items of the camera recorder, classified according to functions and uses, while [Favorites Menu] allows users to customize the menu items freely. (P155 [Adding/Editing Frequently Used Menu Items (Favorites Menu)])
- The operating procedures and main screen displays are the same for both menus.
- The menu screen can also be displayed on external monitors connected to the [SDI OUT] terminal.  
(P130 [Character])

## Operation Buttons

To operate the menu, use the cross-shaped buttons on the side operation panel of the camera recorder or the cross-shaped buttons at the front of the camera or at the bottom of the lens.

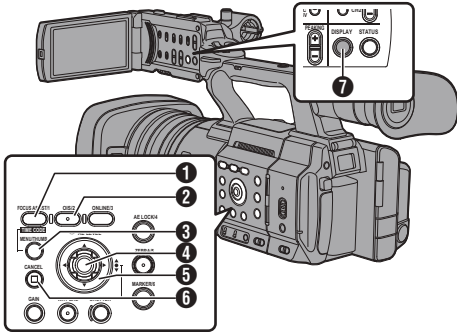

- 1 [FOCUS ASSIST/1] Button  
Adds the selected menu or submenu item to the [Favorites Menu].
- 2 [OIS/2] Button  
Resets settings in the [TC Preset] or [UB Preset] setting screen.
- 3 [MENU/THUMB] Button
  - Displays the menu screen. The [Main Menu] screen is displayed by default.
  - During normal usage, [Main Menu] is displayed if the previous menu operation ended at [Main Menu], and [Favorites Menu] if the previous menu operation ended at [Favorites Menu].
  - Press this button to close the menu screen during menu display and return to the normal screen.
  - Pressing and holding down the button while the menu is displayed switches the [Main Menu] screen to the [Favorites Menu] or vice versa.
- 4 Set Button (●)  
Sets the values and items.
- 5 Cross-shaped Button (▲▼◀▶)
  - ▲ : Moves the cursor upward.
  - ▼ : Moves the cursor downward.
  - ◀ : Moves back to the previous item.
  - ▶ : Moves forward to the next item.
- 6 [CANCEL] Button  
Cancels settings and returns to the previous screen.
- 7 [DISPLAY] Button  
Switches between the [Main Menu] and [Favorites Menu] screens.

## Display and Description of the Menu Screen

### Selecting Menu Items

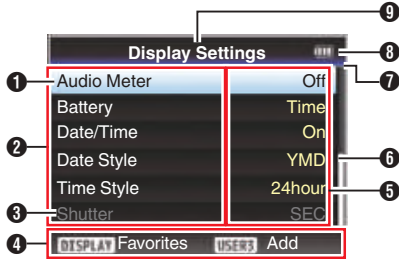

- 1 Cursor  
Indicates the selected item. Use the cross-shaped button (▲▼) to move the cursor
- 2 Menu Item
  - Displays the names of the menu item and sub-menu.
  - Menu items with [...] after them indicates that there is a sub-menu to access.
- 3 Fixed Item  
Items that cannot be changed are displayed in gray and cannot be selected.
- 4 Operation Guide  
Guide for the current operation buttons.
- 5 Setting Value  
Setting values for the menu items.  
For menus with sub-menus, values are not displayed.
- 6 Scroll Bar  
Indicates the scroll position.
- 7 Header  
Indicates the current menu type with the line color.
  - Blue : [Main Menu] Screen
  - Green : [Favorites Menu] (Operation screen)
  - Magenta : [Favorites Menu] (Editing screen)
- 8 Remaining Battery Power  
(P37 [Power Status Display])

Memo : \_\_\_\_\_

- If the supplied battery (or equivalent battery sold separately) is not used, the battery mark which indicates the battery level may not appear.

- 9 Menu Title  
Title of the currently displayed menu.

### Changing Setting Values

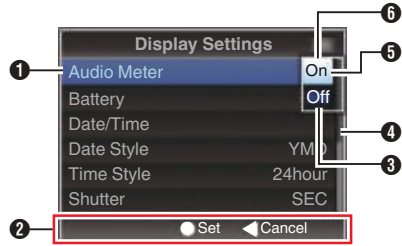

- 1 Menu Item to Change  
Menu item to be changed.  
A list of setting values 6 appears in a pop-up.
- 2 Operation Guide  
Guide for the current operation buttons.
- 3 Setting Values Before Change  
Setting values before changing. The background of the item is displayed in blue.
- 4 Scroll Bar  
Indicates the scroll position.
- 5 Cursor  
Indicates the selected item. Use the cross-shaped button (▲▼) to move the cursor
- 6 List of Setting Values
  - A pop-up displaying a list of setting values for selection.
  - The height of the pop-up depends on the number of settings available. Use the scroll bar 4 to confirm the current display status.

## Text Input with Software Keyboard

Use the software keyboard to enter the [Setup File] subname, [Clip Name Prefix], and the settings under [Network].

### Entering a subname

(☞ P172 [Configuring Setup Files])



### Entering the [Clip Name Prefix]

(☞ P154 [Clip Name Prefix])

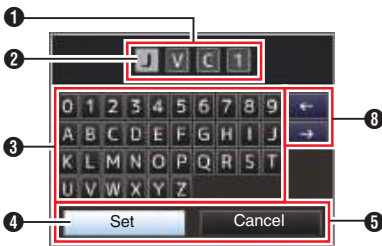

### Settings under [Network]

The keyboard displayed varies according to the settings.

(☞ P135 [Network Menu])

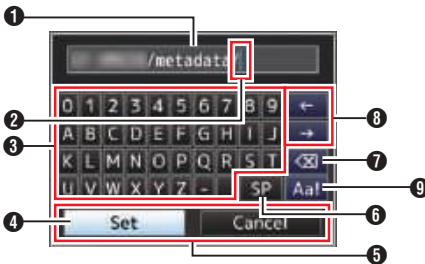

- 1 Character Entry Field
  - Field for entering the title.
  - You can enter up to 8 characters for the [Setup File] subname or up to 4 characters for the [Clip Name Prefix].
- 2 Character Cursor
 

Select a character using the key cursor 4, and press the Set button (●) to input the selected character at the position of the character cursor. The character cursor moves to the next position on the right each time a character is input. The cursor can be moved using the arrow keys 8.
- 3 Character Keys
 

Use the cross-shaped button (▲▼◀▶) to move the key cursor 4 to the character you want to enter.
- 4 Key Cursor
 

Indicates the currently selected character or item. Use the cross-shaped button (▲▼◀▶) to move the cursor.
- 5 Confirmation Buttons
  - Select [Set]/[Store] and press the Set button (●) to confirm the title.
  - Select [Cancel] and press the Set button (●) on the side control panel of the camera recorder to abort character input and return to the previous screen.
- 6 [SP] Space Key
 

Select [SP] and press the Set button (●) on the side control panel of the camera recorder to enter a space at the current position of the character cursor 2.
- 7 [X] Backspace Key
 

Select [X] and press the Set button (●) on the side control panel of the camera recorder to delete the character on the left of the character cursor 2.
- 8 Arrow Keys
 

Moves the position of the character cursor 2.
- 9 Character Switch Button
 

Switches the character buttons 3 to the upper case, lower case, and symbols.

# Menu Screen Hierarchical Chart

[Main Menu...]	(P 110)	[VF Bright]	(P 125)
[Camera Function...]	(P 111)	[VF Contrast]	(P 125)
[Bars]	(P 111)	[LCD Contrast]	(P 125)
[OIS]	(P 111)	[LCD Backlight]	(P 125)
[Shutter]	(P 111)	[LCD Mirror]	(P 125)
[AE Level]	(P 111)	[Convert to ITU709]	(P 125)
[AE Speed]	(P 111)	[LCD RGB Gain]	(P 126)
[AE Area]	(P 111)	[VF RGB Gain]	(P 126)
[AGC Limit]	(P 111)	[A/V Set...]	(P 130)
[Auto Iris Limit (OPEN)]	(P 112)	[Video Set...]	(P 130)
[Auto Iris Limit (CLOSE)]	(P 112)	[Audio Set...]	(P 132)
[EEI Limit]	(P 112)	[Network]	(P 135)
[Smooth Trans]	(P 112)	[Connection Setup...]	(P 135)
[GAIN L]	(P 112)	[Live Streaming...]	(P 135)
[GAIN M]	(P 112)	[Return over IP...]	(P 135)
[GAIN H]	(P 112)	[Web...]	(P 135)
[Zoom...]	(P 112)	[Metadata Server...]	(P 135)
[Focus...]	(P 112)	[Upload Settings]	(P 135)
[Face Detection...]	(P 112)	[Import Metadata]	(P 135)
[Infrared]	(P 113)	[Zero Config]	(P 136)
[User Switch Set...]	(P 113)	[Reset Network]	(P 136)
[KEYLOCK]	(P 113)	[Overlay Settings...]	(P 144)
[Menu Access]	(P 113)	[Overlay Function]	(P 144)
[Camera Angle[Tagging]]	(P 113)	[Layout]	(P 144)
[Camera Process...]	(P 118)	[Import User Layout]	(P 144)
[Color Space]	(P 118)	[Delete User Layout]	(P 144)
[Gamma]	(P 118)	[Type]	(P 144)
[Detail]	(P 119)	[Overlay Custom Menu]	(P 144)
[Master Black]	(P 119)	[Output...]	(P 144)
[Black Toe]	(P 120)	[Sportzcast]	(P 145)
[Knee]	(P 120)	[Watermark]	(P 145)
[White Clip]	(P 121)	[Full Screen Graphic...]	(P 145)
[White Balance...]	(P 121)	[Password Lock]	(P 145)
[Color Matrix]	(P 122)	[System...]	(P 147)
[Color Gain]	(P 122)	[Record Set...]	(P 147)
[Reverse Picture]	(P 122)	[Media]	(P 147)
[Reset Process]	(P 122)	[Setup File]	(P 147)
[TC/UB...]	(P 124)	[Tally Lamp]	(P 147)
[TC Generator]	(P 124)	[NETWORK LED]	(P 148)
[TC Preset]	(P 124)	[STATUS LED]	(P 148)
[UB Mode]	(P 124)	[LED Bright]	(P 148)
[Drop Frame]	(P 124)	[GPS]	(P 148)
[LCD/VF...]	(P 125)	[Language]	(P 148)
[Shooting Assist...]	(P 125)	[Reset All]	(P 148)
[Marker Settings...]	(P 125)	[Date/Time]	(P 148)
[Display Type...]	(P 125)	[Date Style]	(P 148)
[Display On/Off...]	(P 125)	[Time Style]	(P 149)
[VF Color]	(P 125)	[Time Zone]	(P 149)
		[Reserved]	(P 149)
		[System Information]	(P 149)

Memo :

- Some menus cannot be set depending on the operating mode or status of the camera recorder. These items are displayed in gray, and they cannot be selected.
- Setting value with the ● mark is the factory default.

\* The display of the [Overlay Custom Menu] changes according to the imported data.

# Camera Function Menu

Menu screen for specifying operation settings during shooting.

This item can only be selected in the Camera mode.

## Bars

For setting whether to output color bars.

[Setting Values: On, ●Off]

Memo : \_\_\_\_\_

- The audio test signals (1 kHz) can be output simultaneously with the color bar output. (P133 [ Test Tone ])

## OIS

For setting whether to enable image stabilizer. When “On” is selected, set the Level.

To turn on the [Hard Lock] function, configure OIS to “Off”.

[Setting Values: On, ●Off]

(P73 [Using the Image Stabilizer] )

### ↳ Level

For setting the level of the image stabilizer.

[Setting Values: High, ●Normal]

Memo : \_\_\_\_\_

- The icon changes according to the level set. (P161 [Image Stabilizer Mark] )
- When “High” is selected, correcting severe camera shake may cause the area surrounding the image to darken.

### ↳ Hard Lock

When the Hard Lock feature is “On”, the IS (image stabilization) lens is locked in place.

Use this feature when blurry image caused by camera shake tends to occur due to strong acceleration.

[Setting Values: On, ●Off]

(P73 [About the Hard Lock Feature] )

Memo : \_\_\_\_\_

- Camera shake that causes image blur occurs when switching between “On” and “Off”.

## Shutter

For specifying shutter-related settings.

Configure the value to “Step” (fixed value) or “Variable” when operating the shutter with the cross-shaped button (▲▼) on the side of the camera recorder unit.

- Variable:  
Sets to variable scan. Use this setting when shooting a PC monitor.
- Step:  
Sets to step shutter, which switches the shutter speed by a fixed value.

[Setting Values: Variable, ●Step]

## AE Level

For setting the convergence level during AE (Auto Exposure).

This can also be adjusted using the cross-shaped button (◀▶) on the side of the camera recorder unit.

[Setting Values: -6 to +6 (●0)]

## AE Speed

For setting the convergence speed during AE (Auto Exposure).

[Setting Values: ●Fast, Middle, Slow]

## AE Area

For configuring the AE detection area.

[Setting Values: Center, Bottom, ●Normal]

## AGC Limit

For setting the maximum gain value of “AGC”, which electrically boosts the sensitivity level according to the brightness automatically.

- When [LCD/VF] → [Display Type] → [Gain] is set to “dB”:  
[Setting Values: 24 dB, ●18 dB, 12 dB, 6 dB]
- When [LCD/VF] → [Display Type] → [Gain] is set to “ISO”:  
[Setting Values: ISO 12800, ●ISO 6400, ISO 3200, ISO 1600]

Memo : \_\_\_\_\_

- When [FULL AUTO] is set to “ON”, this item appears as “---” and cannot be selected.

**Auto Iris Limit (OPEN)**

For setting the limit value of the OPEN end when auto iris is enabled.

[Setting Values: F5.6, F4, Open]

Memo : \_\_\_\_\_

- When [FULL AUTO] is set to "ON", this item appears as "---" and cannot be selected.

**Auto Iris Limit (CLOSE)**

For setting the limit value of the CLOSE end when auto iris is enabled.

[Setting Values: F16, ●F11, F8, F5.6]

Memo : \_\_\_\_\_

- When [FULL AUTO] is set to "ON", this item appears as "---" and cannot be selected.

**EEl Limit**

For setting the shutter speed control range when the Automatic Shutter mode (EEI) is enabled.

[Setting Values: 4F-stop, ●3F-stop, 2F-stop]

Memo : \_\_\_\_\_

- When [FULL AUTO] is set to "ON", this item appears as "---" and cannot be selected.

**Smooth Trans**

For setting the shock reduction function, which slows down the sudden change when switching with the [GAIN] or [WHT BAL] switch.

[Setting Values: Fast, Middle, Slow, ●Off]

Memo : \_\_\_\_\_

- This function is disabled when AGC is operating.
- When "J-Log1" or "HLG" is selected for [Camera Process] → [Color Space], the setting is fixed at "Off" and the selection cannot be changed.

**GAIN L, GAIN M, GAIN H**

For setting the gain value of each position on the [GAIN] selection switch.

The setting is fixed at "AGC" in the Full Auto mode. In addition, the sensitivity setting in [Lolux] is used.

- (☞ P116 [ Lolux ] )
- When [LCD/VF] → [Display Type] → [Gain] is set to "dB":  
[Setting Values: 24 dB, 21 dB, 18 dB, 15 dB, 12 dB, 9 dB, 6 dB, 3 dB, 0 dB, -3 dB, -6 dB]  
(Default values for GAIN L: 0dB, GAIN M: 6dB, GAIN H: 12dB)
- When [LCD/VF] → [Display Type] → [Gain] is set to "ISO" and [Camera Process] → [Color Space] is set to a value other than "HLG":  
[Setting Values: ISO12800, ISO10000, ISO8000, ISO6400, ISO5000, ISO4000, ISO3200, ISO2500, ISO2000, ISO1600, ISO1250, ISO1000, ISO800, ISO640, ISO500, ISO400]  
(Default values for GAIN L: ISO800, GAIN M: ISO1600, GAIN H: ISO3200)

Memo : \_\_\_\_\_

- When "J-Log1" is selected for [Camera Process] → [Color Space], the base ISO speed for achieving the 800% dynamic range of [J-Log1] is "[ISO1250]". The square brackets appear only in the case of the base ISO.

**Zoom...**

For specifying zoom settings.

(☞ P113 [Zoom Function Settings] )

**Focus...**

For specifying focus settings.

(☞ P114 [Focus Function Settings] )

**Face Detection...**

For specifying face detection settings.

(☞ P115 [Face Detection Function Settings] )



## Infrared

When “On” is selected, an  icon appears and the camera recorder switches to the infrared recording mode that is suitable for night recording. Using infrared illumination allows images to be captured naturally in a pitch-dark environment. It is recommended for observation of animals without alerting them or for natural facial expressions without firing glaring flash light at the subject. [Setting Values: On, ●Off]

Caution : \_\_\_\_\_

- Do not use infrared recording for capturing strong light sources or heat sources. Doing so may damage the camera recorder.

Memo : \_\_\_\_\_

- This is fixed at “Off” when [FULL AUTO] is set to “ON”.
- The settings are fixed as followed when it is configured to “On”.
  - Manual focus
  - ND filter “OFF”
  - [Camera Function] → [Focus] → [AF Assist] and [MF Assist] appear as “---”.
  - All items other than [Color Space] and [Reverse Picture] under [Camera Process] appear as “---”.
- The zoom and focus positions will be initialized after the settings are changed.
- When [Infrared] is configured to “On”, if the type of light source changes after focus is established, the image may go out of focus.

## User Switch Set...

For specifying user button related settings. (P116 [User Switch Set Item] )

## KEYLOCK

For specifying the settings when the [KEYLOCK] switch is set to “ON”.  
[Setting Values: ●Keylock Except Rec, Keylock All]

## Menu Access

For specifying settings on the behavior when accessing the menu using the [MENU/THUMB] button.  
[Setting Values: Press and Hold, ●One Press]

## Camera Angle[Tagging]

For specifying tagging settings for the camera angle.  
[Setting Values: SB, ●SL, EZ, SL2, EZ2, TV]

## Zoom Function Settings

### Dynamic Zoom

For setting whether to enable the dynamic zoom function.

- On:  
Enables the dynamic zoom (1x to 40x).
- Off:  
Enables only the optical zoom (1x to 20x).

[Setting Values: On, ●Off]

Memo : \_\_\_\_\_

- When [System] is set to “4K EXT (SSD)”, “4K” or “High-Speed”, this item is fixed at “Off” and cannot be selected.
- When [Digital Extender] is set to “On”, “Off” becomes fixed and cannot be selected.

### ↳ Response

For specifying the speed of zoom response when Dynamic Zoom is “On”.

[Setting Values: Slow, ●Normal]

Memo : \_\_\_\_\_

- When [Dynamic Zoom] is “Off”, this item appears as “---” and cannot be selected.

### Digital Extender

For specifying whether to magnify the image (by 2 times). When “On” is selected, a  icon appears.

[Setting Values: On, ●Off]

Memo : \_\_\_\_\_

- When [System] is set to “4K EXT (SSD)”, “4K” or “High-Speed”, this item is fixed at “Off” and cannot be selected.
- When [Dynamic Zoom] is set to “On”, “Off” becomes fixed and cannot be selected.

### Handle Zoom Speed

This function allows you to set the zoom speed of the zoom lever at the handle when the [ZOOM FIX/VAR/OFF] switch is set to “FIX”.

[Setting Values: 1 to 8 (●5)]

**Focus Tracking**

For specifying whether to track the focus during zooming.

- On:  
Tracks the focus during zooming.
- Off:  
Gives priority to the zoom speed and does not track the focus during zooming.

[Setting Values: ●On, Off]

Memo : \_\_\_\_\_

- Zoom speed may be affected when zooming is performed near the tele-end.

**Preset Zoom**

For setting the speed for shifting to the preset zoom position and the rate of change for starting and stopping the preset zoom operation of the preset zoom function assigned to the user button.

**↳ Speed**

For setting the speed to shift to the preset zoom position.

[Setting Values: 1 to 21 (●11)]

**↳ Ease In**

For setting the rate of change from the start of the zoom operation until the predetermined [Speed] is reached.

The larger the setting value, the longer it takes to reach the value specified in Speed.

[Setting Values: 1 to 5, ●Off]

**↳ Ease Out**

For setting the rate of change from the predetermined [Speed] until the zoom operation stops.

The larger the setting value, the longer it takes before the operation stops.

[Setting Values: 1 to 5, ●Off]

**REMOTE Zoom Ease**

For specifying whether to zoom in or zoom out slowly when zoom operation starts or during zooming using a wired remote control.

[Setting Values: ●On, Off]

**Web Zoom Ease**

For specifying whether to zoom in or zoom out slowly when zoom operation starts or during zooming using the View Remote feature.

[Setting Values: ●On, Off]

**Focus Function Settings****AF Assist**

For specifying the behavior when the focus ring is turned during AF.

- Direction:  
This option allows you to shift the auto focus point to near and far directions by turning the focus ring during AF.
- Manual:  
Temporarily switches to MF when the focus ring is turned during AF.
- Off:  
Sets the AF Assist function to “Off”.

[Setting Values: Direction, Manual, ●Off]

Memo : \_\_\_\_\_

- This setting is effective only when the [FOCUS] switch is set to “AUTO”.

**AF Speed**

For setting the AF operation speed.

[Setting Values: Fast, ●Middle, Slow]

**AF Sensitivity**

For specifying the sensitivity of AF in response to changes in the photographic subject.

- High: High sensitivity
- Middle: Normal
- Low: Low sensitivity

[Setting Values: High, ●Middle, Low]

**AF Area**

For configuring the AF area.

- Multi:  
Automatically configures to an area optimal for recording.
- Wide:  
Extends the AF area sideways.
- Normal:  
Performs AF at the area near the center of the image.

[Setting Values: Multi, Wide, ●Normal]

**MF Assist**

For specifying the behavior when the focus ring is turned during MF.

- On:  
Turning the focus ring during MF activates AF for a short interval after the operation, after which the camera recorder returns to the MF mode. However, it does not function while in the expanded focus mode.
- Off:  
Does not switch temporarily to AF when the focus ring is turned during MF.

[Setting Values: On, ●Off]

**Limiter**

For specifying the closest focusing distance. When [LCD/VF] → [Display Type] → [Focus] is set to "Meter":

[Setting Values: 5 m - ∞, 3 m - ∞, 1 m - ∞, ●Off]

When [LCD/VF] → [Display Type] → [Focus] is configured to "Feet":

[Setting values: 16 ft - ∞, 10 ft - ∞, 3 ft - ∞, ●Off]

**AF Hold during Zoom**

For specifying AF operation during zoom operation.

- Hold:  
Constricts AF operation and performs silent zooming during the zoom operation.
- Off:  
Activates AF operation during zooming.

[Setting Values: Hold, ●Off]

**Face Detection Function Settings****Mode**

For configuring the behavior when operating the user button that is assigned with the "Face Detection" function in the Auto Focus mode. Select the control to track results of face detection.

- AF&AE:  
Sets auto focus and exposure control for the face that is being tracked.
- AF:  
Sets auto focus for the face that is being tracked.

[Setting Values: ●AF&AE, AF]

( P62 [Adjusting the Focusing by Face Detection] )

Memo : \_\_\_\_\_

- When "AF&AE" is selected, this function will be activated when the [FOCUS AUTO/MANU] switch is set to "AUTO" and when at least one of the Iris, Shutter and Gain items is configured to Auto mode.
- When "AF" is specified, this function will be activated only when the [FOCUS AUTO/MANU] switch is set to "AUTO".

**Face Only AF**

For activating auto focusing only for the face of the subject.

[Setting Values: On, ●Off]

Memo : \_\_\_\_\_

- When a face cannot be detected when this is configured to "On", the camera recorder switches to manual focusing.

**Sensitivity**

For setting the level of ease of face detection.

[Setting Values: ●High, Middle, Low]

**Holding Duration**

For specifying duration to maintain the current focus when the camera loses track of the face. Set to "Short" to select another object immediately if the face on the screen is lost.

Set to "Long" to operate at the same position for some time even if the face on the screen is lost.

[Setting Values: Long, ●Normal, Short]

## User Switch Set Item

### USER1 to USER9, USER10 ▲, USER11 ▼, USER12 ◀, USER13 ▶

Assigning one of the functions in the following menu to the [FOCUS ASSIST/1], [OIS/2], [ONLINE/3], [AE LOCK/4], [ZEBRA/5], [MARKER/6], [USER7], [USER8] or [EXP.FOCUS/9] button or the [▲/10], [▼/11], [◀/12] or [▶/13] front cross-shaped button enables operation of the said preconfigured function (on/off, launching, switching).

Set according to the shooting conditions. Usable in the Camera mode.

(P46 [Assignment of Functions to User Buttons])

[Setting Values: Cancel, Menu, Slot Select, Return Video, Return over IP, Auto Upload, Live Streaming, Load Picture File, Clip Review, OK Mark, Clip Cutter Trig, Backup Trig, Rec, LCD Backlight, Spot Meter, Focus Assist, Expanded Focus, Focus Assist +, Marker, Histogram, Zebra, AWB, White Balance, Preset Zoom3, Preset Zoom2, Preset Zoom1, Digital Extender, OIS, Black Compress, Black Stretch, Face Only AF, Face Detection, AE Lock, Lolux, Bars, None]

Memo : \_\_\_\_\_

- “Cancel” and “Menu” can only be assigned to [USER7] or [USER8].
- “Rec” cannot be assigned to [FOCUS ASSIST/1], [OIS/2] and [ONLINE/3].
- “Focus Assist +” is a combination of the “Focus Assist” and “Expanded Focus” functions.
- The following functions can be assigned only for GY-HC500SPCU.  
[ODK Tagging]OFF, [ODK Tagging]KO, [ODK Tagging]KOR, [ODK Tagging]P, [ODK Tagging]PR, [ODK Tagging]FG, [ODK Tagging]FGB, [ODK Tagging]REMOVE

## Lolux

To increase the sensitivity when in dim surroundings, set a value in the Lolux mode.

- When [LCD/VF] → [Display Type] → [Gain] is set to “dB”:  
[Setting Values: ●36 dB, 30 dB]
- When [LCD/VF] → [Display Type] → [Gain] is set to “ISO”:  
[Setting Values: ●ISO 51200, ISO 25600]

## Clip Review

For configuring the behavior when operating the user button that is assigned with the “Clip Review” function.

- Last 5sec:  
Views about 5 seconds of the clip from the ending.
- Top 5sec:  
Views about 5 seconds of the clip from the beginning.
- Clip:  
Views the entire clip.

[Setting Values: ●Last 5sec, Top 5sec, Clip]

## Spot Meter

For configuring the behavior when operating the user button that is assigned with the “Spot Meter” function.

- Max & Min:  
Displays the brightest and darkest areas of the image.
- Max:  
Displays the brightest area of the image.
- Min:  
Displays the darkest area of the image.
- Manual:  
Displays the image brightness at a specified position.

[Setting Values: ●Max & Min, Max, Min, Manual]

Memo : \_\_\_\_\_

- When “HLG” is selected in [Camera Process] → [Color Space], the value of the spot meter changes according to the setting of [LCD/VF] → [Convert to ITU709]/[White Level].

## AE Lock

For configuring the behavior when operating the user button that is assigned with the “AE Lock” function.

- **FAW:**  
Use this to fix the FAW (Full-time Auto White Balance) function to the value when the user button assigned with “AE Lock” is pressed.
- **AE:**  
Use this to fix the Auto function of Gain, Iris, or Shutter to the value when the user button assigned with “AE Lock” is pressed.
- **AE/FAW:**  
Use this to fix the FAW (Full-time Auto White Balance) function and the Auto function of Gain, Iris, or Shutter to the value when the user button assigned with “AE Lock” is pressed.

[Setting Values: FAW, ●AE, AE/FAW]

Memo : \_\_\_\_\_

- This feature only works when Iris, Shutter, Gain or White Balance is set to Auto mode.
- “AE Lock” is canceled when the user button assigned with “AE Lock” is pressed, or when any of the functions that can be locked is operated regardless of the mode (Manual or Auto).
- “AE Lock” is canceled in the following cases.
  - When the user button that is assigned with “AE Lock” is pressed
  - When changes are made to the iris, gain or shutter settings
  - When changes are made to the AE level
  - When there is a switch between the Camera and Media modes

## Expanded Focus

For configuring the behavior when operating the user button that is assigned with the “Expanded Focus” function.

- **Limited Time:**  
Activates the timer.  
Turns off the “Expanded Focus” function about 3 seconds after the user button assigned with “Expanded Focus” is pressed.
- **Momentary:**  
The “Expanded Focus” function is enabled during the interval while the user button assigned with “Expanded Focus” is pressed.
- **Toggle:**  
Pressing the user button assigned with “Expanded Focus” each time switches the “Expanded Focus” function to on or off.

[Setting Values: Limited Time, Momentary, ●Toggle]

Memo : \_\_\_\_\_

- When one of the [▲/10], [▼/11], [◀/12], [▶/13] buttons is assigned with “Expanded Focus” and “Toggle” is selected, press the [CANCEL] button to turn off the function.

# Camera Process Menu

Menu screen for adjusting the quality of camera images.

This item cannot be selected in the Media mode.

## Color Space

For configuring the color space that is used inside the camera.

The gamma and color gamut change automatically according to the selected color space.

When [System] is configured to a setting other than "SD"

- J-Log1:  
Color space that supports 800% dynamic range and log gamma
- HLG:  
Color space that supports the ITU2100 HLG HDR
- ITU2020:  
Color space that supports the ITU2020 wide color gamut
- ITU709:  
ITU709 color space

[Setting Values: J-Log1, HLG, ITU2020, ●ITU709]

When [System] is set to "SD"

- ITU601 (EBU):  
Color space that supports the EBU color gamut
- ITU601 (170M):  
Color space that supports the SMPTE170M color gamut
- ITU709:  
ITU709 color space

[Setting Values: ITU601 (EBU), ITU601 (170M), ●ITU709]

Memo : \_\_\_\_\_

- When [System] is configured to a setting other than "SD" and "J-Log1" or "HLG" is selected, some menu items under [Camera Process] cannot be configured.
- The AE function does not function when "J-Log1" or "HLG" is selected.

## ↳ Colorimetry

For configuring the standard for converting R, G, B signals to Y, Cb, Cr signals when [Color Space] is configured to "HLG" or "ITU2020".

- ITU2020:  
Records and outputs ITU2020 RGB signals using the Y-Cb-Cr signal conversion coefficient.
- ITU709:  
Records and outputs ITU709 RGB signals using the Y-Cb-Cr signal conversion coefficient.

[Setting Values: ●ITU2020, ITU709]

Memo : \_\_\_\_\_

- This item is available when [Color Space] is set to "HLG" or "ITU2020".
- This is fixed at "ITU709" when [Color Space] is set to "J-Log1" or "ITU709".
- This is fixed at "ITU601" when [System] is set to "SD".

## Gamma

For adjusting the gamma curve that determines the gradation expression.

( P170 [Adjusting the Gamma])

- Cinema 2:  
Sets to a gamma curve with soft expression giving priority to high luminance gradation.
- Cinema 1:  
Sets to a gamma curve with similar gradation to the screen characteristics of movies.
- Standard:  
Sets to a standard gamma curve.

[Setting Values: Cinema 2, Cinema 1, ●Standard]

Memo : \_\_\_\_\_

- [Gamma] cannot be configured when [Color Space] is set to "HLG" or "J-Log1". "HLG Gamma" is used during "HLG" and "J-Log1 Gamma" is used during "J-Log1".
- This item cannot be configured when [Infrared] is set to "On".

## ↳ Level

The amount of correction can be specified separately when [Gamma] is set to “Standard”, “Cinema 1” or “Cinema 2”.

When [Gamma] is set to “Standard”

[Setting Values: 0.35 to ● 0.45 to 0.55 (in steps of 0.02)]

- Increase the number:  
Finer gradation at bright areas and coarser gradation at dark areas.
- Decrease the number:  
Finer gradation at dark areas and coarser gradation at bright areas.

When [Gamma] is set to “Cinema 1” or “Cinema 2”

[Setting Values: +5 to ● 0 to -5]

- Increase the number:  
Finer gradation at dark areas and coarser gradation at bright areas.
- Decrease the number:  
Finer gradation at bright areas and coarser gradation at dark areas.

Memo : \_\_\_\_\_

- When [Gamma] is set to “Standard” with the value set at [0.45], the gamma adjusted conforms to ITU709 or ITU2020.
- If [Gamma] is set to “Cinema 2”, the maximum peak signal decreases from 109% as the number becomes smaller in the setting values from 0 to -5. When the level is at -5, the video input with a dynamic range of 400% will be kept within a 100% output.
- This item cannot be configured when [Color Space] is configured to “HLG” or “J-Log1”.
- This item cannot be configured when [Infrared] is set to “On”.

## Detail

For adjusting the contour (detail) enhancement level.

Increasing the value increases the sharpness of the contour.

[Setting Values: +10 to -10, Off]

(Default Value: -6 for “J-Log1” and “HLG” of Color Space; 0 for all other settings)

Memo : \_\_\_\_\_

- The setting values of this item and [Adjust...] are stored separately when [Color Space] is set to “HLG” or “J-Log1”.
- This item cannot be configured when [Infrared] is set to “On”.

## ↳ Frequency

For specifying the correction frequency of the contour. Set this according to the object.

- High:  
Emphasizes the high frequency range. Use this when shooting objects with fine patterns.
- Middle:  
Emphasizes the intermediate frequency range.
- Low:  
Emphasizes the low frequency range. Use this when shooting objects with large patterns.

[Setting Values: High, ●Middle, Low]

Memo : \_\_\_\_\_

- Available when [System] is set to “4K EXT (SSD)” or “4K”.
- This item cannot be configured when [Infrared] is set to “On”.

## Master Black

For adjusting the pedestal level (master black) that serves as the reference black.

Increasing the value increases the pedestal.

[Setting Values: +50 to -50 (●-3)]

Memo : \_\_\_\_\_

- This item cannot be configured when [Color Space] is set to “J-Log1”.
- The setting value of this item is stored separately when [Color Space] is set to “HLG”.
- This item cannot be configured when [Infrared] is set to “On”.

**Black Toe**

Process the dark areas according to the balance of bright and dark areas in the image to adjust the overall balance of contrast.

For altering the gain of dark areas. Adjust this item according to the condition of the captured video signals.

- **Stretch:**  
Increases the gain of dark areas in an image to stretch the signals of these areas only, thereby showing the contrast between bright and dark areas more clearly.  
Specify the amount of stretch with [Stretch Level].

- **Normal:**  
Normal condition.

- **Compress:**  
Compresses the gain of dark areas to increase the contrast when the entire image appears bright and contrast is weak. Specify the compression amount with [Compress Level].

[Setting Values: Stretch, ●Normal, Compress]

Memo : \_\_\_\_\_

- This item cannot be configured when [Color Space] is set to “J-Log1” or “HLG”.
- This item cannot be configured when [Infrared] is set to “On”.

**↳ Stretch Level**

Stretch amount increases when a larger value is specified.

[Setting Values: 5 to 1 (●3)]

Memo : \_\_\_\_\_

- This item is displayed only when [Black Toe] is set to “Stretch”. Otherwise, this item appears as “---” and cannot be selected.
- This item cannot be configured when [Color Space] is set to “J-Log1” or “HLG”.
- This item cannot be configured when [Infrared] is set to “On”.

**↳ Compress Level**

Compression amount increases when a larger value is specified.

[Setting Values: 5 to 1 (●3)]

Memo : \_\_\_\_\_

- This item is displayed only when [Black Toe] is set to “Compress”. Otherwise, this item appears as “---” and cannot be selected.
- This item cannot be configured when [Color Space] is set to “J-Log1” or “HLG”.
- This item cannot be configured when [Infrared] is set to “On”.

**Knee**

For specifying the “Knee” operation, which compresses video signals beyond a certain level to show the gradation of the highlighted portion. To check the gradation of a bright area, set to “Manual” and adjust the knee point (starting point of knee operation) manually.

- **Manual:**  
Enables manual adjustment of knee point using [Level].
- **Auto:**  
Adjusts the knee point automatically according to the luminance level.

[Setting Values: Manual, ●Auto]

Memo : \_\_\_\_\_

- This item cannot be configured when [Color Space] is set to “J-Log1” or “HLG” and when [Gamma] is set to “Cinema 2”.
- This item cannot be configured when [Infrared] is set to “On”.

**↳ Level**

For setting the starting point (knee point) of knee compression when [Knee] is set to “Manual”.

[Setting Values: 100.0%, 97.5%, ●95.0%, 92.5%, 90.0%, 87.5%, 85.0%, 82.5%, 80.0%, 77.5%, 75.0%, 72.5%, 70.0%]

Memo : \_\_\_\_\_

- This item cannot be configured when [Knee] is set to “Auto”.
- This item cannot be configured when [Color Space] is set to “J-Log1” or “HLG” and when [Gamma] is set to “Cinema 2”.
- This item cannot be configured when [Infrared] is set to “On”.



### ↳ Sensitivity

For setting the response speed of the “Knee” operation when [Knee] is set to “Auto”. Set to “Slow” when shooting an object under a condition where there is drastic change in the light intensity.

[Setting Values: ●Fast, Middle, Slow]

Memo : \_\_\_\_\_

- This item cannot be configured when [Knee] is set to “Manual”.
- This item cannot be configured when [Color Space] is set to “J-Log1” or “HLG” and when [Gamma] is set to “Cinema 2”.
- This item cannot be configured when [Infrared] is set to “On”.

### ↳ Peak Filter

For configuring the response speed of the “Knee” operation with respect to a high-luminance point light source and the like when [Knee] is configured to “Auto”.

[Setting Values: ●High, Middle, Low]

Memo : \_\_\_\_\_

- This item cannot be configured when [Knee] is set to “Manual”.
- This item cannot be configured when [Color Space] is set to “J-Log1” or “HLG” and when [Gamma] is set to “Cinema 2”.
- This item cannot be configured when [Infrared] is set to “On”.

### White Clip

For setting the point to apply white clip for video signals with a high luminance level.

- 109%:  
Applies white clip at the point where the luminance level is 109%.
- 103%:  
Applies white clip at the point where the luminance level is 103 %.
- 100%:  
Applies white clip at the point where the luminance level is 100 %. Set to this value when the system in use limits Y output signals within 100 %.

[Setting Values: ●109%, 103%, 100%]

Memo : \_\_\_\_\_

- The setting value of this item is stored separately when [Color Space] is set to “HLG” or “J-Log1”.
- This item cannot be configured when [Infrared] is set to “On”.

### White Balance...

Menu for adjusting white balance.  
( P123 [White Balance Item] )

- \* For details, refer to “[Adjusting the White Balance] ( P 69)”.

**Color Matrix**

For setting the color matrix.

- **Natural:**  
Sets to a brighter and more natural color matrix than the standard. Effective for shooting under a strong single color light source such as stage lightings.
- **Cinema Subdued:**  
Sets to a subdued color matrix that is similar to the screen characteristics of movies.
- **Cinema Vivid:**  
Sets to a vivid color matrix that is similar to the screen characteristics of movies.
- **Standard:**  
Sets to a standard color matrix.
- **Off:**  
Sets the color matrix function to Off.

[Setting Values: Natural, Cinema Subdued, Cinema Vivid, ●Standard, Off]

Memo : \_\_\_\_\_

- This item cannot be configured when [Color Space] is set to “J-Log1” or “HLG”.
- This item cannot be configured when [Infrared] is set to “On”.

**↳ Adjust**

This item is used to adjust [Color Matrix] to a color according to the user's preference. The adjusted values of “Natural”, “Standard”, “Cinema Vivid”, and “Cinema Subdued” in [Color Matrix] can be stored individually.

- The saturation and hue of Red, Green and Blue can be configured individually.

[Setting range for Saturation: -10 to +10] (roughly ± 10%)

[Setting range for Hue: -10 to +10]  
(P171 [Adjusting Color Matrix] )

Memo : \_\_\_\_\_

- This item cannot be configured when [Color Space] is set to “J-Log1”.
- This item cannot be selected when [Color Matrix] is set to “Off”.
- This item cannot be configured when [Infrared] is set to “On”.

**Color Gain**

For adjusting the video signal color level.

Increasing the value deepens the color.

[Setting Values: +15 to -50, Off (●0)]

Memo : \_\_\_\_\_

- Images are displayed in black-and-white when this is set to “Off”.
- This item cannot be configured when [Color Space] is set to “J-Log1”.
- The setting value of this item is stored separately when [Color Space] is set to “HLG”.
- This item cannot be configured when [Infrared] is set to “On”.

**Reverse Picture**

For recording images correctly by setting this item to “Rotate” when the lens image appears upside down or laterally inverted.

- **Rotate:**  
Enables horizontal/vertical inversion of the image.
- **Off:**  
Disables horizontal/vertical inversion of the image.

[Setting Values: Rotate, ●Off]

**Reset Process**

Restores all items in the [Camera Process] menu to their default settings.

## White Balance Item

### Preset Temp.

For setting the color temperature when the [WHT BAL] switch is set to "PRESET".

For details, refer to "[Adjusting the White Balance] (P 69)".

### Alternative Temp.

For setting the alternative color temperature in the Preset mode.

When the [WHT BAL] switch is set to "PRESET", pressing the [●] or the user button assigned with the "AWB" function each time switches the color temperature setting in the Preset mode. ([Preset Temp.] ↔ [Alternative Temp.]

For details, refer to "[Adjusting the White Balance] (P 69)".

### Preset Paint Memory

For configuring whether to configure the color temperature individually or collectively in the Preset mode. Adjustment is performed in [Preset Paint].

- Individual:  
Each of the 9 types of color temperatures (2300K, 3000K, 3200K, 4200K, 4800K, 5200K, 5600K, 6500K, 7500K) are configured individually.
- Common:  
The entire color temperature range is configured collectively.

[Setting Values: Individual, ●Common]

### Preset Paint

For adjusting the R (red) and (B) blue components in the Preset mode.

- Increase the number:  
Strengthens the red/blue.
- Decrease the number:  
Weakens the red/blue.

[Setting Values: +32 to -32 (● 0)]

### AWB Paint

For adjusting the R (red)/B (blue) component in the AWB (Auto White Balance) mode.

For details, refer to "[Adjusting the White Balance] (P 69)".

- Increase the number:  
Strengthens the red/blue.
- Decrease the number:  
Weakens the red/blue.

[Setting Values: -32 to +32 (● 0)]

Memo : \_\_\_\_\_

- This item is selectable when the [WHT BAL] switch is set to "A" or "B". When "PRESET" is set, this item appears as "---" and cannot be selected.
- Different values can be specified for "A" and "B".
- When [Clear Paint After AWB] is configured to "On", pressing the [●] button or the user button assigned with the "AWB" function to readjust the white balance switches the R and B values to "0".

### Clear Paint After AWB

For specifying whether to clear the [AWB Paint] (R value and B value) settings after executing AWB (Auto White Balance).

- On:  
Sets the [AWB Paint] (R value and B value) settings to "0" after executing AWB (Auto White Balance).
- Off:  
Does not change the [AWB Paint] (R value and B value) settings after executing AWB (Auto White Balance).

[Setting Values: ●On, Off]

### FAW Paint

For adjusting the R (red)/B (blue) component during FAW (Full Auto White Balance) mode.

- Increase the number:  
Strengthens the red/blue.
- Decrease the number:  
Weakens the red/blue.

[Setting Values: -32 to +32 (● 0)]

# TC/UB Menu

Menu screen for setting time code and user's bit. This item cannot be selected in the Media mode, or during recording.

## TC Generator

For setting the operation of the time code.

- **Free Run(GPS) SPC:**  
Time code information can be synchronized with the date/time information acquired from the GPS.
- **Free Run(Ext):**  
External time code input will be synchronized with this and the time code will be recorded.
- **Free Run:**  
The time code operates in the run mode at all times regardless of the recording status. It continues to run even when the power of the camera recorder is turned off.
- **Rec Run:**  
The time code operates in the run mode during recording. It continues to run in the order of the recorded clips as long as the SD card is not replaced. If the SD card is removed and recording is made on another card, time code will be recorded on the new card from where it was left off in the previous card.
- **Regen:**  
The time code operates in the run mode during recording. When the SD card is replaced, the last time code recorded on the card is read and recorded on a new card so that the time code continues in running order.

[Setting Values: Free Run(GPS), SPC, Free Run(Ext), Free Run, ●Rec Run, Regen]

Memo : \_\_\_\_\_

- When [Rec Mode] is configured to "Interval Rec" or "Frame Rec", only "Rec Run" and "Regen" are selectable.
- When [System] is configured to "High-Speed", only "Rec Run" and "Regen" are selectable.
- When [Frame Rate] is set to "24p", "Free Run(GPS)" cannot be selected.

## TC Preset

For setting the time code (hour, minute, second, frame).

Display : Drop setting 02:02:25.20  
          : Non Drop setting 02:02:25:20  
(P77 [Setting Time Code Generator])

## UB Mode

For setting the recording mode of the user's bit.

- **Date:**  
Records the date.
- **Time:**  
Records the time.
- **Preset:**  
Records according to the preset setting.  
(P80 [Setting the User's Bit])

[Setting Values: Date, Time, ●Preset]

Memo : \_\_\_\_\_  
• If [UB Mode] is set to "Time", the user's bit operates in the 24-hour format even if the LCD display is in the 12-hour format.

## ↳ Preset

For setting the user's bit. (Digit by digit)

Display : AB CD EF 01  
(P80 [Presetting the User's Bit])

Memo : \_\_\_\_\_  
• When [UB Mode] is set to "Date" or "Time", this item appears as "---" and preset is disabled.  
• When [TC Generator] is set to "Regen", this item appears as "<Regen>" and preset is disabled.

## Drop Frame

For setting the framing mode of the time code generator.

- **Non Drop:**  
Internal time code generator works in the non-drop-frame mode. Use this setting when placing emphasis on the number of frames.
- **Drop:**  
Internal time code generator works in the drop-frame mode. Use this setting when placing emphasis on the recording time.

[Setting Values: Non Drop, ●Drop]

Memo : \_\_\_\_\_  
• This item can be set only when [System] → [Record Set] → [Record Format] → [AFrame Rate] is set to "60p", "30p", or "60i". However, when "Free Run(GPS)" is selected for [TC Generator], this item is fixed at "Drop" and cannot be selected. SPC  
• When [Frame Rate] is "24p", "Non Drop" becomes fixed and cannot be selected.  
• When [Frame Rate] is "50p", "25p", or "50i", this item appears as "---" and cannot be selected.  
(P151 [AFrame Rate/ EXTFrame Rate])

# LCD/VF Menu

Item for specifying settings related to the LCD monitor or viewfinder screen.

This menu screen can be used to specify settings related to the Focus Assist mode, zebra pattern display, screen size, marker, and safety zone. In addition, it is also used for selecting whether to display characters on the LCD monitor or viewfinder screen, as well as for adjusting the picture quality of the LCD monitor.

## Shooting Assist...

Menu for setting the Shooting Assist function.  
( P126 [Shooting Assist Item] )

## Marker Settings...

For setting items such as the safety zone and center mark.  
( P127 [Marker Settings Item] )

## Display Type...

For specifying display-related settings.  
( P128 [Display Type Item] )

## Display On/Off...

For configuring the on/off setting of the screen display.  
( P129 [Display On/Off Item] )

## VF Color

For selecting whether to display the image on the viewfinder screen in color or black-and-white. Select "On" to display in color, and "Off" to display in black-and-white.  
[Setting Values: ●On, Off]

## VF Bright

For setting the brightness of the viewfinder screen. Increasing the value increases the brightness.  
[Setting Values: +10 to +1, ●0, -1 to -10]

## VF Contrast

For setting the difference in luminance between the darkest and brightness areas in the viewfinder screen. Increasing the value increases the contrast.  
[Setting Values: +10 to +1, ●0, -1 to -10]

## LCD Contrast

For setting the difference in luminance between the darkest and brightness areas in the LCD monitor. Increasing the value increases the contrast.  
[Setting Values: +10 to +1, ●0, -1 to -10]

## LCD Backlight

For setting the brightness of the LCD monitor backlight. Increasing the value increases the brightness.  
[Setting Values: +1, ●0, -1]

## LCD Mirror

For specifying the image display method when facing the LCD monitor. Select "Mirror" to display the image after laterally inverting it. (Mirror display)  
( P43 [Adjusting the LCD Monitor and Viewfinder] )  
[Setting Values: Mirror, ●Normal]

Memo : \_\_\_\_\_

- The setting of this item is valid only in Camera mode.
- During color bar, expanded focus, menu screen and status screen display, the "Mirror" setting is disabled.  
( P169 [Color Bar Output] )

## Convert to ITU709

When [Color Space] is set to "ITU2020", "J-Log1" or "HLG", the video images on the LCD monitor and viewfinder are converted to the ITU709 color space for display.

- Cam + Return:  
The camera and return videos are converted from the color space configured in [Color Space] to the ITU709 color space.
  - Cam:  
Only the camera video is converted to the ITU709 color space.
  - Off:  
Not converted.
- [Setting Values: Cam + Return, Cam, ●Off]

Memo : \_\_\_\_\_

- This item can be configured only when [Color Space] is set to "ITU2020", "J-Log1" or "HLG".

### ↳ White Level

For configuring the white level during adjustment of the dynamic range that is visible in the LCD monitor or viewfinder when [Color Space] is set to "HLG". When [Color Space] is set to "HLG" and [Convert to ITU709] is set to a value other than "Off", this item can be used to configure the output luminance level (%) of HLG videos that corresponds to 100% on the ITU709 gamma curve during the conversion. [Setting Values: 80.0%, 77.5%, 75.0%, ● 72.5%, 70.0%, 67.5%, 65.0%, 62.5%, 60.0%, 57.5%, 55.0%, 52.5%, 50.0%]

Memo : \_\_\_\_\_

- This item can be configured only when [Color Space] is set to "HLG".
- The value on the spot meter changes in tandem with this setting.  
Example: When [White Level] is set to "75.0%", the point at which the HLG output is 75% is displayed as 100% on the spot meter.
- Refer to [Tone Mapping Characteristics for Converting HLG to ITU709 for LCD/VF] (P 245) for each characteristic. Conversion to the ITU709 color space is performed with gamma and knee adjusted such that the maximum HDR dynamic range is visible during the conversion.

### LCD RGB Gain

For adjusting the R (red), G (green) and B (blue) gain level of the LCD monitor.  
[Setting Values: +127 to ● 0 to -128]

#### ↳ Reset

Restores [LCD RGB Gain] to the default settings.

### VF RGB Gain

For adjusting the R (red), G (green) and B (blue) gain level of the viewfinder.  
[Setting Values: +127 to ● 0 to -128]

#### ↳ Reset

Restores [VF RGB Gain] to the default settings.

## Shooting Assist Item

### Focus Assist

For setting whether to add color to the contour of the focused image upon switching the image to black-and-white.

[Setting Values: On, ●Off]

#### ↳ Type

For configuring the behavior when operating the user button that is assigned with the [Focus Assist] function.

(P61 [Focus Assist Function])

- ACCU-Focus:  
Enables the Focus Assist and ACCU-Focus (forced focus) functions. The depth of field of the object becomes shallower to enable easier focusing. The ACCU-Focus function switches automatically to "Off" after about 10 seconds.
- Normal:  
Enables only the Focus Assist function. The focused area is displayed in color to enable easier focusing. Display color can be specified with [Color].

[Setting Values: ACCU-Focus, ●Normal]

#### ↳ Color

For setting the display color of the focused area when Focus Assist is activated.

[Setting Values: ●Blue, Green, Red]

### Zebra

For selecting whether to display zebra patterns at the bright areas of the subject.

Select "On" to display zebra patterns or "Off" to hide.

[Setting Values: On, ●Off]

#### ↳ Detect

For configuring the timing to detect the zebra pattern display.

- Converted ITU709:  
Performs detection after converting to the ITU709 color space.
- HLG/J-Log1:  
Performs detection before converting to the ITU709 color space.

[Setting Values: Converted ITU709, ●HLG/J-Log1]

Memo : \_\_\_\_\_

- This item is selectable only when [Color Space] is set to "J-Log1" or "HLG" and [Convert to ITU709] is set to "Cam" or "Cam + Return".

## ↳ Top

For setting the maximum luminance level for the zebra pattern display.  
[Setting Values: Over, 100%, 98%, 95% to 5% (in 5% increments)] (●80%)

## ↳ Bottom

For setting the minimum luminance level for the zebra pattern display.  
[Setting Values: 100%, 98%, 95% to 0% (in 5% increments)] (●70%)

Memo : \_\_\_\_\_

- The relation between Top and Bottom is such that Top>Bottom always holds. To maintain this relation during setting, the setting value is automatically corrected.

## Peaking Frequency

For setting the frequency bandwidth for emphasizing the outline using the [PEAKING] button.  
[Setting Values: High, ●Middle, Low]

## Histogram

For setting whether to display the histogram, which shows the distribution of different points with different levels of brightness in an image.  
[Setting Values: On, ●Off]

## ↳ Histogram Top

For selecting the maximum brightness limit for changing the histogram display color.  
[Setting Values: 5% to 110% (in 5% increments)] (● 80%)

- When [Color Space] is set to “J-Log1”

[Setting Values: -5F-stop, -4F-stop, -3F-stop(2%), -2F-stop, -1F-stop, 0F-stop(18%),  $\frac{1}{3}$ F-stop,  $\frac{2}{3}$ F-stop, 1F-stop,  $1\frac{1}{3}$ F-stop,  $1\frac{2}{3}$ F-stop, 2F-stop,  $2\frac{1}{3}$ F-stop(90%),  $2\frac{2}{3}$ F-stop, ●3F-stop,  $3\frac{1}{3}$ F-stop,  $3\frac{2}{3}$ F-stop, 4F-stop,  $4\frac{1}{3}$ F-stop,  $4\frac{2}{3}$ F-stop, 5F-stop,  $5\frac{1}{3}$ F-stop,  $5\frac{1}{2}$ F-stop]

Memo : \_\_\_\_\_

- When [Color Space] is set to “J-Log1”, a green line appears which corresponds to the “0F-stop(18%)” portion of the subject with 18% reflectance.

## ↳ Histogram Bottom

For selecting the minimum brightness limit for changing the histogram display color.  
[Setting Values: 0% to 105% (in 5% increments)] (● 20%)

- When [Color Space] is set to “J-Log1”

[Setting Values: -6F-stop, -5F-stop, -4F-stop, ●-3F-stop(2%), -2F-stop, -1F-stop, 0F-stop(18%),  $\frac{1}{3}$ F-stop,  $\frac{2}{3}$ F-stop, 1F-stop,  $1\frac{1}{3}$ F-stop,  $1\frac{2}{3}$ F-stop, 2F-stop,  $2\frac{1}{3}$ F-stop(90%),  $2\frac{2}{3}$ F-stop, 3F-stop,  $3\frac{1}{3}$ F-stop,  $3\frac{2}{3}$ F-stop, 4F-stop,  $4\frac{1}{3}$ F-stop,  $4\frac{2}{3}$ F-stop, 5F-stop,  $5\frac{1}{3}$ F-stop]

Memo : \_\_\_\_\_

- When [Color Space] is set to “J-Log1”, a green line appears which corresponds to the “0F-stop(18%)” portion of the subject with 18% reflectance.

## Marker Settings Item

For setting the marker and safety zone, which are useful in helping you determine the angle of view for the image according to the shooting purpose.  
(P169 [Marker and Safety Zone Displays (Camera Mode Only)])

Memo : \_\_\_\_\_

- During Clip Review or when in the Media mode, the markers do not appear regardless of the setting.

## Marker

For setting whether to display marker, safety zone, and center marks on the screen.  
[Setting Values: On, ●Off]

## ↳ Grid Marker

For setting whether to display a 3x3 grid on the screen.  
[Setting Values: On, ●Off]

Memo : \_\_\_\_\_

- When [Grid Marker] is set to “On”, [Aspect Ratio], [Aspect Marker], and [Safety Zone] do not function.

### ↳ Aspect Ratio

For selecting the final image aspect ratio to be used from the overall angle of view.

[Setting Values: 16:9(+4:3), 2.35:1 Top, 2.35:1 Center, 1.85:1 Top, 1.85:1 Center, ●16:9, 1.75:1, 1.66:1, 14:9, 13:9, 4:3]

Memo : \_\_\_\_\_

- When [System] → [Record Set] → [Record Format] → [SD Aspect] is set to “4:3”, this item is fixed at “4:3” and cannot be selected.  
(☞ P152 [ SD Aspect ])

### ↳ Aspect Marker

For specifying how boundary markers are to be used to indicate the parts of an image that are beyond the range of the aspect ratio selected in [Aspect Ratio].

- Line+Halftone:  
Displays the boundary using lines, and areas outside the boundary in halftone.
- Halftone:  
Displays areas outside the boundary in halftone.
- Line:  
Displays the boundary using lines.
- Off:  
Hides the boundary markers.

[Setting Values: Line+Halftone, Halftone, Line, ●Off]

Memo : \_\_\_\_\_

- When [Aspect Ratio] is set to “16:9” or “16:9(+4:3)”, this item is fixed at “Off” and cannot be selected.

### ↳ Safety Zone

For setting the percentage of area that is to be deemed as valid area (Safety Zone) within the boundary of the aspect ratio selected in [Aspect Ratio].

[Setting Values: 95%, 93%, 90%, 88%, 80%, ●Off]

### ↳ Center Mark

For specifying whether to display a mark to indicate the screen center within the aspect ratio selected in [Aspect Ratio].

[Setting Values: ●On, Off]

## Display Type Item

This menu is used to set the displays on the LCD monitor and viewfinder screen.

### Battery

For setting the display of the remaining battery power on the LCD monitor and viewfinder screen.

- Time:  
Displays the remaining battery power in minutes. (min)
- Capacity%:  
Displays the remaining battery power in percentage. (%)
- Voltage:  
Displays the current battery voltage in units of 0.1 V. (V)

[Setting Values: ●Time, Capacity%, Voltage]

Memo : \_\_\_\_\_

- The battery mark that appears before the “Time”, “Capacity%” or “Voltage” value changes according to the remaining battery power.

In addition, the plug mark is added during charging.

		: 10 % and below
		: 11 % to 30 %
		: 31 % to 70 %
		: 71 % to 100 %

- When the remaining battery power is low, “RES” instead of the value is displayed.  
Replace the battery as soon as possible.
- The remaining battery power and remaining time are intended as reference values for the shooting duration.
- The time, capacity or voltage will not be displayed during charging.

### TC/UB

For specifying whether to display the time code (TC) or user’s bit (UB) rate in the display on the LCD monitor and viewfinder screen.

[Setting Values: UB, ●TC]

### Zoom

For setting the display method of the zoom position.

- Number:  
Displays the zoom position in numbers.
- Bar:  
Displays the zoom position in a bar.

[Setting Values: Number, ●Bar]



## Focus

For setting the display method of the approximate distance to the subject in focus.

- **Feet:**  
Displays the distance in feet.
- **Meter:**  
Displays the distance in meters.

[Setting Values: Feet, ●Meter]

## ND Filter

For specifying how the filter position is to be displayed.

- **Normal + Assist:**  
Displays the current filter position.  
If the ND filter setting is inappropriate, the appropriate ND filter to select will appear blinking.
- **Normal:**  
Displays the current filter position.

[Setting Values: Normal + Assist, ●Normal]

## Shutter

For setting the shutter display to be displayed on the LCD monitor and viewfinder screen.

- **DEG:**  
Displays the shutter speed in degrees in the same way as film cameras.
- **SEC:**  
Displays the shutter speed in seconds.

[Setting Values: DEG, ●SEC]

Memo : \_\_\_\_\_

- “DEG” is selectable only when [A]Frame Rate] is set to “24p” or “25p”.  
When [A]Frame Rate] is set to other values, the shutter display setting is fixed at “SEC” and cannot be selected.  
(P151 [A]Frame Rate/ [EXT]Frame Rate)

## Gain

For setting the gain display to be displayed on the LCD monitor and viewfinder screen.

- **ISO:**  
Displays the gain as ISO sensitivity.
- **dB:**  
Displays the gain in dB (decibel).

[Setting Values: ISO, ●dB]

Memo : \_\_\_\_\_

- This item cannot be configured when [Color Space] is set to “HLG”.

## Display On/Off Item

For setting whether to turn on or off the display of an item on the LCD monitor and viewfinder screen.

**Battery, Clip Info, High-Speed, Media Status, Rec Trigger, TC/UB, Media Remain, Record Format, Video Format, Guide, GPS <sup>550</sup> SPC, Return over IP, Live Streaming, Network, Date, Time, Operation Lock, Zoom, Focus, Zebra, Focus Assist, Color Space, Black Toe, ND Filter, OIS, Face Detection, Infrared, AE Level, Iris, Shutter, Gain, White Balance, Audio Meter, Position Bar, Camera Angle[Tagging] SPC, ODK[Tagging] SPC**

For configuring whether to display or hide an item.  
[Setting Values: ●On, Off]

Memo : \_\_\_\_\_

- This may not be selectable depending on the operating mode and status.

# A/V Set Menu

Menu screen for video output and audio.

## Video Set...

For specifying video output-related settings.  
( P130 [Video Set Item])

## Audio Set...

For specifying audio-related settings.  
( P132 [Audio Set Item])

## Video Set Item

### SDI OUT

For configuring video output from the [SDI OUT] terminal.  
[Setting Values: On, ●Off]

Memo : \_\_\_\_\_

- When a resolution with no SDI output is selected, the setting is fixed at “Off”.
- When “4K EXT (SSD)” is selected for the [System] item, video images are not output from the [SDI OUT] terminal.

### ↳ Character

For configuring whether to show the display and menu on the [SDI OUT] terminal.  
[Setting Values: On, ●Off]

### ↳ Resolution

For selecting the resolution of video output from the [SDI OUT] terminal according to the monitor to be connected.  
[Setting Values: 1080psF, ●1080p, 1080i, 720p, 576i, 480i, 480i (2:3pd)]

Memo : \_\_\_\_\_

- The selectable options vary according to the [System] → [Record Set] → [Record Format] → [System]/[Resolution] setting.
- Cross conversion output is not possible.
- When [A/V Set] → [Video Set] → [SDI OUT] → [Resolution] is set to “1080p”, configuring [System] → [GPS] to “On” changes the setting to “1080p”. **550** **SPC**

### ↳ 3G-SDI Mapping

For configuring the mode of mapping for signals output from the [SDI OUT] terminal.  
[Setting Values: Level B, ●Level A]

Memo : \_\_\_\_\_

- SDI output is configurable only when the setting is set to “1080p”.
- When [SDI OUT] is configured to “Off”, this item cannot be configured.

### ↳ Rec Trigger

For configuring whether to superimpose trigger signals on the [SDI OUT] terminal in tandem with the [REC] button.

If “Type-A” or “Type-B” is specified, it is possible to record on a device equipped with SDI record trigger in tandem with the operation of the [REC] button. When a compatible device is connected, recording/stop control signals are output in tandem with the operation of the [REC] button.

The record trigger output status to the connected device is indicated by REC → /STBY → on the display screen.  
[Setting Values: Type-A, Type-B, ●Off]

Memo : \_\_\_\_\_

- If “Type-A” does not work, it may operate in the “Type-B” setting, but the user’s bit to the connected device will not be correctly output.
- Even if REC → /STBY → is displayed on the display screen, the compatible device may not necessarily be recording.
- This item can be configured when [SDI OUT] is configured to “On” and [Rec Mode] is configured to “Normal”, “Pre Rec” or “Clip Continuous”.
- Set to “Off” if connecting to a device that does not support record trigger.

## HDMI OUT

For configuring video output from the [HDMI] terminal.

[Setting Values: On, ●Off]

Memo : \_\_\_\_\_

- Monitor and menu displays are not output from the [HDMI] terminal.

## ↳ Resolution

For selecting the resolution of video output from the [HDMI] terminal according to the monitor to be connected.

[Setting Values: 2160/60p, 2160/50p, 2160/30p, 2160/25p, 2160/24p, 1080/60p, 1080/50p, 1080/30p, 1080/25p, 1080/24p, 1080p, ●1080i, 720p, 576p, 576i, 480p, 480i, 480p(2:3pd)]

Memo : \_\_\_\_\_

- The selectable options vary according to the settings in [System] → [Record Set] → [Record Format] → [System] and [A]Resolution/[EXT]Resolution].
- Cross conversion output is not possible.
- When in the Camera mode, selecting “SD” for [System] → [Record Set] → [Record Format] → [System] fixes the resolution at “480p” or “576p”.

## ↳ Color

For setting the color format of HDMI signals.

[Setting Values: RGB, ●Auto]

Memo : \_\_\_\_\_

- This item can be configured when [HDMI OUT] is set to a setting other than “Off”.

## ↳ Colorimetry

For configuring the colorimetry of the HDMI signal when [Camera Process] → [Color Space] → [Colorimetry] is set to “ITU2020”.

- ITU2020:  
Outputs using the colorimetry of ITU2020 regardless of the device that is connected via HDMI.
- ITU709:  
Outputs using the colorimetry of ITU709 regardless of the device that is connected via HDMI.
- Auto:  
Switches the colorimetry automatically according to the device that is connected via HDMI.

[Setting Values: ITU2020, ITU709, ●Auto]

Memo : \_\_\_\_\_

- This item can be configured when [HDMI OUT] is set to a setting other than “Off”.
- This item can be configured when [HDMI Color] is set to “Auto”.
- This item cannot be configured when [Camera Process] → [Color Space] → [Colorimetry] is set to a setting other than “ITU2020”.

## ↳ Enhance

For setting the color range of HDMI signals. When connecting to a PC monitor, set this to “On”.

[Setting Values: On, ●Off]

Memo : \_\_\_\_\_

- This item can be configured when [HDMI OUT] is set to a setting other than “Off”.

### ↳ Rec Trigger

For configuring whether to superimpose trigger signals on the [HDMI] out terminal in tandem with the [REC] button.

If "On" is specified, it is possible to record on a device equipped with HDMI record trigger in tandem with the operation of the [REC] button. When a compatible device is connected, recording/stop control signals are output in tandem with the operation of the [REC] button.

The HDMI record trigger output status to the connected device is indicated by REC →/STBY → on the display screen.

[Setting Values: On, ●Off]

Memo : \_\_\_\_\_

- Even if REC →/STBY → is displayed on the display screen, the compatible device may not necessarily be recording.
- This item can be configured when [HDMI OUT] is set to a value other than "Off", and [Rec Mode] is set to "Normal", "Pre Rec" or "Clip Continuous".
- Set to "Off" if connecting to a device that does not support record trigger.

### ↳ TC

For setting whether to superimpose time code to the [HDMI] terminal.

[Setting Values: On, ●Off]

Memo : \_\_\_\_\_

- This item can be configured when [HDMI OUT] is set to a setting other than "Off".
- Set to "Off" if connecting to a device that does not support HDMI TC.

## Audio Set Item

### Input1 Mic Ref.

For setting the reference input level when the [INPUT1] selection switch is set to "MIC" or "MIC +48V".

[Setting Values: -62dB, -56dB, ●-50dB, -44dB, -38dB, -32dB]

### Input2 Mic Ref.

For setting the reference input level when the [INPUT2] selection switch is set to "MIC" or "MIC +48V".

[Setting Values: -62dB, -56dB, ●-50dB, -44dB, -38dB, -32dB]

### Int. Mic Gain

For setting the sensitivity of the built-in microphone.

[Setting Values: 12 dB, 6 dB, ●0dB]

### AUX Gain

For setting the sensitivity of the [AUX] terminal input.

[Setting Values: 12 dB, 6 dB, ●0dB]

### Ref. Level

For setting the recording reference level. (Applies to both [CH1/CH2].)

[Setting Values: -12dB, -18dB, ●-20dB]

### Limiter

For setting the limiter operation.

- -9dBFS:
  - Sets "-9dBFS" to the maximum recording level.
- -6dBFS:
  - Sets "-6dBFS" to the maximum recording level.
- Off:
  - Depending on the settings of the [CH1/CH2 AUTO/MANUAL] selection switches, the operation may be different as described below.
    - The limiter does not function when "MANUAL" is set.
    - The limiter functions at -6dBFS when "AUTO" is set.

[Setting Values: -9dBFS, ●-6dBFS, Off]

**AGC Response**↳ **Attack Time**

Sets the time to activate the limiter.  
[Setting Values: Fast, ●Middle, Slow]

↳ **Decay Time**

Sets the time to deactivate the limiter operation.  
[Setting Values: Fast, ●Middle, Slow]

**AGC Mode**

For setting whether to link the limiter operation of [CH1] and [CH2].

Select "Link" to link or "Separate" to separate.  
[Setting Values: Link, ●Separate]

Memo : \_\_\_\_\_

- Enabled only when both the [AUX] input terminal and [INPUT1/INPUT2] input terminal are set to "LINE" or "MIC", and CH1/CH2 of the [CH1/CH2 AUTO/MANUAL] switch is set to "AUTO".

**XLR Manual Level**

For setting whether to link manual audio adjustment operation between [INPUT1] and [INPUT2] terminals.

Select "Link" to link or "Separate" to separate.

When this item is set to "Link", adjust the recording level using the [CH1] recording level adjustment knob.

[Setting Values: Link, ●Separate]

Memo : \_\_\_\_\_

- Enabled only when both the [INPUT1/INPUT2] input terminals are set to "LINE" or "MIC", and both [CH1]/[CH2] of the [CH1/CH2 AUTO/MANUAL] selection switches are set to "MANUAL".
- When this item is set to "Link", [CH2] recording level adjustment knob is disabled.

**Int. Mic Separation**

For setting the enhancement level of the stereo effect of the built-in microphone.

- On:  
Enhances the stereo effect.
- Off:  
Does not enhance the stereo effect.

[Setting Values: ●On, Off]

Memo : \_\_\_\_\_

- Both [CH1] and [CH2] selection switches are set to "INT".
- When [Int. Mic Separation] is set to "On", a  icon is displayed on the status screen (audio input) while the function is operating.

**Test Tone**

For specifying whether to output the audio test signals (1 kHz) during color bar output.

[Setting Values: On, ●Off]

**INPUT1/2 Wind Cut**

For selecting whether to cut the low frequencies of the audio input signals (low-cut) when the [INPUT1/INPUT2] switch is set to "MIC" or "MIC+48V".

Set this item to reduce wind noise from the microphone.

- Both:  
Enables low-cut on both the [INPUT1] and [INPUT2] terminals.
- INPUT2:  
Enables low-cut on the audio of the [INPUT2] terminal only.
- INPUT1:  
Enables low-cut on the audio of the [INPUT1] terminal only.
- Off:  
Disables low-cut.

[Setting Values: Both, INPUT2, INPUT1, ●Off]

**Int. Mic Wind Cut**

For selecting whether to cut the low frequencies of the audio input signals (low-cut) from the built-in microphone. Set this item to "On" to reduce wind noise from the microphone.

[Setting Values: On, ●Off]

**Equalizer**

You can correct the characteristic and enhance the sound of the connected microphone using this equalizer setting.  
 For setting the audio frequency from a 5-band equalizer.

- Frequency:  
100Hz, 330Hz, 1kHz, 3.3kHz, 10kHz
- Variable level:  
± 6dB (1dB step)

Memo : \_\_\_\_\_

- Audio will be recorded in the characteristic set in the equalizer.
- Set all bands to "0 dB" to bypass the equalizer.
- When the equalizer level is set to the + side, the audio may be distorted. In this case, reduce the recording level in Manual mode.
- If the values of multiple frequencies are changed, the specified levels and the actual levels may be different due to interference between the frequency bands.
- This function is enabled only when both [INPUT1/2 Wind Cut] and [Int. Mic Wind Cut] are set to "Off".

**Monitor**

For setting the audio sound of the [ ] terminal to stereo or mixed sound when the [MONITOR] selection switch on the LCD monitor is set to "BOTH".

- Mix:  
Outputs mixed sound (mixed sound of CH1 and CH2) to both L and R.
- Stereo:  
Outputs stereo sound (outputs audio sound of CH1 to L, and CH2 to R).

[Setting Values: ●Mix, Stereo]

Memo : \_\_\_\_\_

- If both CH1 and CH2 are built-in microphones, stereo sound is output from the [ ] terminal regardless of the [Monitor] setting.

**IFB/RET Monitor...**

↳ **CH1(/2)**

For configuring the output from the [ ] terminal during IFB Return over IP of each channel.

- Auto:  
Outputs upon mixing the IFB/Return over IP audio with the microphone audio when IFB/Return over IP audio input is detected. Outputs only the microphone audio when IFB/Return over IP audio input is not detected.
- IFB/RET Only:  
Outputs only the IFB/Return over IP audio at all times.
- Off:  
IFB/Return over IP audio is not output.

[Setting Values: ●Auto, IFB/RET Only, Off]

Memo : \_\_\_\_\_

- To enable different settings for CH1 and CH2 of [IFB/RET Monitor], set [Monitor] to "Stereo".

**Alarm Level**

For selecting whether to turn on the warning tone as well as setting the volume.

The warning tone is output from the monitor speaker or [ ] terminal.

[Setting Values: ●High, Middle, Low, Off]

**Audio On FULL AUTO**

For setting whether to enable Auto for audio when the [FULL AUTO] switch is set to "ON".

- Auto:  
Sets audio recording mode to the auto mode.
- SW Set:  
Sets the audio recording mode following the [CH1/CH2 AUTO/MANUAL] selection switch setting.

[Setting Values: ●Auto, SW Set]

# Network Menu

For specifying network-related settings.  
The display of the software keyboard for input varies according to the item you are setting.

## Connection Setup...

For configuring the network connection settings. A [Wizard] screen will appear according to the mode of connection. Follow the instructions to perform the setting.  
The preconfigured settings can be loaded, saved or deleted.

( P136 [Connection Setup Item] )

Memo : \_\_\_\_\_

- Users cannot access this menu in the following cases.
  - During manual FTP transfer
  - During live streaming
  - Return over IP in Progress

## Live Streaming...

For configuring settings for distributing live video images and audio.

( P137 [Live Streaming Item] )

Memo : \_\_\_\_\_

- Users cannot access this menu in the following cases.
  - When [Record Format] → [System] is set to a setting other than “HD” or “SD”
  - During FTP transfer
  - When [Record Format] → [Frame Rate] is set to “24p”

## Return over IP...

For configuring settings related to Return over IP. This function allows video and audio to be received via the network.

( P139 [Return over IP Item] )

Memo : \_\_\_\_\_

- Users cannot access this menu in the following cases.
  - When [Record Format] → [System] is set to a setting other than “HD” or “SD”
  - When [Record Format] → [Frame Rate] is set to “24p”
  - When [Overlay Settings] → [Overlay Function] is set to “Enable” **550 SPC**
  - When [Record Set] → [Time Stamp] is set to “On”

## Web...

For setting the functions that make use of the web browser.

( P141 [Web Item] )

## Metadata Server...

For registering the FTP server for importing the metadata and the path of the file to be imported. Up to 4 settings can be registered.

( P142 [Metadata Server Item] )

## Upload Settings...

For configuring the method for uploading to the FTP server as well as the server and directory for uploading the clip recorded in the media to the FTP server.

( P142 [Upload Settings Item] )

## Import Metadata

- For importing metadata from the FTP server.
  - Metadata loaded by the setup files (“User File”/ “All File”) will be deleted.
- ( P180 [Importing Metadata] )

Memo : \_\_\_\_\_

- This option is not selectable if the network connection is not established.
- This option is not selectable while using the network.

## Zero Config

For allowing this camera recorder to be detected automatically by external devices (such as switchers) connected to the same LAN. Connection can be established via one link from the menu of the external device.

Memo : \_\_\_\_\_

- The Zero Config function is not equipped with the function to change the settings of the camera recorder.

### ↳ Announcement

For configuring the method of connection from an external device during automatic detection of this camera recorder.

[Setting Values: ●On, Off]

### ↳ Hostname Prefix

Part of the host name can be changed. It will appear in the format of "XXXX-YYYY.local" on the Status screen (network).

XXXX : Character string (maximum 8 characters) configured in [Hostname Prefix]

YYYY : Serial number of this camera recorder

Memo : \_\_\_\_\_

- When [Announcement] is configured to "Off", this item does not appear on the status screen (Connection Setup).

## Reset Network

Restores all items in the [Network] menu to their default settings.

## Connection Setup Item

### Wizard

Displays a [Wizard] screen for connecting to the network.

Follow the instructions on the screen.

## Setup File

### ↳ Load

Loads the settings on the [Wizard] screen.

(☞ P202 [Reading the Connection Settings File])

### ↳ Store

Saves the settings on the [Wizard] screen.

(☞ P201 [Saving the Connection Settings File])

### ↳ Delete

Deletes the saved settings.

(☞ P203 [Deleting Connection Settings])

## FTP Proxy...

For setting the FTP proxy.

### ↳ Type

Select the type of FTP proxy.

[Setting Values: ●No Proxy, HTTP]

### ↳ Server

Set the FTP proxy server name.

Memo : \_\_\_\_\_

- Enter the name using the onscreen keyboard.
- You can enter characters not more than 127 bytes using single-byte alphanumeric characters (a to z, 0 to 9), single-byte hyphen ("-") or dot (".").
- When [Type] is set to "No Proxy", changes cannot be made.

### ↳ Port

Set the FTP proxy port number.

Memo : \_\_\_\_\_

- Enter the name using the onscreen keyboard.
- Enter an integer between 1 and 65535.

## APN

For specifying APN (Access Point Name).

\* This item is grayed out and cannot be selected if APN cannot be set for the adapter attached.

Caution : \_\_\_\_\_

- The APN setting is written into the cellular adapter, not this camera recorder. Setting a wrong APN may result in communication failure or expensive bills from the telecommunications company. Set the APN correctly.  
(☞ P180 [Cellular adapter connection ("USB"- "Cellular")])



## Live Streaming Item

### Live Streaming

Starts live distribution when “On” is selected.

[Setting Values: On, ●Off]

Memo : \_\_\_\_\_

- “On” cannot be selected if streaming is not possible with the selected resolution, frame rate and bitrate combination.
- “On” cannot be selected if connection of the selected network is not established.
- “On” cannot be selected when FTP is running.
- Live streaming switches to “Off” when the power is turned off.

### ↳ Auto Restart

When the network is reconnected after disconnection, live streaming will resume automatically.

- On:  
Once the network is reconnected, live streaming resumes automatically.
- Off:  
Live streaming does not resume automatically even when the network is reconnected.

[Setting Values: On, ●Off]

Memo : \_\_\_\_\_

- When the power of the camera is turned off, regardless of the settings in [Auto Restart], live streaming does not begin automatically even when power is turned on again and network connection is established.
- The setting cannot be changed during live streaming (when live streaming is configured to “On”).

### Server

For selecting the server for live streaming.

[Setting Values: ●Server1, Server2, Server3, Server4]

Memo : \_\_\_\_\_

- The setting cannot be changed during live streaming (when [Live Streaming] set to “On”).

### ↳ Streaming Server

For setting the server for live streaming.

Memo : \_\_\_\_\_

- The setting cannot be changed during live streaming (when [Live Streaming] set to “On”).

### ↳ Server1, Server2, Server3, Server4

- \* The name that is set in [Alias] is displayed individually.

#### ■ Alias

For setting a name to distinguish the settings of this camera.

The name set in this item will be displayed in the [Server] options.

- \*1 The default value is “Server1/Server2/Server3/Server4”.
- \*2 You can enter up to 31 characters and ASCII characters.

#### ■ Type

For configuring the system for transferring video and audio to be distributed.

[Setting Values: ●MPEG2-TS/UDP, MPEG2-TS/TCP, MPEG2-TS/RTPRTSP/RTP, ZIXI, RTMP]

#### 550

[Setting Values: ●MPEG2-TS/UDP, MPEG2-TS/TCP, MPEG2-TS/RTP, RTSP/RTP, RTMP] **500**

Memo : \_\_\_\_\_

- Use reception devices that are compatible with the respective transfer systems.
- To use the “ZIXI” setting, a dedicated server is needed separately. **550**
- The following items that can be set vary depending on the setting of this item.

#### ■ Destination Address

For setting details such as the host name and the IP address of the live distribution destination.

- \* Enter not more than 127 characters using single-byte alphanumeric characters (a to z, 0 to 9), single-byte hyphen [-], or dot [.]

**■ Destination URL**

For entering the URL of the live distribution destination beginning with "rtmp://".

There is no default value (blank).

- \* You can enter up to 191 characters and ASCII characters.

Memo : \_\_\_\_\_

- This item is selectable only when [Type] is set to "RTMP".

**■ Destination Port**

Enter the network port number of the live distribution destination using an integer between 1 and 65535.

When [Type] is set to "MPEG2-TS/UDP", "MPEG2-TS/TCP" or "MPEG2-TS/RTP", the default value is "6504". If "ZIXI" is set, the default value is "2088".

Memo : \_\_\_\_\_

- When [Type] is set to "MPEG2-TS/RTP", only even numbers from 2 to 65530 can be specified for the port number.
- When [Type] is set to "MPEG2-TS/RTP" and [SMPTE 2022-1 FEC] is set to "On", N+2 and N+4 port numbers are also used in addition to the specified port number (N).

**■ Stream ID 550**

For setting the registered stream ID of the live distribution destination.

The default value varies with the product model.

- \* Enter not more than 63 characters.

Memo : \_\_\_\_\_

- This item is selectable only when [Type] is set to "ZIXI".

**■ Stream Key**

Enter the stream key specified at the live transmission destination.

There is no default value (blank).

- \* Enter not more than 127 characters.

Memo : \_\_\_\_\_

- This item is selectable only when [Type] is set to "RTMP".

**■ Username**

For setting the user name.

The default value is "JVC".

- \* Enter not more than 31 characters.

Memo : \_\_\_\_\_

- This item is selectable only when [Type] is set to "RTSP/RTP".

**■ Password**

For setting the [Stream ID] password.

For ZIXI, there is no default value (blank).

For RTSP/RTP, a random alphanumeric value that varies with each model is assigned as the default value.

- \* Enter not more than 127 characters. Enter not more than 31 characters for RTSP/RTP setting.

**■ Latency 550**

For setting the latency mode.

[Setting Values: High, Medium, Low, Min]

Memo : \_\_\_\_\_

- This item is selectable only when [Type] is set to "ZIXI".

**■ Adaptive Bit Rate 550**

If "On" is selected, the bit rate setting value of live streaming is set to maximum limit, and the bit rate is changed automatically according to changes in the network bandwidth.

[Setting Values: On, Off]

Memo : \_\_\_\_\_

- [Adaptive Bit Rate] can be configured when [Type] is configured to "ZIXI".

- \* The bit rate is displayed on the status screen only when "On" is set.

**■ SMPTE 2022-1 FEC**

Set to "On" to use FEC (Forward Error Correction).

A transmission system that recovers the missing packets in the decoding process without having to retransmit the missing packets.

[Setting Values: On, Off]

- \* The decoder must be compatible with SMPTE 2022-1.

Memo : \_\_\_\_\_

- This item is selectable only when [Type] is set to "MPEG2-TS/RTP".

## ■ FEC Matrix

For setting the amount of FEC (Forward Error Correction) overhead for configuring SMPTE2022-1.

( P209 [Setting the FEC Matrix] )

Memo : \_\_\_\_\_

- This item is selectable only when [SMPTE 2022-1 FEC] is set to "On".

## Resolution

For setting the resolution of the video image during live distribution.

The available options vary according to the settings for [**A**Resolution] and [**A**Frame Rate] under [Record Format].

<b>A</b> Resolution	Setting Value
1920x1080 1440x1080	1920x1080, 1280x720, 640x360, 720x480, 720x576
1280x720	1280x720, 640x360
720x480 (U model)	720x480
720x576 (E model)	720x576

Memo : \_\_\_\_\_

- The setting cannot be changed during live streaming (when [Live Streaming] set to "On").
- The Aspect Ratio for the live streaming image is fixed to "16:9".

## Frame Rate

For setting the frame rate of the video image during live distribution.

The options vary according to the settings of [Live Streaming Set] → [Resolution] and the [**A**Frame Rate] settings under [Record Format].

<b>A</b> Frame Rate	Setting Value
60p, 60i	60p, 60i, 30p
50p, 50i	50p, 50i, 25p
30p	30p
25p	25p

Memo : \_\_\_\_\_

- The setting cannot be changed during live streaming (when live streaming is configured to "On").

## Bit Rate

For setting the encode bitrate of the video image during live distribution.

The selectable options vary according to the settings in [Live Streaming Set] → [Resolution] and [Bit Rate].

For details on the settings, please refer to [Distributable [Record Format] and [Live Streaming Set] Combinations] ( P 206).

Memo : \_\_\_\_\_

- The setting cannot be changed during live streaming (when [Live Streaming] set to "On").
- Depending on the type of network adapter used and the connection, images and audio sound during live streaming may be choppy.

## Return over IP Item

### Function 550

For configuring the Return over IP function to Enable or Disable when in the QuickTime(MPEG2) or MXF(MPEG2) mode.

[Setting Values: Enable, ●Disable]

Memo : \_\_\_\_\_

- Configure this item when "QuickTime(MPEG2)" or "MXF(MPEG2)" is selected for [System] → [Record Set] → [Record Format] → [**A**Format]. The live streaming images may turn out different depending on whether this item is configured to "Enable" or "Disable". It is recommended that this item be configured to "Disable" if only live streaming is to be used.
- When this is configured to "Enable" and [Camera Process] → [Color Space] is configured to "J-Log1" or "HLG", live streaming settings will be as follows.
  - [Color Space] "ITU709"
  - [Gamma] "Standard"
  - [Knee]"Manual"/[Level]"95.0%"
  - [Color Matrix] "Standard"

### Return over IP

For configuring Return over IP to On/Off.

[Setting Values: On, ●Off]

Memo : \_\_\_\_\_

- This is fixed at "Off" when [Return over IP] → [Function] is set to "Disable". 550

**Server**

For selecting the source server for sending out Return over IP audio/video.

[Setting Values: ●Server1, Server2, Server3, Server4]

Memo : \_\_\_\_\_

- The setting cannot be changed while Return over IP is operating (when [Return over IP] is set to "On").
- When [Return over IP] → [Function] is configured to "Disable", this item cannot be changed. **550**

**↳ Return Server**

For configuring the source server for sending out Return over IP audio/video.

Memo : \_\_\_\_\_

- The setting cannot be changed while Return over IP is operating (when [Return over IP] is set to "On").

**↳ Server1, Server2, Server3, Server4**

\* The name that is set in [Alias] is displayed individually.

**■ Alias**

For setting a name to distinguish the settings of this camera.

The name set in this item will be displayed in the [Server] options.

- \*1 The default value is "Server1/Server2/Server3/Server4".
- \*2 You can enter up to 31 characters and ASCII characters.

**■ Type**

For configuring the system for transferring video and audio to be distributed.

[Setting Values: ●RTSP/RTP, ZIXI, Iccast] **550**

[Setting Values: ●RTSP/RTP, Iccast] **500**

Memo : \_\_\_\_\_

- Operates as IFB when the setting is configured to "Iccast".
- Use transmission devices that are compatible with the respective transfer systems.
- To use the "ZIXI" setting, a dedicated server is needed separately.
- The following items that can be set vary depending on the setting of this item.

**■ Protocol**

For configuring the protocol of the video/audio source server to be connected.

[Setting Values: ●UDP, TCP]

Memo : \_\_\_\_\_

- This item is selectable only when [Type] is set to "RTSP/RTP".

**■ Source Address**

For configuring details such as the host name and IP address of the video/audio transmission source. There is no default value (blank).

\* You can enter up to 191 characters and ASCII characters.

**■ Source Port**

Enter the network port number of the video/audio transmission source using an integer between 1 and 65535.

The default value is "554" when [Type] is set to "RTSP/RTP", "2077" when it is set to "ZIXI", and "5000" when it is set to Iccast.

Memo : \_\_\_\_\_

- When [Type] is set to "RTSP/RTP", only even numbers from 2 to 65530 can be specified for the port number.

**■ Stream ID**

For configuring the stream ID registered on the video/audio transmission source.

There is no default value (blank).

\* Enter not more than 63 characters.

Memo : \_\_\_\_\_

- This item is available for setting when [Type] is set to "RTSP/RTP" or "ZIXI".

**■ Username**

For setting the user name.

There is no default value (blank).

\* Enter not more than 63 characters.

Memo : \_\_\_\_\_

- This item is selectable only when [Type] is set to "RTSP/RTP".

**■ Password**

For setting the password.

There is no default value (blank).

- \* You can enter up to 31 characters when [Type] is set to "RTSP/RTP".
- \* You can enter up to 127 characters when [Type] is set to "ZIXI".

Memo : \_\_\_\_\_

- This item is available for setting when [Type] is set to "RTSP/RTP" or "ZIXI".

**■ Name 550**

For configuring the name.

The default value is "HC550".

- \* Enter not more than 31 characters.

Memo : \_\_\_\_\_

- This item is selectable only when [Type] is set to "ZIXI".

**■ Latency 550**

For setting the latency mode.

[Setting Values: Medium, ●Min, Off]

Memo : \_\_\_\_\_

- This item is selectable only when [Type] is set to "ZIXI".

**■ Mountpoint**

Enter the mountpoint (character string for identifying a stream) for streaming servers that support multiple streams.

There is no default value (blank).

- \* Enter not more than 63 characters.

Memo : \_\_\_\_\_

- This item is selectable only when [Type] is set to "Icecast".

**| Web Item****Web Access**

To access via a web browser, set to "On".

[Setting Values: ●On, Off]

**Camera Name**

For setting the name to be displayed on the web browser. Enter not more than 8 characters using the software keyboard.

(Default value: HC550 550, HC500 500)

**Username**

For setting the user name. Enter not more than 31 characters using the software keyboard.

(Default value: jvc)

**Password**

Changes the password for accessing via a web browser.

The current password is displayed. Enter a new password directly.

Enter not more than 31 characters using the software keyboard.

(Default value: random alphanumeric value that varies with each model)

**Port**

For configuring the port number during access to a web page from an external source.

Memo : \_\_\_\_\_

- Enter the name using the software keyboard.
- Enter an integer between 1 and 65535. (Default value: 80)
- To configure the setting to a number other than the default value, specify the number of an unused port.
- For more details, please consult the administrator of the network in use.

## Metadata Server Item

### Meta-FTP1, Meta-FTP2, Meta-FTP3, Meta-FTP4

- \* The name that is set in [Alias] is displayed individually.
  - **Alias**  
For setting a name to distinguish the settings of this camera.  
The name set in this item will be displayed in the [Import Metadata] options.
  - \* Enter not more than 31 characters.
  - **Protocol**  
For setting the protocol of the FTP server to be connected.
  - **FTP:**  
Protocol that does not encrypt the incoming and outgoing data.
  - **SFTP:**  
Protocol that encrypts incoming and outgoing data using SSH.
  - **FTPS:**  
Protocol that encrypts incoming and outgoing data using SSL or TLS. It uses an implicit mode (starts encrypted communication once connection starts).
  - **FTPES:**  
Protocol that encrypts incoming and outgoing data using SSL or TLS. It uses an explicit mode (starts encrypted communication after permission is granted).
- [Setting Values: ●FTP, SFTP, FTPS, FTPES]
- **Server**  
For setting the server name ("mystation.com", etc.) or the IP address ("192.168.0.1", etc.) of the FTP server.
  - \* Enter not more than 127 characters using single-byte alphanumeric characters (a to z, 0 to 9), single-byte hyphen [-], or dot [.]
  - **Port**  
Enter the FTP server port number to use using an integer between 1 and 65535.  
The default value varies with the protocol setting. (FTP: 21, SFTP: 22, FTPS: 990, FTPES: 21)
  - **File Path**  
Enter the path name for the metadata file ("/pub/meta.xml", "/home/user/meta2.xml", etc.)
  - Enter not more than 127 characters.
  - **Username**  
Enter the user name for connecting to the FTP server.
  - \* Enter not more than 31 characters.

- **Password**  
Enter the password for connecting to the FTP server.

\* Enter not more than 31 characters.

- **PASV Mode**  
For setting whether to set the communication mode used for file transfer to the passive mode.  
Set to "On" if the camera is inside a firewall, and a connection from the FTP server to the camera cannot be established.  
[Setting Values: On, ●Off]

Memo : \_\_\_\_\_

- When [Protocol] is set to "SFTP", this item appears as "---" and cannot be selected.

## Upload Settings Item

### Upload

For configuring the method for uploading to the FTP server.

- **Auto:**  
Select this option for automatic FTP transfer. FTP transfer starts when [Auto Upload] is configured to "On".
- **Manual:**  
Select this option for manual FTP transfer from the Media mode.

[Setting Values: ●Auto, Manual]

### Auto Upload

When [Upload] is configured to "Auto", FTP transfer starts automatically when the setting is configured to "On".

[Setting Values: On, ●Off]

Memo : \_\_\_\_\_

- This is fixed at "Off" when [System] is set to "High-Speed".
- Configuring [Auto Upload] to "On" disables configuration of all the settings under the Upload Settings item.

### ↳ Slot

For selecting the recording media slot to enable automatic upload.

[Setting Values: ●A, B]

Memo : \_\_\_\_\_

- This is fixed at "EXT" when [System] is set to "4K EXT (SSD)".

## ↳ Cellular

For configuring whether to enable connection via a USB cellular adapter.

[Setting Values: Enable, ●Disable]

## ↳ Server

For configuring the server for uploading to the FTP server.

[Setting Values: ●Clip-FTP1, Clip-FTP2, Clip-FTP3, Clip-FTP4]

## Clip Server

### ↳ Clip-FTP1, Clip-FTP2, Clip-FTP3, Clip-FTP4

\* The name that is set in [Alias] is displayed individually.

#### ■ Alias

For setting a name to distinguish the settings of this camera.

The name set in this item will appear on the [FTP Upload] action screen of the thumbnail display.

\* Enter not more than 31 characters.

#### ■ Protocol

For setting the protocol of the FTP server to be connected.

- FTP:  
Protocol that does not encrypt the incoming and outgoing data.
- SFTP:  
Protocol that encrypts incoming and outgoing data using SSH.
- FTPS:  
Protocol that encrypts incoming and outgoing data using SSL or TLS. It uses an implicit mode (starts encrypted communication once connection starts).
- FTPES:  
Protocol that encrypts incoming and outgoing data using SSL or TLS. It uses an explicit mode (starts encrypted communication after permission is granted).
- ZIXI:  
Enables stable transmission by reducing jitter and packet loss significantly through communicating via a relay server.

[Setting Values: ●FTP, SFTP, FTPS, FTPES, ZIXI] **550**

[Setting Values: ●FTP, SFTP, FTPS, FTPES] **500**

Memo : \_\_\_\_\_

- To use the "ZIXI" setting, a dedicated server is needed separately.
- If "ZIXI" is set, the resume function is enabled.

#### ■ Server

For setting the server name ("mystation.com", etc.) or the IP address ("192.168.0.1", etc.) of the FTP server.

\* Enter not more than 127 characters using single-byte alphanumeric characters (a to z, 0 to 9), single-byte hyphen [-], or dot [.]

#### ■ Port

Enter the FTP server port number to use using an integer between 1 and 65535.

The default value varies with the protocol setting. (FTP: 21, SFTP: 22, FTPS: 990, FTPES: 21, ZIXI: 2088)

#### ■ Dir. Path

Enter the path name for the directory to upload to ("/pub", "/home/user", etc.)

\* Enter not more than 127 characters.

#### ■ Username

Enter the user name for connecting to the FTP server.

\* Enter not more than 31 characters.

#### ■ Stream ID **550**

For configuring the stream ID that is registered at the distribution destination.

The default value varies with the product model.

\* Enter not more than 63 characters.

Memo : \_\_\_\_\_

- This item is selectable only when [Type] is set to "ZIXI".

#### ■ Password

Enter the password for connecting to the FTP server.

\* Enter not more than 31 characters. Enter not more than 127 characters for ZIXI setting.

#### ■ PASV Mode

For setting whether to set the communication mode used for file transfer to the passive mode.

Set to "On" if the camera is inside a firewall, and a connection from the FTP server to the camera cannot be established.

[Setting Values: On, ●Off]

Memo : \_\_\_\_\_

- When [Protocol] is configured to "SFTP" or "ZIXI", this item appears as "---" and cannot be selected.

# Overlay Settings Menu

**550** **SPC**

This screen is used to configure overlay settings. Images can be overlaid onto recorded video and live stream video.

## Overlay Function

For specifying whether to activate the overlay function.

[Setting Values: Enable, ●Disable]

Memo : \_\_\_\_\_

- The setting cannot be changed during recording, streaming or Return over IP.
- When [System] is configured to a setting other than “HD” and “HD+Web”, this item is fixed at “Disable”.
- When “Disable” is selected, settings of the overlay function cannot be changed.

## Layout

For selecting a SDP file.

Memo : \_\_\_\_\_

- Create a SDP file using SDP Generator in Windows or Mac before recording.

## Import User Layout

Load the SDP file that is created by using SDP Generator onto this camera recorder.

Memo : \_\_\_\_\_

- Maximum 4 files can be saved in this camera recorder.
- The SDP file may not be saved depending on the available memory capacity of the camera recorder.

## Delete User Layout

For deleting the SDP file.

Memo : \_\_\_\_\_

- The SDP file is not deleted by selecting [System] → [Reset All]. Delete the file from the camera recorder.

## Type

By selecting [Type], overlay images can be displayed.

The selectable types of scoreboards vary with the [Layout] settings. **SPC**

[Setting Values: Broadcast, ●None] **550**

[Setting Values: Broadcast, Basketball, Baseball, Football, Type 2, Type 1, ●None] **SPC**

Memo : \_\_\_\_\_

- Selecting [Layout] or [Type] of the scoreboard overlay imported using [Import User Layout] displays the team settings menu. **SPC**

## Overlay Custom Menu

The display changes according to the imported data.

### Output

For specifying overlay output settings.

#### ↳ HD Recording

For setting whether to record overlay images together with the recorded video into an SD card.

- On:  
Saves the video with overlay images into an SD card.
- Off:  
Overlay images are not recorded into an SD card.

[Setting Values: ●On, Off]

#### ↳ HDMI

For setting whether to display overlay images on HDMI output.

- On:  
Displays overlay images on streaming videos and HDMI output.
- Off:  
Displays overlay images only on streaming videos.

[Setting Values: ●On, Off]

#### ↳ SDI (Fixed)

Displays overlay images on the SDI output. Setting is fixed at “On” and cannot be changed.



**↳ Proxy Recording (Fixed)**

Displays overlay images on the recording in slot B when [System] is configured to “HD+Web”. Setting is fixed at “On” and cannot be changed.

**↳ Live Streaming (Fixed)**

Displays overlay images on live streaming videos. Setting is fixed at “On” and cannot be changed.

**Sportzcast SPC**

This camera recorder can be linked to a Sportzcast product to automatically import the scoreboard data at sports stadiums.

- **Connect:**  
Connects to the preconfigured Sportzcast server.
- **Disconnect:**  
Terminates the current connection with the Sportzcast server.

[Setting Values: Connect, ●Disconnect]

Memo : \_\_\_\_\_

- “Connect” cannot be selected if network connection is not established.
- Switches to “Disconnect” upon shifting to a mode other than the Record mode or when the unit is powered off.
- [Settings] cannot be selected when [Overlay Settings] → [Sportzcast] is configured to “Connect”.

**↳ Settings**

For specifying settings related to Sportzcast.  
(☞ P146 [Settings Item SPC (Sportzcast)])

**Watermark**

Inserting watermarks (digital watermark) on recorded videos protects the content of your work.

- **On:**  
Displays watermark.
- **Off:**  
Does not display watermark.

[Setting Values: On, ●Off]

Memo : \_\_\_\_\_

- It can be displayed when the SDP file for which “Watermark” is preconfigured is selected in [Layout].

**↳ Position**

The display position of the watermark can be changed by using the cross-shaped button.

**Full Screen Graphic**

Images can be displayed across the whole screen.

**↳ Status**

For displaying the number of images saved in this camera recorder and the memory capacity used.  
(☞ P216 [Displaying Images on the Whole Screen (Full Screen Graphic Function)])

**↳ Import Graphic A / B**

For reading the images to be used in Full Screen Graphic from an SD card.

Memo : \_\_\_\_\_

- JPEG and PNG formats are supported.
- Enter not more than 31 characters for the file name.

**↳ Delete Graphic**

For deleting all images saved in this camera recorder.

**Password Lock**

The Overlay Settings menu can be locked with a password.

- **On:**  
A password is required to open the Overlay Settings menu.
- **Off:**  
Opens the Overlay Settings menu without a password.

[Setting Values: On, ●Off]

(☞ P218 [Protecting Overlay Settings with a Password])

Caution : \_\_\_\_\_

- Do not forget the password that you have set. If the password is lost or forgotten, you cannot deactivate the password protection function.

## Settings Item **SPC** (Sportzcast)

### Server

Select the server to connect to.

- Cloud:  
For configuring the setting when connecting to the Sportzcast cloud service.

[Setting Values: ●Cloud, Server1 to Server3]

### ↳ Sever Settings

#### ■ Alias

For setting a name to distinguish the settings of this camera. The name set in this item will be displayed in the [Server] options.

- \*1 The default value is “Cloud/Server1/Server2/Server3”.
- \*2 You can enter up to 31 characters and ASCII characters.

#### ■ Address

For configuring details such as the host name and the IP address of the destination of connection.

- \* Enter not more than 127 characters using single-byte alphanumeric characters (a to z, 0 to 9), single-byte hyphen [-] or dot [.]

#### ■ Broadcast

Set to “On” when connecting 3 or more Scorebot units to the camera at the same time. The broadcast setting on the Scorebot also needs to be set to “On”. For details on how to configure the setting on the Scorebot, please consult “Sportzcast”.

[Setting Values: On, ●Off]

### ↳ Search Local Server

For searching local servers (Scorebot) that are connected to the same local network as the camera through the Wizard and configuring the selected Scorebot to the [Server Settings].

Memo : \_\_\_\_\_

- If a Scorebot is currently being connected, search cannot be performed until the connection has been terminated.
- Old settings that are saved in [Server Settings] at the storage destination will be overwritten.
- Connection is automatically established upon exiting the Wizard, and the [Server] setting switches to [Server Settings] while the camera is connected to the Scorebot.

### ↳ License Name

Enter the license name provided by Sportzcast. A license name that is currently in use by another camera cannot be used.

### ↳ BOT Number

Enter the BOT number provided by Sportzcast.

### ↳ Channel

Enter the channel provided by Sportzcast.

### Score Input Source

For selecting whether to acquire the next score information from the server or to manually input the score from the web browser screen when [Sportzcast] is set to “Connect”. This option comes in handy when you want to manually enter only a part of the information.

Memo : \_\_\_\_\_

- The [Display] and [Overlay] buttons on the web browser screen remain enabled at all times regardless of the setting of this item.
- The [Display] and [Overlay] buttons on the web browser screen remain enabled at all times regardless of the setting of this item.
- If the overlay display is not updated even though the camera recorder is connected to a Sportzcast server, check whether “Sportzcast” is selected for each of the [Score Input Source] items.

### ↳ Display Order (Home)

For selecting whether to display the score information of the home team that is acquired from the Sportzcast in the left or right column (or upper or lower row). However, in the case of a baseball game, the score is always displayed in the lower row regardless of the setting.

- Last:  
Displays the score in the right column or lower row.
- First:  
Displays the score in the left column or upper row.

[Setting Values: ●Last, First]

### ↳ Team Name

For selecting the data reference source for the team name.

[Setting Values: ●Sportscast, Web]

### ↳ Shot Clock

For selecting the data reference source for the shot clock.

[Setting Values: ●Sportscast, Web]

### ↳ Others

For selecting the data reference source for score information not included in the respective settings.

[Setting Values: ●Sportscast, Web]

# System Menu

This menu screen allows system-related settings. For configuring recording settings, formatting and restoration of a recording media, tally lamp setting, date/time, time zone and other settings. It can also be used to reset the menu settings to their default values.

## Record Set...

For specifying recorded video-related settings.  
(☞ P149 [Record Set Item] )

## Media

### ↳ Format Media

For formatting (initializing) a recording media. Select a card slot, select [Format] from [Cancel]/[Format], and press the Set button (●) to format (initialize) the card.

(☞ P51 [Formatting (Initializing) of Recording Media] )

### ↳ Restore Media

For restoring a recording media. Select a card slot, and press the Set button (●) to restore the recording media.

(☞ P52 [Repairing the Recording Media] )

Memo : \_\_\_\_\_

- [! RESTORE] appears in the remaining level display area when a recording media that requires repair is inserted. However, it is not selectable when recording in Camera mode and during Clip Review.

## Setup File

This allows you to save the menu settings as well as the performance results of shutter speed and AWB.

It is useful to save settings according to different shooting conditions.

### ↳ Load File...

Loads the settings.

(☞ P174 [Loading a Setup File] )

### ↳ Store File...

Saves the settings.

(☞ P173 [Saving Setup Files] )

### ↳ Delete File...

Deletes the settings.

(☞ P174 [Deleting Setup Files] )

## Tally Lamp

For setting whether to light up the tally lamp during recording, when the remaining space warning is displayed, or during live streaming.

Memo : \_\_\_\_\_

- The blinking warning display, such as when the remaining battery level is low, is enabled in a setting other than "Off".

- Rec/Live Streaming:  
Lights up during recording or live streaming.
- Live Streaming:  
Lights up during live streaming. Does not light up during recording.
- Rec:  
Lights up during recording.
- External:  
Lights up when the camera recorder is controlled by an external device such as RM-LP100.  
When external is selected, [PVW] is displayed on the LCD/VF screen during Preview Tally, and [PGM] is displayed on the LCD/VF screen during Program Tally.
- Off:  
Turns off the indicator.

[Setting Values: Rec/Live Streaming, Live Streaming, ●Rec, External, Off]

**NETWORK LED**

When this is configured to “On”, it lights up in red when live streaming is in progress. The LED lights up in orange during poor streaming connection or connection failure.  
[Setting Values: ●On, Off]

**STATUS LED**

For configuring the STATUS LED.

- **REC/Pre Rec:**  
Lights up in red during recording or transition to recording. Lights up in orange when the remaining space on the recording media is running low. Lights up in green when Pre Rec is on standby.
- **External:**  
Lights up in red while in the Program mode when an external device such as RM-LP100 is connected. Lights up in green while in the Preview mode.
- **Return over IP:**  
Lights up in green during Return over IP or when IFB is in progress. Lights up in orange when an error has occurred.
- **Off:**  
Does not light up.

[Setting Values: ●REC/Pre Rec, External, Return over IP, Off]

**LED Bright**

For specifying the brightness of the NETWORK LED and STATUS LED.

[Setting Values: High, Middle, Low]

**GPS** 550 SPC

For setting the GPS function to On or Off (power on/off).

[Setting Values: On, ●Off]

Memo : \_\_\_\_\_

- When [A/V Set] → [Video Set] → [SDI OUT1 Res.] is set to “1080p”, configuring [System] → [GPS] to “On” changes the setting to “1080i”.

**Language**

Switches between languages in the menu screen.  
[Setting Values: ●English, Français, Español] (U model)

[Setting Values: ●English, Français, Deutsch, Italiano, Español, Русский, Türkçe] (E model)

**Reset All**

Resets all menu settings.

Memo : \_\_\_\_\_

- [Date/Time] and [Time Zone] cannot be reset.  
(☞ P148 [ Date/Time ] )  
(☞ P149 [ Time Zone ] )
- This item is not selectable when recording in Camera mode, during Clip Review, during live streaming and in Media mode.

**Date/Time**

For setting the year, month, day, hour, and minute.

Memo : \_\_\_\_\_

- The display order of the date (year, month, day) follows the setting in [Display Settings] → [Date Style]. However, the 24-hour format is used for the hour display regardless of the [Time Style] setting.  
(☞ P149 [ Time Style ] )
- For setting the time acquired from the GPS satellite by pressing the [FOCUS ASSIST/1] button if radio wave reception from the GPS satellite allows for setting of the date and time. The [USER1] button is grayed out if information for setting the date and time cannot be acquired from the GPS satellite. 550 SPC

**Date Style**

For setting the date display sequence for display on the LCD monitor and viewfinder screen as well as for time stamp recording.

Display examples of the setting values are as follows.

- DMY2: 30 Jun 2019
- DMY1: 30-06-2019
- MDY2: Jun 30, 2019
- MDY1: 06-30-2019
- YMD: 2019-06-30

[Setting Values: DMY2, DMY1, MDY1, MDY2, YMD]

(Default values: MDY2 (U model), DMY1 (E model))

## Time Style

For setting the time display for display on the LCD monitor and viewfinder screen as well as for time stamp recording.

[Setting Values: ●24hour, 12hour]

## Time Zone

For setting the UTC time difference in units of 30 minutes.

[Setting Values: UTC-12:00-UTC-00:30, UTC, UTC+00:30-UTC+14:00 (in 30 min increments)]  
(Default values: UTC-05:00 (U model), UTC (E model))

Memo : \_\_\_\_\_

- If [Date/Time] is already set, the [Date/Time] item is automatically adjusted when [Time Zone] is altered.

## Reserved

For setting the additional function to "On" or "Off".

### ↳ Reserved 1 to Reserved 16

Normally set to "Off".

[Setting Values: On, ●Off]

## System Information

### ↳ Version

Displays information on the firmware version.

Display : 0000-0000

### ↳ Fan Hour

For displaying the usage time of the internal fan.

Memo : \_\_\_\_\_

- Under normal environment, dust will accumulate on the internal fan when the camera recorder is used over a long period. Dust may enter the camera recorder especially if it is used outdoors. This may affect the image and sound quality of the camera recorder. Check and replace the fan after every 9000 hours (suggested guideline).

### ↳ Open Source License

Displays the license for the open source software used by this camera recorder.

## Record Set Item

### Record Format

After setting of all items in the [Record Format] menu is complete, select [Set] at the bottom of the screen to apply the new settings on the camera recorder and switch the recording format. A "Please Wait..." message appears during switching.

### ↳ System

For selecting a system definition.

- 4K EXT (SSD):  
Records videos in "4K EXT" quality to [EXT.SLOT] (SSD media).
- 4K:  
Records in "4K" quality for both slots A and B.
- HD:  
Records in "HD" (High Definition) quality for both slots A and B.
- SD:  
Records in "SD" (Standard Definition) quality for both slots A and B.
- HD+Web:  
Records in "HD" (high definition) for slot A, and in resolution suitable for web distribution for slot B.
- High-Speed:  
Records slow motion videos in "HD" (High Definition) for both slot A and slot B.

[Setting Values: 4K EXT (SSD), 4K, ●HD, SD, HD+Web, High-Speed]

Caution : \_\_\_\_\_

- The selectable options for the [AFormat]/[EXTFormat], [AResolution]/[EXTResolution], [AFrame Rate]/[EXTFrame Rate], [ABit Rate]/[EXTBit Rate], [AAudio]/[EXTAudio], [BFormat], [BResolution], [BFrame Rate], [BBit Rate] and [BAudio] settings vary depending on the setting of this item.

↳ **[A]Format/ [EXT]Format**

For selecting the format of the file to be recorded to the recording media in slot A or [EXT.SLOT].

- QuickTime(MPEG2):  
QuickTime file format (.MOV)
- MXF(MPEG2):  
MXF (material exchange format)
- QuickTime(H.264):  
QuickTime file format (.MOV)
- Exchange: (U model only)  
Sports Video Interop Group format
- MP4 (H.264): (E model only)  
MP4 file format

[Setting Values: QuickTime(MPEG2), MXF(MPEG2), ●QuickTime(H.264), Exchange] (U model only) **500**

[Setting Values: QuickTime(MPEG2), MXF(MPEG2), ●QuickTime(H.264), MP4 (H.264)](E model only) **500**

[Setting Values: ●QuickTime(H.264), Exchange] (U model only) **500**

[Setting Values: ●QuickTime(H.264), MP4 (H.264)](E model only) **500**

[Setting Values: QuickTime(H.264), ●Exchange]

**SPC**

Memo : \_\_\_\_\_

- When [System] is set to “4K EXT (SSD)”, this item is fixed at “ProRes”.
- When [System] is set to “4K”, “SD”, “HD+Web”, or “High-Speed”, this item is fixed at “QuickTime(H.264)”.
- Exchange file format can be selected only when [System] is set to “HD”.
- Exchange format is used under license from Sports Video Interoperability Group, Inc..

↳ **[A]Resolution/ [EXT]Resolution**

For selecting the size of the still image to be recorded to the recording media in slot A or [EXT.SLOT]. (Horizontal x vertical)

The available options vary according to the settings of [System] and **[A]Format**.

- When [System] is set to “4K EXT (SSD)” or “4K”:  
Fixed at “3840x2160”.
- When [System] is set to “HD”, and **[A]Format** is set to “QuickTime(MPEG2)” or “MXF(MPEG2)”:  
[Setting Values: ●1920x1080, 1440x1080, 1280x720]
- When [System] is set to “HD”, and **[A]Format** is set to “QuickTime(H.264)”:  
[Setting Values: 1920x1080, 1280x720]
- When [System] is set to “HD”, and **[A]Format** is set to “Exchange” (U model only):  
[Setting Values: 1920x1080, 1280x720]
- When [System] is set to “HD”, and **[A]Format** is set to “MP4(H.264)” (E model only):  
[Setting Values: 1920x1080, 1280x720]
- When [System] is set to “HD+Web”:  
[Setting Values: 1920x1080, 1280x720]
- When [System] is set to “High-Speed”:  
Fixed at “1920x1080”.
- When [System] is set to “SD”:  
Fixed at either “720x480” or “720x576”.

Memo : \_\_\_\_\_

- The selectable values of **[A]Frame Rate/ [EXT]Frame Rate**] and **[A]Bit Rate/[EXT]Bit Rate**] vary according to the setting of this item.

## ↳ **[A]Frame Rate/ [EXT]Frame Rate**

For selecting the frame rate for recording to the recording media in slot A or [EXT.SLOT].

The available options vary according to the settings for [System], **[A]Resolution/ [EXT]Resolution** and **[A]Format/ [EXT]Format**.

- When [System] is set to “4K EXT (SSD)”:  
[Setting Values: 60p, 50p, 30p, 25p, 24p]
- When [System] is set to “4K”:  
[Setting Values: 30p, 25p, 24p]
- When [System] is set to “HD”, **[A]Format** is set to “QuickTime(MPEG2)” or “MXF(MPEG2)” **550**, and **[A]Resolution** is set to “1920x1080”:  
[Setting Values: 60i, 50i, 30p, 25p]
- When [System] is set to “HD” or “HD+Web”, **[A]Format** is set to “QuickTime(H.264)”, and **[A]Resolution** is set to “1920x1080”:  
[Setting Values: 60p, 60i, 50p, 50i, 30p, 25p, 24p]
- When [System] is set to “HD”, and **[A]Resolution** to “1440x1080”:  
[Setting Values: 60i, 50i]
- When [System] is set to “HD” or “HD+Web” and **[A]Resolution** is set to “1280x720”:  
[Setting Values: 60p, 50p]
- When [System] is set to “HD”, and **[A]Format** to “Exchange”:  
Fixed at “60p”. (U model only)
- When [System] is set to “HD”, and **[A]Format** to “MP4(H.264)”:  
Fixed at “50p”. (E model only)
- When [System] is set to “SD”:  
Fixed at “60”. (U model only)
- When [System] is set to “SD”:  
Fixed at “50”. (E model only)
- When [System] is set to “High-Speed”:  
[Setting Values: 120/60p, 100/50p, 120/30p, 100/25p, 120/24p]

## ↳ **[A]Bit Rate/ [EXT]Bit Rate**

For selecting the bit rate for recording to the recording media in slot A or [EXT.SLOT].

The available options vary according to the settings for [System], **[A]Resolution/ [EXT]Resolution** and **[A]Format/ [EXT]Format**.

- When [System] is set to “4K EXT (SSD)”:  
[Setting Values: 422HQ, 422, 422LT]
- When [System] is set to “4K”:  
[Setting Values: **4:2:2:1:0** 150M, 150M, 70M]
- When [System] is set to “HD”, **[A]Format** is set to “QuickTime(MPEG2)” or “MXF(MPEG2)” **550**, and **[A]Resolution** is set to “1440x1080”:  
[Setting Values: 35M (HQ), 25M (SP)]
- \* When **[A]Resolution** is set to a setting other than “1440x1080”, it is fixed at “35M (HQ)”.
- When [System] is set to “HD” or “HD+Web” and **[A]Format** is set to “QuickTime(H.264)”:
  - When **[A]Resolution** is set to “1920x1080”, and **[A]Frame Rate** is set to “60p” or “50p”:  
[Setting Values: **4:2:2:1:0** 70M (XHQ), **4:2:2:1:0** 50M (XHQ), 50M (XHQ)]
  - When **[A]Resolution** is set to “1920x1080”, and **[A]Frame Rate** to “60i”/“50i”/“30p”/“25p”/“24p”:  
[Setting Values: **4:2:2:1:0** 50M (XHQ), 50M (XHQ), 35M (UHQ)]
  - When **[A]Resolution** is set to “1280x720”:  
[Setting Values: **4:2:2:1:0** 50M (XHQ), 35M (UHQ)]
- When [System] is set to “HD”, and **[A]Format** to “Exchange” (U model only):
- When [System] is set to “HD”, and **[A]Format** to “MP4(H.264)” (E model only):
  - When **[A]Resolution** is set to “1920x1080”:  
Fixed at “12M(LP)”.
  - When **[A]Resolution** is set to “1280x720”:  
Fixed at “8M(LP)”.
- When [System] is set to “SD”:  
Fixed at 8M (HQ).
- When [System] is set to “High-Speed”:
  - When **[A]Frame Rate** is set to “120/60p” or “100/50p”  
[Setting Values: **4:2:2:1:0** 70M (XHQ), **4:2:2:1:0** 50M (XHQ), 50M (UHQ)]
  - When **[A]Frame Rate** is configured to a setting other than “120/60p” and “100/50p”  
[Setting Values: **4:2:2:1:0** 50M (XHQ), 50M (XHQ), 35M (UHQ)]

↳ **A Audio/ [EXT]Audio**

For switching to the audio that is to be recorded to the recording media in slot A or [EXT.SLOT].

The selectable options vary according to the settings in [A Format]/[EXT Format] or [A Bit Rate]/[EXT Bit Rate].

↳ **B Format**

For selecting the format of the file to be recorded to the SD card in slot B when [System] is configured to “HD+Web”.

This is fixed at QuickTime (H.264).

Memo : \_\_\_\_\_

- When [System] is set to other than “HD+Web”, this item is fixed at the same setting as [A Format].

↳ **B Resolution**

For selecting the size of the image to be recorded to the SD card in slot B when [System] is configured to “HD+Web”. (Horizontal x vertical)

- When [System] is set to “HD+Web”:
  - When [A Frame Rate] is configured to “60p”/“30p”  
[Setting Values: 960x540, 720x480, 480x270]
  - When [A Frame Rate] is configured to “50p”/“25p”  
[Setting Values: 960x540, 720x576, 480x270]
  - When [A Frame Rate] is configured to “24p”  
[Setting Values: 960x540, 480x270]

Memo : \_\_\_\_\_

- When [System] is set to other than “HD+Web”, this item is fixed at the same setting as [A Resolution].

↳ **B Frame Rate**

The frame rate of the image to be recorded to the SD card in slot B is fixed when [System] is set to “HD+Web”.

The value fixed varies according to the settings for [A Frame Rate].

- Fixed at “60i”, “50i”, “30p”, “25p” or “24p”.

Memo : \_\_\_\_\_

- When [System] is set to other than “HD+Web”, this item is fixed at the same setting as [A Frame Rate].

↳ **B Bit Rate**

The bit rate of the image to be recorded to the SD card in slot B is fixed when [System] is set to “HD+Web”.

The value fixed varies according to the settings for [B Resolution].

- “3M(HQ)” when [B Resolution] is configured to “960x540”
- “1.2M(LP)” when [B Resolution] is configured to “480x270”
- “8M(HQ)” when [B Resolution] is configured to “720x480” or “720x576”

Memo : \_\_\_\_\_

- When [System] is set to other than “HD+Web”, this item is fixed at the same setting as [A Bit Rate].

↳ **B Audio**

The audio to be recorded to slot B is the same as the audio to be recorded to slot A.

↳ **SD Aspect**

For setting the aspect ratio of the image when [System] is set to “SD”.

[Setting Values: ●16:9, 4:3]

Memo : \_\_\_\_\_

- For conditions other than those above, this item is fixed at “16:9”.



## Rec Mode

- For selecting the mode for recording to the recording media.

( P91 [Special Recording] )

[Setting Values: ●Normal, Pre Rec, Clip Continuous, Interval Rec, Frame Rec]

Memo : \_\_\_\_\_

- When [Slot Mode] is set to "Backup", this item is fixed at "Normal".
- This is fixed at "Normal" when [System] → [Record Format] → [System] is configured to any of the following.
  - 4K EXT (SSD)
  - HD+Web
  - High-Speed

### ↳ Pre Rec Time

For setting the pre-recording time when [Rec Mode] is set to "Pre Rec".

[Setting Values: ●5sec, 10sec, 15sec]

Memo : \_\_\_\_\_

- When [System] → [Record Set] → [Record Format] → [System] is set to "4K", this item is fixed at "5sec".

### ↳ Rec Frames

For setting the number of frames to record when [Rec Mode] is set to "Frame Rec" or "Interval Rec".

[Setting Values: ●1frame, 3frames, 6frames]

### ↳ Rec Interval

For setting the recording time interval when [Rec Mode] is set to "Interval Rec".

[Setting Values: ●1sec, 2sec, 5sec, 10sec, 30sec, 1min, 2min, 5min, 10min, 30min, 1hour]

## Slot Mode

For setting the operation of the card slot.

- Series:
    - Mode that activates slots A and B sequentially.
  - Dual:
    - Mode that activates slots A and B simultaneously.
  - Backup:
    - Mode that enables recording to slot B without using the [REC] button. This item is selectable only when [Rec Mode] is set to "Normal". Record, start and stop operations can be controlled from the [Backup Rec] menu or using the user button that is assigned with "Backup Trig".
- ( P88 [Dual Rec] )
- ( P89 [Backup Rec] )

[Setting Values: ●Series, Dual, Backup]

Memo : \_\_\_\_\_

- When this is configured to "Series" and recordable media is inserted into slot A or slot B or both the slots, pressing the [REC] button starts recording only to the card in the selected slot (active slot).
- When this is configured to "Dual" and recordable media are inserted into both slots A and B, pressing the [REC] button starts simultaneous recording to the cards in both slots.
- When [System] is configured to 4K EXT (SSD) or "HD+Web", "---" is displayed.
- When [System] is set to "High-Speed", this item is fixed at "Series".

### ↳ Backup Rec

For starting/stopping backup recording with [REC]/[STBY].

This item is selectable only when [Slot Mode] is set to "Backup".

Memo : \_\_\_\_\_

- When recording is stopped due to no remaining space on the media, etc., this item is fixed at "STOP" and cannot be selected.

### 4GB File Spanning(SDXC)

A recording file is automatically split when the size exceeds 4 GB, but if an SDXC card is used, you can record clips larger than 4 GB by setting this option to “Off”. (Up to a maximum of 64 GB or 4 hours)

- On:  
Splits a file when it exceeds 4 GB or 30 minutes.
- Off:  
Splits a file when it exceeds 64 GB or 4 hours.

[Setting Values: ●On, Off]

Memo : \_\_\_\_\_

- This option is only valid if the SD card used for recording is of the SDXC format.
- During simultaneous recording, such as Dual Rec and backup recording, this option is valid only when the SD cards in slots A and B are of the SDXC format.

### LPCM (QuickTime)

For setting the audio recording format of QuickTime.



[Setting Values: Dual Mono, ●Stereo]

### Time Stamp

For setting whether to display shooting date/time information in the recorded video.

[Setting Values: On, ●Off]

Memo : \_\_\_\_\_

- The date/time display style can be changed in [Date Style]/[Time Style].  
( P148 [ Date Style ] )  
( P149 [ Time Style ] )
- The setting cannot be changed during recording, streaming or Return over IP.
- When [System] is set to “4K EXT (SSD)”, “4K” or “High-Speed”, this item is fixed at “Off”.
- When [Overlay Function] is set to “Enable”, this item is fixed at “Off”. **550 SPC**

### Clip Set

#### ↳ Clip Name Prefix

For configuring the first four characters of the name of the clip file to be recorded to the recording media. Enter any of the 36 characters including alphabets (upper case) and numbers (0 to 9) using the software keyboard.

( P109 [Text Input with Software Keyboard] )

[Setting Values: xxxG] (The default value of xxx is the last three digits of the serial number.)

#### ↳ Reset Clip Number

For assigning a new number (Clip Number) by resetting it (0001).

Select [Reset] and press the Set button (●) to reset the number.

If there are other clips on the recording media, it will be assigned with the smallest available number.

- Example:  
If the [Clip Name Prefix] is “ABCD” and “ABCD0001” already exists on the recording media, “ABCD0002” will be assigned.

### Clear Planning Metadata

Erases the planning metadata downloaded from the FTP server.

This item also deletes the metadata loaded using the setup files (“User File”/“All File”).

# Adding/Editing Frequently Used Menu Items (Favorites Menu)

You can select and add/edit frequently used menu items freely to create a personal menu screen (Favorites Menu).

Memo : \_\_\_\_\_

- [Favorites Menu] is only enabled in the Camera mode. [Favorites Menu] remains unchanged even when the recording format changes.
- Up to 20 menu items can be added.
- Added items in [Favorites Menu] will not be reset even when [System] → [Reset All] is executed.
- Long descriptive names may be displayed for the menu items in [Favorites Menu] to enable better understanding.

## | Adding Menu Items to Favorites Menu

- 1 Press the [MENU/THUMB] button to open the [Main Menu] screen.
- 2 Select the menu or submenu item to add.



Memo : \_\_\_\_\_

- Adding items to [Favorites Menu] cannot be performed in the following cases. [USER1 Add] is displayed in gray in the operation guide.
  - Selected item is already added to [Favorites Menu].
  - Number of menu items that can be added (20 items) is exceeded.

- 3 Press the [FOCUS ASSIST/1] button.  
A screen to confirm the addition appears.
- 4 Select [Add] and press the Set button (●).  
The selected menu item is added to [Favorites Menu].

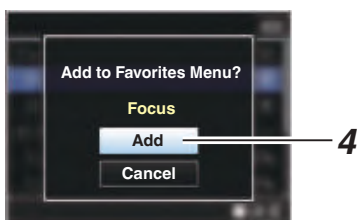

## Editing Favorites Menu

You can delete or change the order of the items added to [Favorites Menu].

### Deleting Items from [Favorites Menu]

#### 1 Open the [Favorites Menu] screen.

- ① Press the [MENU/THUMB] button to open the [Main Menu] screen.
- ② Press the [DISPLAY] button or press and hold down the [MENU/THUMB] button to open the [Favorites Menu] screen.

#### 2 Select [Edit Favorites] and press the Set button (●) or crossed-shaped button (▶).

The header turns magenta and the editing mode is activated.

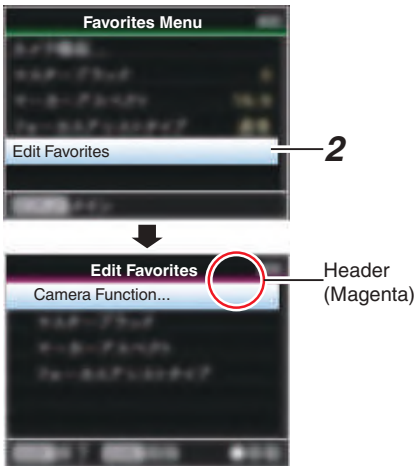

#### 3 Select the menu or submenu item to delete.



#### 4 Press the [OIS/2] button.

A delete mark (X) appears at the beginning of the menu item.

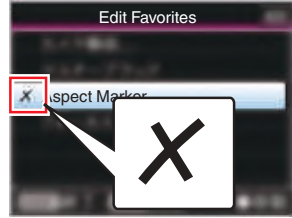

Memo :

- When the [OIS/2] button is pressed again while the menu item with the delete mark (X) is selected, the menu item will be excluded from the items to be deleted and the delete mark (X) disappears.

#### 5 Press the [FOCUS ASSIST/1] button.

The option menu to exit the [Favorites Menu] editing mode appears.

#### 6 Select [Save & Exit] and press the Set button (●).

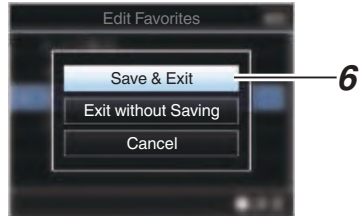

Memo :

- Deletion is not complete until the changes are saved with [Save & Exit].
- To exit the editing mode without deleting any items, select [Exit without Saving].
- To return to the editing mode, select [Cancel].

## Changing the Order of Items in [Favorites Menu]

- 1 Open the [Favorites Menu] screen.**  
Press the [MENU/THUMB] button to open the [Favorites Menu] screen.
- 2 Select [Edit Favorites] and press the Set button (●) or crossed-shaped button (▶).**  
The header turns magenta and the editing mode is activated.

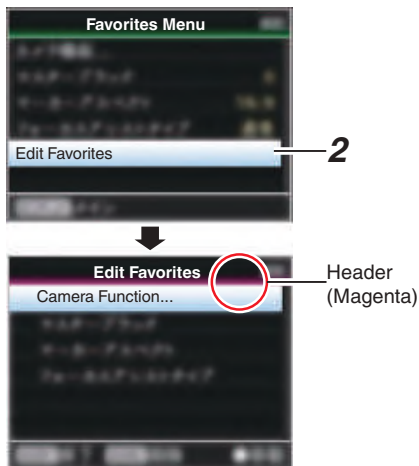

- 3 Select the menu or submenu item to move and press the Set button (●).**  
The moving mode is activated and a position selection bar for the move appears.

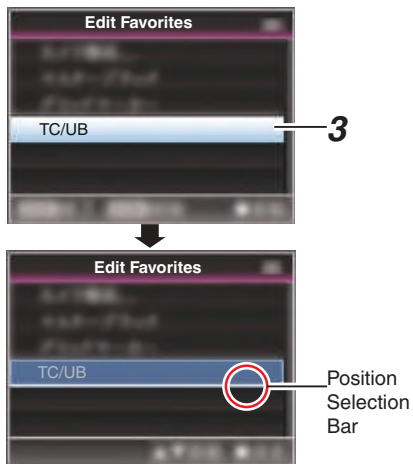

- 4 Select the position to move to with the cross-shaped button (▲▼).**  
Move the position selection bar with the cross-shaped button (▲▼) and select a position to move to.
- 5 Press the Set button (●).**  
The selected item moves to the new position.

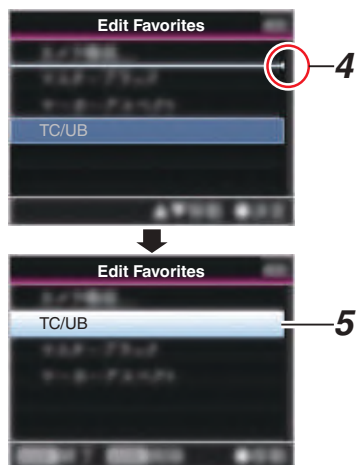

- 6 Press the [FOCUS ASSIST/1] button.  
The option menu to exit the [Favorites Menu] editing mode appears.
- 7 Select [Save & Exit] and press the Set button (●).

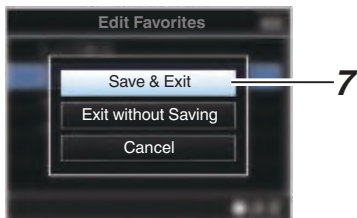

Memo : \_\_\_\_\_

- Moving is not complete until the changes are saved with [Save & Exit].
  - To exit the editing mode without saving any changes, select [Exit without Saving].
  - To return to the editing mode, select [Cancel].
- \_\_\_\_\_

# Display Screen in Camera Mode

When the display setting for [LCD/VF] → [Display On/Off] is set to “Off”, the corresponding display is hidden. However, the display may appear during event display or warning display.

Memo : \_\_\_\_\_

- When the display setting for [LCD/VF] → [Display On/Off] is set to “On”, the display screen appears only in the following cases if it has been turned off.
  - Approximately 3 seconds when changes are being made
  - During event display or warning display

## Display Screen

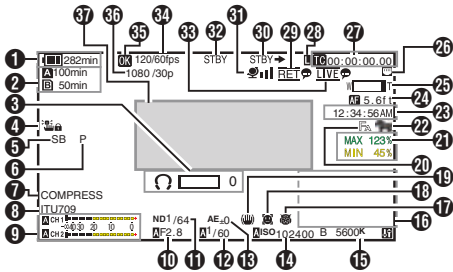

- 1 Voltage/Battery Power**  
Displays the current status of the power supply in use.  
(☞ P37 [Power Status Display] )

Memo : \_\_\_\_\_

- Even when the display screen is turned off and [LCD/VF] → [Display On/Off] → [Battery] is set to “Off”, this will be displayed when there is a warning.

- 2 Remaining Space on Media**  
Displays the remaining recording time for the recording media in slot A and slot B separately.

**A B** : Currently selected slot. (White card)

**EXT**

**A**

: Write-protect switch of SD card is set.

**A!INVALID** : When a recording media writing/reading error has occurred, or when the recording media is irreparable.

**A!FORMAT** : Recording media requires formatting.

**A!RESTORE** : Recording media requires repair.

- A!INCORRECT** :
- Recording media is not supported.
  - When an SD card lower than Class 10 is inserted while in the XHQ mode.

- A!REC INH** :
- When attempting to record more than 4 GB while an SD card that does not support recording of more than 4 GB is inserted.  
(☞ P154 [4GB File Spanning(SDXC) ] )

The following icons are displayed during FTP upload.

(☞ P182 [Uploading a Recorded Video Clip] )

Icon	Status
	[Auto Upload] is configured to “On” and in the standby state. “A” is displayed at the top left corner of the icon while in the Auto FTP mode.
	Auto FTP transfer is in progress. Three images are alternately displayed, and the arrows become animated.
	FTP transfer is in progress. Three images are alternately displayed, and the arrows become animated. In this case, instead of the remaining recordable time on the recording media, an estimated value of the remaining transfer time is displayed.
	Error has occurred during FTP transfer.

Memo : \_\_\_\_\_

- The displayed time is an estimate.
- Even when the display screen is hidden and [LCD/VF] → [Display On/Off] → [Media Remain] is set to “Off”, this will be displayed when there is a warning.

- 3 Volume Operation Indicator**  
Displayed when there are changes made to the volume of the headphone (0 to 15), the values of LCD BRIGHT (☞) or PEAKING (☞) (-10 to +10).

- 4 Operation lock**  
The icon appears during operation lock.

Memo : \_\_\_\_\_

- The icon appears for 3 seconds after operation lock is turned off.





- 15** White Balance Mode  
 Displays the current white balance mode.  
 (\*\*\*\*K indicates color temperature)
- A \*\*\*\*K : When the [WHT BAL B/A/PRESET] switch is set to "A" in the Manual White Balance mode.
- B \*\*\*\*K : When the [WHT BAL B/A/PRESET] switch is set to "B" in the Manual White Balance mode.
- P \*\*\*\*K : When the [WHT BAL B/A/PRESET] switch is set to "PRESET" in the Manual White Balance mode.
- A** FAW : During Full Auto White Balance mode.
- L** FAW : While in the Full Auto White Balance mode, and [AE Lock] is set for "FAW" or "AE/FAW" during lock operation.
- ( P70 [Preset Mode (PRESET)])
- ( P71 [Memory A Mode (A), Memory B Mode (B)])

Memo : \_\_\_\_\_

- When [Preset Paint], [AWB Paint] or [FAW Paint] is set to a setting other than the default value, a icon is displayed to the right of the color temperature.

- 16** Expanded Focus/Histogram  
 Displayed upon pressing the user button that is assigned with "Expanded Focus" and "Histogram".

Memo : \_\_\_\_\_

- Display switches in the order of "Expanded Focus" > "Histogram".

- 17** Infrared Recording  
 is displayed when the infrared recording is ON.

- 18** Face Detection  
 Displayed when Face Detection is ON.
- : When [Face Detection] is set to "ON"
- ONLY : When [Face Only AF] is configured to "ON" while [Face Detection] is "ON"

- 19** Image Stabilizer Mark  
 Displayed when the image stabilizer is ON.
- : When [Level] of [OIS] is set to "Normal".
- : When [Level] of [OIS] is set to "High".

Memo : \_\_\_\_\_

- When Image Stabilizer is configured to "OFF", is displayed for 3 seconds.

- 20** Focus Assist
- "" is displayed when auto focus is activated.
  - When ACCU-Focus is enabled, "ACCU" blinks for about 10 seconds while Focus Assist starts up, after which the "" indicator lights up.
  - If recording starts while [ACCU-Focus] is active, [ACCU-Focus] will be forcibly deactivated.
- ( P126 [Focus Assist])

- 21** Luminance Information  
 Displayed when the Spot Meter function is activated.
- MAX : Maximum luminance  
 MIN : Minimum luminance

- 22** Zebra pattern  
 During zebra pattern display, (zebra icon) is displayed on the display screen in Camera mode.
- ( P82 [Setting Zebra Pattern])

- 23** Time Display  
 Displays the current time.

Memo : \_\_\_\_\_

- The date/time display style can be configured in [System] → [Date/Time].
- When [System] → [Record Set] → [Time Stamp] is set to "On", this item is not displayed.

- 24** Focus Display  
 Displays the focus state and the approximate distance to the subject in focus.
- : Manual focus  
 : Autofocus  
 : Autofocus lock
- : [AF Area]-"Wide"  
 : [AF Area]-"Multi"

Memo : \_\_\_\_\_

- The displayed unit of measurement (feet or meter) can be configured in [LCD/VF] → [Display Type] → [Focus].
- When focus display is grayed, Auto Focus cannot function.

**25** Zoom Display

- Displays the zoom position. (Zoom bar or value)

Dynamic Zoom Off:



Dynamic Zoom On:



- The zoom bar will only be displayed for 3 seconds after the zoom operation is activated.
- The value will always be displayed.  
Dynamic Zoom Off: Z00 to Z99  
Dynamic Zoom On: DZ000 to DZ149
- When [Digital Extender] is configured to “On”, “Z” is displayed to the right of the zoom display.

Memo : \_\_\_\_\_

- The mode of display (value or bar) can be configured in [LCD/VF] → [Display Type] → [Zoom].

**26** Network Connection Icon

The network connection status is displayed.

Icon	Status
	Wireless LAN connection from the host terminal (USB) is established
	Wired LAN connection from the host terminal (USB) is established
	Cellular adapter connection from the host terminal (USB) is established
	When a USB adapter different from the connection settings is detected
	Built-in wireless LAN connection is established
	LAN terminal connection is established
(No display)	<ul style="list-style-type: none"> <li>• When an unusable USB adapter is detected</li> <li>• When the LAN cable is not connected</li> </ul>

Memo : \_\_\_\_\_

- Yellow display indicates preparation for connection in progress.

**27** Time Code (TC)/User's Bit (UB) Display

- Displays the time code (hour: minute: second: frame) or user's bit data.
- Example of time code display:  
Display Screen



- \* Colon (: ) denotes non-drop frames and dot (.) denotes drop frames.

- Example of user's bit display:  
Display Screen



Memo : \_\_\_\_\_

- Use [LCD/VF] → [Display Type] → [TC/UB] to toggle between the time code display and user's bit display.

**28** Time Code Lock Indicator

When the built-in time code generator is synchronized to the external time code data input during the synchronization of time code with another camera recorder, lights up.

**29** IFB/RET Mark

Displays the status of the IFB or Return over IP.

Icon	Status
	During audio feed only
	When an error occurs during audio feed only
	During video+audio feed
	When an error occurs during video+audio feed

- 30 SDI/HDMI Record Trigger  
 STBY → : When [A/V Set] → [Video Set] → [SDI OUT] → [Rec Trigger] is set to “Type-A” or “Type-B”, or [HDMI OUT] → [Rec Trigger] is set to “On” and recording is stopped  
 REC → : When [A/V Set] → [Video Set] → [SDI OUT] → [Rec Trigger] is set to “Type-A” or “Type-B”, or [HDMI OUT] → [Rec Trigger] is set to “On” and recording is in progress



- 31 GPS Mark **550 SPC**  
 When [System] → [GPS] is set to “On”, the signal reception status is displayed.

Memo : \_\_\_\_\_

- The display changes according to the signal reception sensitivity. If signals cannot be received, the  mark appears in yellow regardless of the [LCD/VF] → [Display On/Off] → [GPS] setting.
- This item is not displayed when [GPS] is set to “Off”.

- 32 Media Status  
 ---- : A card is not detected in the selected slot, and [Tally Lamp] is configured to a setting other than “External” or [STATUS LED] is configured to a setting other than “External”  
 STBY : Recording standby  
 ●REC : Recording  
 REVIEW : Clip Review  
 (☞ P86 [Viewing Recorded Videos Immediately (Clip Review)])  
 STBY **P** : Pre Rec recording standby  
 (☞ P91 [Pre Rec])  
 ●REC **P** : Pre Rec recording  
 (☞ P91 [Pre Rec])  
 STBY **C** : Clip Continuous Rec recording standby  
 (☞ P92 [Clip Continuous Rec])  
 ●REC **C** : Clip Continuous Rec recording  
 (☞ P92 [Clip Continuous Rec])  
 STBY **C** : Clip Continuous Rec recording  
 (displayed in yellow) pause  
 (☞ P92 [Clip Continuous Rec])  
 STBY **I** : Interval Rec recording standby  
 (☞ P95 [Interval Rec])  
 STBY **I** : Interval recording pause  
 (displayed in red)  
 ●REC **I** : Interval Rec recording  
 (☞ P95 [Interval Rec])  
 STBY **F** : Frame Rec recording standby  
 (☞ P94 [Frame Rec])  
 ●REC **F** : Frame Rec recording  
 (☞ P94 [Frame Rec])  
 STBY **F** : Frame Rec recording pause  
 (displayed in yellow)  
 (☞ P94 [Frame Rec])  
 STOP : Unable to record to the card in the slot  
 P.OFF : Power OFF  
 ●✂ : During clip cutter recording (displayed for 3 seconds)  
 (☞ P96 [Splitting the Clips Freely (Clip Cutter Trig)])  
 PGM : Receiving program signals from an external device, such as a remote control unit  
 PVW : Receiving preview signals from an external device, such as a remote control unit

- 33 Live streaming mark  
When [Network] → [Live Streaming] → [Live Streaming] is set to “On”, the distribution status is displayed.  
(☞ P137 [Live Streaming Item] )

Icon	Status
 (Red)	Distribution in progress (good connection quality)
 (Red)	Distribution in progress (poor connection quality)
 (Yellow)	Waiting for connection (RTSP/RTP only), connection failed

- 34 High-Speed Frame Rate
  - When [System] → [Record Set] → [Record Format] → [System] is configured to “High-Speed”, the setting value for [Frame Rate] is displayed.
- 35 OK Mark  
Displayed when OK mark has been appended.  
(☞ P103 [Appending/Deleting OK Mark] )
- 36 Recording Format  
Displays the recording format.

Memo : \_\_\_\_\_

- The resolution, frame rate and bit rate can be viewed on the status screen.

- 37 Event/Warning Display Area  
Displays error messages.  
(☞ P231 [Error Messages and Actions] )

# Display Screen in Media Mode

When the display setting for [LCD/VF] → [Display On/Off] is set to "Off", the corresponding display is hidden.

Memo : \_\_\_\_\_

- Display on the information display area can be toggled using the [ONLINE/3] button.
- When the display setting for [LCD/VF] → [Display On/Off] is set to "On", the display screen appears only in the following cases if it has been turned off.
  - During event display or warning display

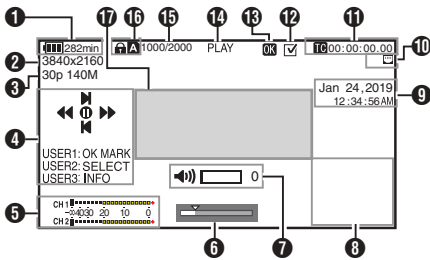

- 1 Voltage/Battery Power**  
Displays the current status of the power supply in use.  
(☞ P37 [Power Status Display])

Memo : \_\_\_\_\_

- Even when the display screen is turned off and [LCD/VF] → [Display On/Off] → [Battery] is set to "Off", this will be displayed when there is a warning.

- 2 Resolution**  
Displays the video image resolution.
- 3 Frame Rate/Bit Rate**  
Displays the frame rate and bit rate in pairs.
- 4 Operation Guide**  
Displays a guide for the current operation buttons.
- 5 Audio Level Meter**  
Displays the audio levels of CH1 and CH2.



- The display appears when the volume (0 to 15) of the headphone or speaker changes.  
(☞ P159 [Volume Operation Indicator])

- 6 Position Bar**  
Displays the current position in the video. During trimming, the position bar appears in green, and icons for the in and out points are displayed.

- ▼ : Current position of the video
- ▲ : Position to start trimming (In point)
- ▲ : Position to end trimming (Out point)

- 7 Volume Operation Indicator**  
Displayed when there are changes made to the volume of the headphone (🔊), speaker (🔊) (0 to 15), the values of LCD BRIGHT (☀️) or PEAKING (📊) (-10 to +10).

- 8 Information Display**  
Use the [ONLINE/3] button to switch between camera information display, GPS display and turning off the display.
  - The GPS display displays information on the recording location of the video being played back only when GPS information has been recorded.
  - Camera information display displays only information of Gain, Iris, Shutter and White Balance that have been recorded.

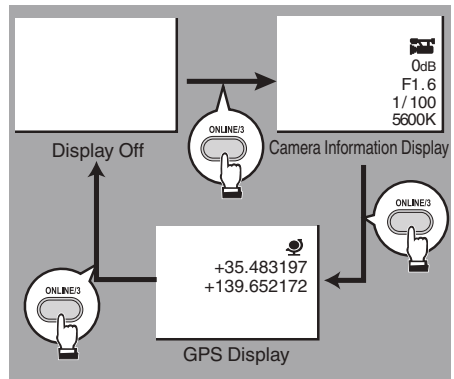

Memo : \_\_\_\_\_







- Trimming information is displayed while trimming is in progress. In this case, pressing the [ONLINE/3] button does not switch the display.
- The information display area is not subject to the display settings of the items in [LCD/VF] → [Display On/Off].

- 9** Date/Time Display  
Displays the date/time that is recorded on the currently played recording media.

Memo : \_\_\_\_\_

- The date/time display style can be specified in [System] → [Date Style]/[Time Style].  
(☞ P148 [ Date Style ] )  
(☞ P149 [ Time Style ] )

- 10** Network Connection Icon  
The network connection status is displayed.

Icon	Status
	Wireless LAN connection from the host terminal (USB) is established
	Wired LAN connection from the host terminal (USB) is established
	Cellular adapter connection from the host terminal (USB) is established
	When a USB adapter different from the connection settings is detected
	Built-in wireless LAN connection is established <b>550</b>
	LAN terminal connection is established
(No display)	<ul style="list-style-type: none"> <li>When an unusable USB adapter is detected</li> <li>When the LAN cable is not connected</li> </ul>

Memo : \_\_\_\_\_

- The icon appears blinking when the camera recorder is starting up, and is displayed in yellow while getting ready to connect.

- 11** Time Code (TC)/User's Bit (UB) Display
- Displays the time code (hour: minute: second: frame) or user's bit data recorded in the recording media being played back.
  - Example of time code display:

**TC00:00:00:00**  
\* ↓

- Colon (: ) denotes non-drop frames and dot (.) denotes drop frames.
- Example of user's bit display:

**UBFF EE DD 20**

Memo : \_\_\_\_\_

- Use [LCD/VF] → [Display Type] → [TC/UB] to toggle between the time code display and user's bit display.

- 12** Check Mark  
Displayed when the currently played clip is selected.
- 13** OK Mark  
Displayed when OK mark has been appended.  
(☞ P103 [Appending/Deleting OK Mark] )

- 14** Media Status
- PLAY : Playing  
STILL : Still picture playback mode  
FWD \* : High-speed playback in the forward direction (\* playback speed: 5x, 15x, 60x, or 360x)  
REV \* : High-speed playback in the reverse direction (\* reverse playback speed: 5x, 15x, 60x, or 360x)  
STOP : Stop mode  
P.OFF : Power OFF

- 15** Clip Information  
Displays current clip number/total number of clips.
- 16** Media
- Displays the media slot of the currently played clip.
  -  appears when the write-protect switch of the SD card is set.
- 17** Event/Warning Display Area  
Displays error messages.  
(☞ P231 [Error Messages and Actions] )

# Status Screen

For checking the settings of the camera recorder.

## USER Switch Set Screen

For checking the status (functions assigned) of the user buttons.

(P46 [Assignment of Functions to User Buttons])

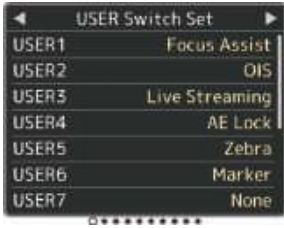

## Camera Screen

For checking information related to shooting using the camera recorder.

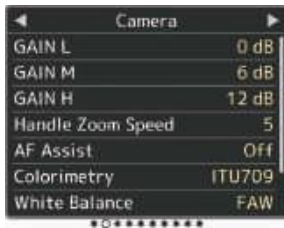

## LCD/VF Screen

For checking information related to the contents displayed on the LCD monitor and viewfinder screens.



## Record Format Screen

For checking settings related to the recording format.



## Audio Screen

For checking the audio settings.

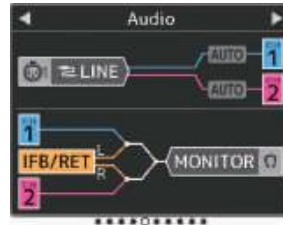

## Video Screen

For checking the settings related to video output.



## Planning Metadata Screen

For checking the current planning metadata setting.

(P187 [ Planning Metadata ])

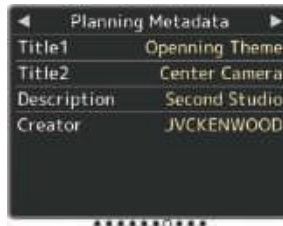

## Network Screen

For checking the network login information.



## Connection Setup Screen

For checking the network connection information.



## Streaming Screen

For viewing information related to live streaming.





# Marker and Safety Zone Displays (Camera Mode Only)

The marker and safety zone displays are useful in helping you determine the angle of view for the image according to the shooting purpose. The marker is displayed only in the Camera mode.

## Displaying the Grid Marker

### 1 Set [LCD/VF] → [Marker Settings] → [Grid Marker] to “On”.

(☞ P127 [ Grid Marker ] )

A grid that divides the screen into 3x3 is displayed.



Memo : \_\_\_\_\_

- When [Grid Marker] is set to “On”, [Aspect Ratio], [Aspect Marker], and [Safety Zone] do not function.
- Example of display when [Aspect Ratio] = “4:3”, [Aspect Marker] = “Line+Halftone”, and [Center Mark] = “On”

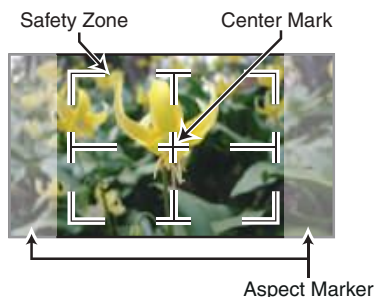

Memo : \_\_\_\_\_

- You can turn On/Off the safety zone and center mark displays using [LCD/VF] → [Marker Settings] → [Aspect Ratio], [Safety Zone], and [Center Mark].  
(☞ P128 [ Safety Zone ] )

## Color Bar Output

Color bars can be output on this camera recorder.

Memo : \_\_\_\_\_

- The audio test signals (1 kHz) can be output simultaneously with the color bar output.  
(☞ P133 [ Test Tone ] )

### To Output the Color Bar Using the Menu

To output color bars, follow the setting procedure below.

#### 1 Set [Camera Function] → [Bars] to “On”.

(☞ P111 [ Bars ] )

Color bars are output.

### To Output the Color Bar Using the User Button

#### 1 Assign the “Bars” function to any of the user buttons.

(☞ P46 [Assignment of Functions to User Buttons] )

#### 2 Press the user button that is assigned with “Bars”.

Color bars are output.

# Adjusting the Gamma

The gamma curve can be adjusted to various characteristics when Color Space is set to a value other than “HLG” and “J-Log1”.

(P118 [ Color Space ])

(P118 [ Gamma ])

- Standard** : Standard gamma curve based on video standard.  
The adjustable level is 0.35 to 0.45 to 0.55 in steps of 0.02.  
When the level is at 0.45, the gamma curve becomes one that conforms to the ITU709 standard.
- Cinema 1** : Sets to a cinema-like gamma curve.  
The level can be adjusted extensively from -5 to 0 to +5.
- Cinema 2** : Sets to a gamma curve with soft expression giving priority to high luminance gradation.  
The level can be adjusted extensively from -5 to 0 to +5.

## HLG and J-Log1 Gamma

The gamma switches automatically to the respective “HLG Gamma” and “J-Log1 Gamma” when [Color Space] is set to “HLG” or “J-Log1”. The HLG Gamma becomes an ITU2100 HLG HDR gamma. Output signals above 100 IRE can be clipped by adjusting “White Clip”. The J-Log1 Gamma becomes a Log gamma with dynamic range of max 800%.

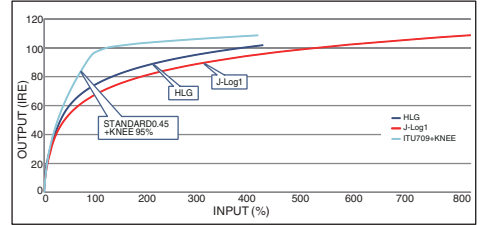

## Gamma Variation

The typical characteristics are shown in the following figure. The figure shows the characteristics when “Standard”, “Cinema 1” or “Cinema 2” is configured and [Knee Level] is set to “95%” for the “Standard” or “Cinema 1” graph.

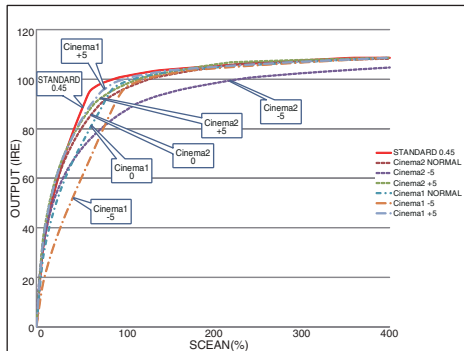

# Adjusting Color Matrix

- The color matrix of the camera recorder can be adjusted to a color of the user's preference.
- When shooting is performed using multiple cameras, the colors of the different cameras can be adjusted, and a color of the user's preference can be set on this camera recorder.
- The Saturation and Hue of the three colors (red, green and blue) can be configured individually.
- Adjust the color on the vector scope and waveform monitor using the DSC color chart.
- \* The adjusted values of "Natural", "Standard", "Cinema Vivid", and "Cinema Subdued" in [Color Matrix] can be stored individually.  
(P122 [ Color Matrix ] )

## 1 Select [Camera Process] ➔ [Color Matrix]/ [Adjust].

(P122 [ Color Matrix ] )

## 2 Adjust Hue.

- Select the color using the cross-shaped button (▲▼) and confirm using the cross-shaped button (▶). (The cursor moves to Hue.)
- Pressing the cross-shaped button (▲) rotates the hue in the clockwise direction on the vector scope.
- Pressing the cross-shaped button (▼) rotates the hue in the anti-clockwise direction on the vector scope.

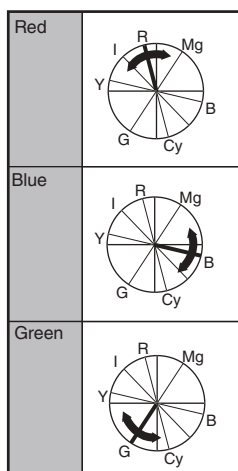

## 3 Adjust Saturation.

- Press the cross-shaped button (▶) to move the cursor to Saturation.
- Each of the colors changes in the direction indicated by the arrow on the vector scope.
- Pressing the cross-shaped button (▲) moves the color outward from the center of the circle on the vector scope.
- Pressing the cross-shaped button (▼) moves the color toward the center of the circle on the vector scope.

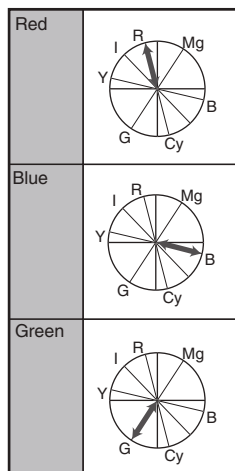

# Configuring Setup Files

The menu settings can be stored on the camera recorder or an SD card by saving them as a setup file.

Loading a saved setup file enables you to reproduce the appropriate setup state speedily. The following types of setup files are available.

- **Picture File:**  
File that contains image creation settings in accordance to the shooting conditions ([Camera Process] menu items).
- **All File:**  
File that contains all menu settings, ranging from video format settings to image creation settings such as device settings and shooting conditions, as well as the contents of the [Favorites Menu]. Settings in Network Settings are not saved.
- **User File:**  
File that contains settings from All File that are not included in the [Camera Process] menu items.  
(☞ P118 [Camera Process Menu] )

Memo : \_\_\_\_\_

- Make use of the [Setup File] menu to save or load a setup file.
- The following operations can be performed on the [Setup File] menu.
  - [Saving Setup Files] (☞ P 173)
  - [Loading a Setup File] (☞ P 174)
  - [Deleting Setup Files] (☞ P 174)
- Even when [Record Format] → [System] is configured to “4K EXT (SSD)”, setup files will be saved to this camera recorder or the SD card.

## Number of Storable Setup Files

Camera recorder	:	[CAM1] to [CAM4]
SD slot A	:	[A 1] to [A 8]
SD slot B	:	[B 1] to [B 8]

## Compatibility

- **User File/All File**
  - Only User File/All File of the GY-HC550 and GY-HC500 series can be loaded.
  - When User File/All File saved using GY-HC550 are loaded using GY-HC500, the functions that only exist on GY-HC550 are ignored.
- **Picture File**  
Only Picture File of the GY-HC550 and GY-HC500 series can be loaded.

## Saving Setup Files

- 1 **Display the [Setup File] menu.**  
Select [System] → [Setup File] and press the Set button (●).  
(☞ P147 [Setup File])
- 2 **Select [Store File] and press the Set button (●).**
- 3 **Select [Picture File], [User File] or [All File], and press the Set button (●).**  
The existing files are displayed.
- 4 **Select the file to be newly saved (or overwritten) using the cross-shaped button (▲▼), and press the Set button (●).**

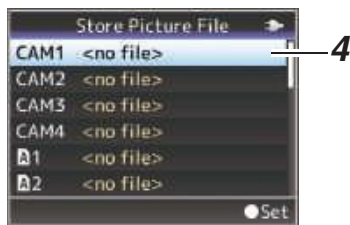

Memo : \_\_\_\_\_

- Files cannot be written in the following cases. (Displayed in gray, selection disabled)
  - When the inserted SD card is not supported or not formatted. (File name appears as “---”.)
  - When a write-protected SD card is inserted (a lock mark appears beside the SD card icon).

### 5 Name the file.

- Enter the surname using the software keyboard.
- (☞ P109 [Text Input with Software Keyboard])
- You can enter up to 8 characters for the [Store File]/[Picture File] surname.

Memo : \_\_\_\_\_

- When overwriting an existing file, the surname of the existing file is displayed.
- Select [Cancel] and press the Set button (●), or press the [CANCEL] button to return to the previous screen.

- 6 **Select [Store] and press the Set button (●).**



- 7 **Save the file.**

- A confirmation screen appears when you choose to overwrite. Select [Overwrite] on the confirmation screen, and press the Set button (●). Saving starts, and “Storing...” appears on the screen.

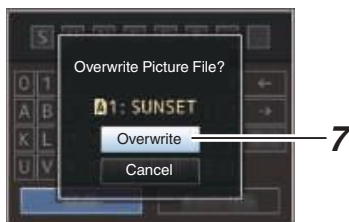

- Saving starts, and “Storing...” appears on the screen when the file is newly saved.



- 8 **Saving is complete.**

After saving of the file is complete, “Complete” appears on the screen, and the menu screen closes automatically.

## Loading a Setup File

- 1 **Display the [Setup File] menu.**  
Select [System] → [Setup File] and press the Set button (●).  
(☞ P147 [ Setup File ])
- 2 **Select [Load File] and press the Set button (●).**
- 3 **Select [Picture File], [User File] or [All File], and press the Set button (●).**  
The existing files are displayed.
- 4 **Select the file to load using the cross-shaped button (▲▼), and press the Set button (●).**



Memo : \_\_\_\_\_

- When the write-protect switch of the inserted SD card is set, a lock icon appears beside the SD card icon. Setup files can be loaded from an SD card even if the write-protect switch is set.
- Setup files that are completely incompatible will not be displayed.  
(☞ P172 [Configuring Setup Files] )

- 5 **Select [Load] on the confirmation screen, and press the Set button (●).**  
Loading starts, and "Loading..." appears on the screen.



- 6 **Reading is complete.**  
After reading of the file is complete, "Complete" appears on the screen, and the menu screen closes automatically.

## Deleting Setup Files

- 1 **Display the [Setup File] menu.**  
Select [System] → [Setup File] and press the Set button (●).  
(☞ P147 [ Setup File ])
- 2 **Select [Delete File] and press the Set button (●).**
- 3 **Select [Picture File], [User File] or [All File], and press the Set button (●).**  
The existing files are displayed.
- 4 **Select the file to delete using the cross-shaped button (▲▼), and press the Set button (●).**



Memo : \_\_\_\_\_

- Setup File saved on the SD card cannot be deleted.

- 5 **Select [Delete] on the confirmation screen, and press the Set button (●).**  
Deletion starts, and "Deleting..." appears on the screen.

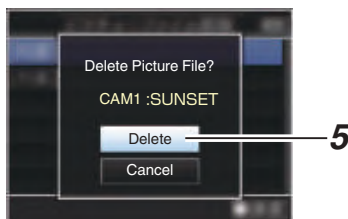

- 6 **Deletion is complete.**  
After file deletion is complete, "Complete" appears on the screen.

# Connecting External Monitor

- To output live or playback video images and audio sound to an external monitor, select the output signals from the camera recorder, and connect using an appropriate cable according to the monitor to be used.
- Choose the most suitable terminal according to the monitor in use.
- [SDI OUT] terminal:  
Outputs either the 3G-SDI/HD-SDI signal or SD-SDI signal.
- [HDMI] terminal:  
Outputs HDMI signals.

Memo :

- If the [SDI OUT] terminal or [HDMI] terminal is connected, configure the settings in the [A/V Set] menu according to the monitor to be connected.  
(☞ P130 [ SDI OUT ] )  
(☞ P131 [ HDMI OUT ] )
- To connect the output signal in the 4K(2160p) setting, use a Premium High Speed HDMI cable (supports 18Gbps).  
When connecting in the 4K(2160p) 59.94p or 50p setting, it is recommended that the cable used does not exceed 2 m.

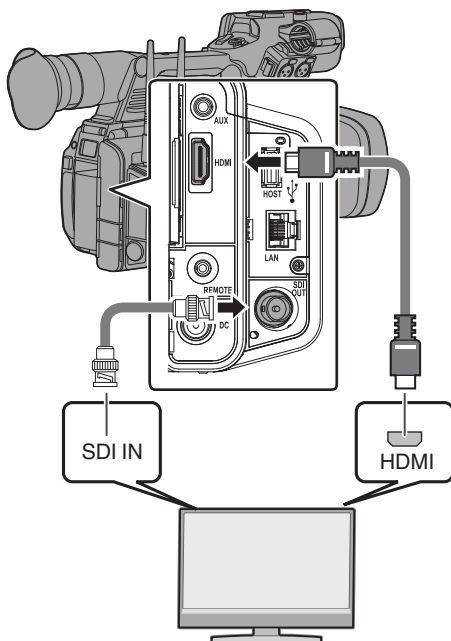

- \* Select the output signal in [A/V Set] → [SDI OUT]/[HDMI OUT].  
(☞ P130 [ SDI OUT ] )  
(☞ P131 [ HDMI OUT ] )
- \* When [Record Format] → [System] is set to “SD”, only SD-SDI signals are output.  
(☞ P149 [ System ] )
- \* To display the menu screen or display screen on the external monitor, set [A/V Set] → [Video Set] → [SDI OUT] → [Character] to “On”.  
(☞ P130 [ Character ] )

## Connecting via SDI

- Digital video signals, together with embedded (superimposed) audio signals and time code signals, are output for both the 3G-SDI/HD-SDI and SD-SDI signals.

Memo :

- The sampling frequency for embedded (superimposed) audio signals is 48 kHz. Time code of the built-in time generator as well as playback time code are also output.

## Connect the headphone.

- Audio output from the [Ⓜ] terminal can be selected using the [A/V Set] → [Monitor] item or the [MONITOR] selection switch on the camera recorder.
- (P134 [ Monitor ])
- The different combinations of settings that are output from the [Ⓜ] terminal and monitor speaker are as follows.

[MONITOR] Selection Switch Setting	[Monitor] Setting	[Ⓜ] Terminal		Speaker *
		L	R	
[CH1]	-	CH1		CH1
[BOTH]	[Mix]	CH1+CH2		CH1+CH2
	[Stereo]	CH1	CH2	
[CH2]	-	CH2		CH2

\* Audio is output from the speaker only in Media mode. Does not output in the Camera mode.

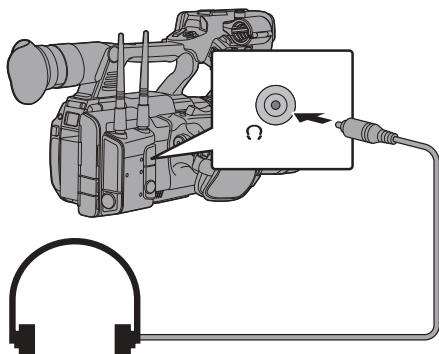

Memo : \_\_\_\_\_

- If both CH1 and CH2 are set to built-in microphone and the [MONITOR] selection switch has been set to "BOTH", stereo sound is output from the [Ⓜ] terminal regardless of the [Monitor] setting.

## Connecting Wired Remote Control

You can operate the functions of this unit with a wired remote control.

Memo : \_\_\_\_\_

- When the switches of the camera recorder and remote control unit are operated at the same time, the switch operation of the remote control unit takes priority over that of the camera recorder.

### 1 Connect a wired remote control to the camera recorder.

Connect the wired remote control (sold separately) to the [REMOTE] terminal of this camera recorder.

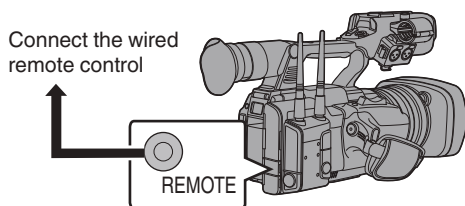

Caution : \_\_\_\_\_

- Turn off the power of the camera recorder when connecting a wired remote control.

### 2 Turn on the power of the camera recorder.



# Functions of Network Connection

The network feature comprises web-browser-based functions using devices such as a smartphone, tablet terminal, or PC, as well as FTP and live streaming functions that run via thumbnail screens and menu operation.

Memo : \_\_\_\_\_

- When [System] → [Record Set] → [Record Format] → [System] is set to “High-Speed”, only “Planning Metadata” can be used for the [LAN] terminal connection.

## Connecting to the Network

- [LAN] Terminal
  - Built-in Wireless LAN **550**
  - Connect the following adapters to the [HOST] terminal (USB)
    - Wireless LAN adapter
    - Ethernet adapter
    - Cellular adapter
- (☞ P178 [Camera Setup for Network Connection] )

## List of Functions

### Importing Metadata

You can download a metadata settings file (XML format) from the FTP server and store metadata in the camera recorder.

(☞ P180 [Importing Metadata] )

### Uploading Recorded Clips

Clips recorded to a recording media can be uploaded to a preconfigured FTP server.

(☞ P182 [Uploading a Recorded Video Clip] )

Memo : \_\_\_\_\_

- Uploading can also be performed via a web browser.  
(☞ P190 [Uploading a Recording Clip via a Web Browser] )

### Editing Metadata

- Planning Metadata  
You can access the page for editing the camera recorder’s metadata via a web browser on devices such as a smartphone, tablet terminal, or PC, and edit the metadata that is to be applied to clips to be recorded.  
(☞ P187 [ Planning Metadata ] )
- Clip Metadata  
You can access the page for editing the metadata via a web browser on devices such as a smartphone, tablet terminal, or PC, and display or rewrite the metadata that is recorded to a clip.  
(☞ P188 [ Clip Metadata ] )

### View Remote

You can access via a web browser on devices such as a smartphone, tablet terminal, or PC to check the live image or remotely control the camera.

(☞ P196 [Camera Control Function] )

Memo : \_\_\_\_\_

- This feature is available when [System] is configured to “HD” or “SD”.

### Camera Control

You can access via a web browser on devices such as a smartphone, tablet terminal, or PC to remotely control the camera.

(☞ P196 [Camera Control Function] )

## Live streaming

By combining with the decoder or PC application that supports live streaming, you can perform audio and video streaming via the network.

(☞ P204 [Performing Live Streaming] )

Memo : \_\_\_\_\_

- This feature is available when [System] is configured to “HD” or “SD”.

## Broadcast Overlay 550 SPC

Texts, images and watermark can be overlaid onto recorded video and live stream video. In addition, changes such as changing the image are possible with the SDP Generator app.

## Scoreboard Overlay SPC

A scoreboard can be overlaid onto a recorded or live streaming video. In addition, changes such as changing the image are possible with the “SDP Generator” app.

## Sports Coaching SPC

This camera recorder supports the tagging feature, which enables information such as the camera angle and actions of an athlete to be recorded in real time as metadata during sports photography or videography.

# Preparing Network Connection

## | Operating Environment

Operation has been verified for the following environments.

### Computer

- OS: Windows 7  
Web browser: Internet Explorer 11
- OS: Windows 10  
Web browser: Chrome
- OS: macOS 10.14  
Web browser: Safari 12

### Smartphone/Tablet Terminal

- OS: iOS11 (iPhone X/iPad Pro)  
Web browser: Safari 11
- OS: Android 8  
Web browser: Chrome

## | Camera Setup for Network Connection

### 1 Connect using the corresponding method of connection

- [LAN] Terminal  
Connect a PC to this camera recorder directly using a cross-over cable or via devices such as an Ethernet hub using a LAN cable.  
(☞ P179 [Wired LAN connection (“LAN” or “USB”-“Ethernet”)] )
- Built-in Wireless LAN 550  
Attach the wireless LAN antenna if it is not mounted.  
(☞ P34 [Attaching the Wireless LAN Antennas (Supplied) 550] )  
(☞ P179 [Wireless LAN connection (“Internal Wireless LAN” 550 or “USB”-“Wireless LAN”)] )
- Connect the following adapters to the [HOST] terminal (USB)
  - Wireless LAN adapter
  - Ethernet adapter
  - Cellular adapter  
(☞ P180 [Cellular adapter connection (“USB”-“Cellular”)] )

Memo : \_\_\_\_\_

- Only a network connection adapter can be connected to the [HOST] terminal (USB).
- Connect or disconnect an adapter only after you have turned off the power of the camera recorder.
- You can find the latest information on the compatible adapters at the product page of our website.
- Two types of network coverage (WAN and LAN) are available for each application.

# Connecting to the Network

## 1 Select the interface in the [Wizard].

- Select “LAN”, “USB” or “Internal Wireless LAN” **550** in [Network] → [Connection Setup] → [Wizard].
- When “USB” is selected, the adapter that is connected to the [HOST] terminal (USB) is recognized and displayed.



## 2 Configure the settings according to the selected interface.

- Wired LAN connection (“LAN” or “USB”-“Ethernet”)

Configure the settings as follows according to the screen.

- IP address setting (DHCP or manual)
- IP Address
- Subnet mask
- Default gateway
- DNS Server

Memo : \_\_\_\_\_

- When an address is manually assigned in a NAT environment, it is also necessary to set the default gateway correctly besides conversion of the address at the router’s end in order to perform operations such as access to the Internet from an external network via the router.

- Wireless LAN connection (“Internal Wireless LAN” **550** or “USB”-“Wireless LAN”)
- When “Connect with Access Point” or “P2P”-“WPS” is selected on the [Select Connection Type] screen.

Configure the settings as follows according to the screen.

- Mode of connection
- Configuration method



- When “P2P”-“Manual” is selected on the [Select Connection Type] screen. Configure the settings as follows according to the screen.
- Mode of connection
- Configuration method



- \* For “P2P”-“Manual” connections, it is necessary to configure the [Passphrase] according to the steps below after the above settings are configured.

- ① Set the camera recorder to the Camera mode, and display [Connection Setup] (status screen).
- Press the [STATUS] button on the camera recorder to display the status screen. Press the cross-shaped button (◀▶) to display [Connection Setup].
- Check to ensure that the [SSID] and [Passphrase] that you have set in the wizard are displayed.

- ② Select [SSID] from the list of access points (smartphone, tablet terminal, PC, etc.), and enter [Passphrase].
  - Display the list of access points in the wireless connection settings of the smartphone, tablet terminal, or PC, and select "HC550-\*\*\*\*\*550" and [HC550-\*\*\*\*\*]500. (\*\*\*\* are numbers that vary with the device used.)
  - After the password confirmation screen appears, enter the [Passphrase] displayed on the [Connection Setup] screen.

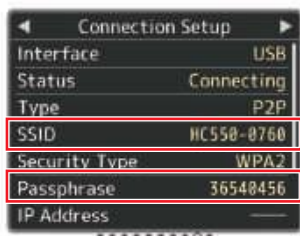

- Cellular adapter connection ("USB"- "Cellular")

Configure the settings as follows according to the screen.

- Connection phone number
- Username
- Password

**Caution :**

- You can access the web functions via a web browser on devices such as a smartphone, tablet terminal, or PC only in a LAN environment.
- Note that you may have to pay very high bills in the case of pay-per-use contracts. Fixed price contract is recommended if you are using the network function.
- Note that the use of improper settings may result in expensive bills from the phone service provider. Make sure that the setting is correct.
- To avoid expensive bills due to the roaming connection, you are recommended to use this function by disabling the roaming contract.
- There may be communication even when you are not using the network function. Remove the cellular adapter when the function is not in use.

**3 Setting is complete.**

After setting is complete, you can access the camera recorder via a web browser.

(☞ P186 [Connecting from a Web Browser])

## Importing Metadata

You can download a metadata settings file (XML format) from the FTP server and store metadata in the camera recorder.

The imported metadata is applied to clips to be recorded.

### Preparing Metadata

- You can record the four metadata types below.

Title1 : ASCII only, max. 63 characters (bytes)  
 Title2 : UNICODE, max. 127 bytes  
 Creator : UNICODE, max. 127 bytes  
 Description : UNICODE, max. 2047 bytes

- Metadata makes use of the XML description format.
- Edit the <Title1><Title2><Description><Creator> tag element using the XML editor. (Indicated by the frames below)

```
<?xml version="1.0" encoding="UTF-8"?>
<NRT-MetaInterface lastUpdate="2015-01-29T18:06:21+09:00"
xmlns="urn:schemas-proHD:nonRealTimeMetaInterface:ver.1.00"
xmlns:xsi="http://www.w3.org/2001/XMLSchema-instance">
  <MetaData>
    <Title1>Title1 sample</Title1>
    <!-- only "en",max63bytes -->
    <Title2>Title2 sample</Title2>
    <!-- ,max127bytes -->
    <Description>Description sample</Description>
    <!-- ,max2047bytes -->
    <Creator>Creator sample</Creator>
    <!-- ,max127bytes -->
  </MetaData>
</NRT-MetaInterface>
```

## Configuring the Server for Downloading

For specifying the settings for connecting to the FTP server for downloading the metadata (domain name, user name, password, etc.) as well as the path of the file to download.

### 1 Open the [Metadata Server] screen.

Open the [Network] → [Metadata Server] screen.

(P142 [Metadata Server Item])

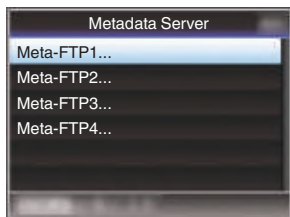

### 2 Register the [Metadata Server].

- Select a server using the cross-shaped button (▲▼), and press the Set button (●). The server settings screen appears. Perform setting for each item.
- Up to 4 settings can be registered.

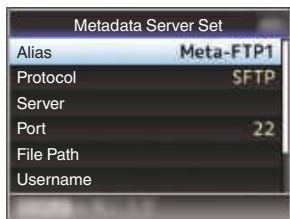

Memo : \_\_\_\_\_

- For details on the registered information, please consult the network administrator for the server.

## Importing Metadata

Download the metadata settings file (XML format) from the FTP server.

### 1 Select [Network] → [Import Metadata] and press the Set button (●).

The [Import Metadata] screen appears.

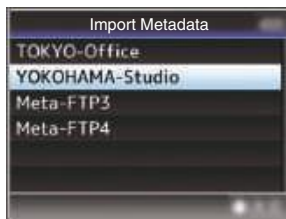

### 2 Select the server for importing the metadata.

- The name that is registered in [Metadata Server] → [Alias] is displayed.
- Select a server using the cross-shaped button (▲▼), and press the Set button (●).



### 3 Select [Import] on the confirmation screen, and press the Set button (●).

Import starts.

After import is complete, the display is restored to the screen before the [Import Metadata] screen appears.

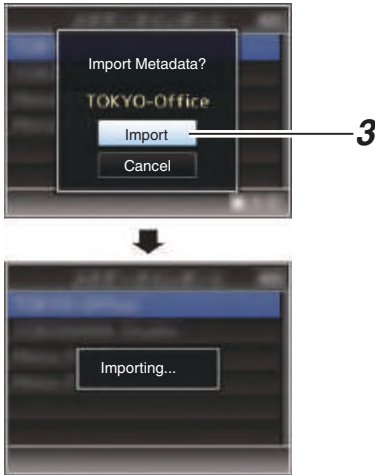

## Uploading a Recorded Video Clip

The following are steps to upload clips recorded in a recording media to a preset FTP server.

### Configuring the FTP Server for Uploading

For specifying the settings for connecting to the FTP server to upload recorded clips to (domain name, user name, password, etc.) as well as the directory of the upload destination.

#### 1 Open the [Clip Server] screen.

Open the [Network] → [Upload Settings] → [Clip Server] screen.

(☞ P143 [ Clip Server ] )



#### 2 Register the [Clip Server].

Register the server to upload recorded clips in the recording media to.

Up to 4 servers can be registered.

Memo : \_\_\_\_\_

- For details on the registered information, please consult the network administrator for the server.

Memo : \_\_\_\_\_

- You cannot exit the menu or perform recording while import is in progress.
- If import of the metadata failed, "Import Error!" is displayed, and a message indicating the cause of the error appears. Press the Set button (●) to return to the [Import Metadata] screen in step 1. (☞ P232 [List of FTP Transfer Errors] )
- When "HTTP" is selected in the [Select FTP Proxy] screen of the network connection setting, connections to the servers other than "FTP" protocol cannot be made.
- If a setting other than "FTP" is specified for [Protocol], to ensure the safety of the communication path, a screen appears prompting you to validate the fingerprint of the public key and certificate received from the server. Check to ensure that the displayed value coincides with the known value.

## Uploading Clips Automatically (Auto FTP)

The following are steps to automatically upload clips recorded in a recording media to a preset FTP server.

### 1 Configure the settings for automatic upload

Configure [Network] → [Upload Settings] → [Upload] to “Auto” and configure the settings for each of [Slot], [Cellular] and [Server].  
(☞ P142 [ Upload ] )



### 2 Start uploading

- Configuring [Network] → [Upload Settings] → [Auto Upload] to “On” starts uploading.
- You can also press the user button that is assigned with “Auto Upload”.

Memo : \_\_\_\_\_

- FTP transfer is performed for the slot configured in [Slot].

- If recording is started for the same slot as the one configured in [Slot] while FTP transfer is in progress, FTP transfer will be interrupted.
- FTP transfer is not performed while live streaming or Return over IP is in progress.
- FTP transfer is disabled when [System] → [Record Set] → [Record Format] → [System] is configured to “High-Speed”. To perform FTP transfer, select a setting other than “High-Speed”.

## Uploading Clips Manually (Manual FTP)

The following are steps to upload clips recorded in a recording media to a preset FTP server. All playable clips on the thumbnail screen can be uploaded.

### 1 Configure the FTP server for manual uploading

Set [Network] → [Upload Settings] → [Upload] to “Manual”.

(☞ P142 [ Upload ] )

### 2 Register the [Clip Server].

- Open the [Network] → [Upload Settings] → [Clip Server] screen.
- Register the server to upload recorded clips in the recording media to.  
Up to 4 servers can be registered.

(☞ P143 [ Clip Server ] )

Memo : \_\_\_\_\_

- For details on the registered information, please consult the network administrator for the server.
- When [Network] → [Upload Settings] → [Upload] is configured to “Auto”, manual uploading is also disabled for slots other than the selected “Slot”. To perform manual uploading, select “Manual”.
- FTP transfer is disabled when [System] → [Record Set] → [Record Format] → [System] is configured to “High-Speed”. To perform FTP transfer, select a setting other than “High-Speed”.

## Uploading a Video Clip

### 1 Set the camera recorder to the Media mode.

- Press and hold the [MODE] selection button in the Camera mode to enter the Media mode. A thumbnail screen of the clips recorded on the recording media is displayed.
- You can upload the selected clips on the thumbnail screen to the FTP server.

(☞ P97 [Thumbnail Screen] )

- 2 Move the cursor to the clip to be uploaded.**  
Move the cursor to the clip to be uploaded using the cross-shaped button (▲▼◀▶).



- 3 Press the [ONLINE/3] button.**  
The action selection screen is displayed.

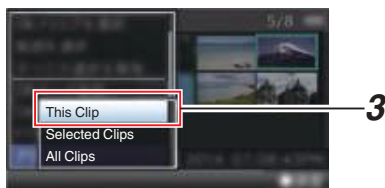

- 4 Select [FTP Upload] → [This Clip] → server to upload to, and press the Set button (●).**  
The status of the transfer process is indicated by a progress bar.



Memo : \_\_\_\_\_

- The name for the server to upload files to are indicated using the preset names in [Clip Server] → [Alias].
- To stop uploading, press the Set button (●). Select [Yes] on the confirmation screen, and press the Set button (●) to stop uploading and return to the thumbnail screen.

- 5 Upload is complete.**
- After upload is complete, “Successfully Completed.” appears on the screen.
  - Press the Set button (●) to return to the thumbnail screen.

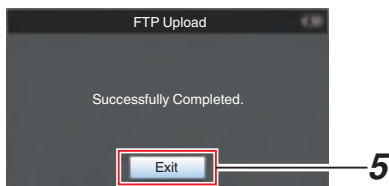

### Selecting and Uploading Multiple Clips

To select and upload multiple clips, refer to “[Selecting and Performing Operations on Multiple Clips] (P 104)”.

### Uploading All Video Clips

- 1 Press the [ONLINE/3] button.**  
The action selection screen is displayed.
- 2 Upload the clips.**  
Select [FTP Upload...] → [All Clips] → server to upload to, and press the Set button (●).

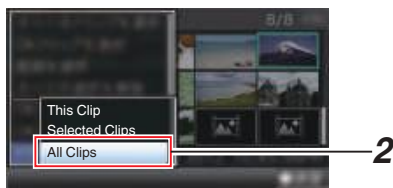

- 3 Upload starts.**  
The status of the transfer process is indicated by a progress bar.





Memo : \_\_\_\_\_

- To stop uploading, press the Set button (●). Select [Yes] on the confirmation screen, and press the Set button (●) to stop uploading and return to the thumbnail screen.
- If the file to be uploaded has the same name as an existing file in the FTP server, an overwrite confirmation window appears.
- When “HTTP” is selected in the [Select FTP Proxy] screen of the network connection setting, the overwrite confirmation window will not be displayed and the existing file is overwritten.
- Even after upload has started (FTP transfer in progress) in step 3, pressing the [MODE] button switches the camera recorder to the Camera mode, allowing you to start shooting.
- If a setting other than “FTP” is specified for [Protocol], to ensure the safety of the communication path, a screen appears prompting you to validate the fingerprint of the public key and certificate received from the server.  
Check to ensure that the displayed value coincides with the known value.
  - Fingerprint is a unique value that varies with each public key and certificate.
  - For details of the fingerprint, please consult the administrator of the server to be connected.

(☞ P143 [ Clip Server ] )

- When “HTTP” is selected in the [Select FTP Proxy] screen of the network connection setting, connections to the servers other than “FTP” protocol cannot be made.

#### 4 Upload is complete.

- After all clips are uploaded successfully, “Successfully Completed.” is displayed. Press the Set button (●) to return to the thumbnail screen.
- When clips are not uploaded successfully, the following errors are displayed.

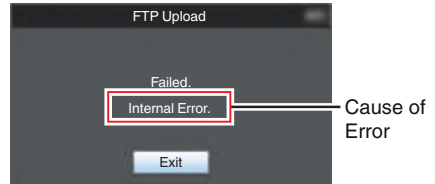

(☞ P232 [List of FTP Transfer Errors] )

Memo : \_\_\_\_\_

- If a notification such as an error message appears after shifting to the Camera mode while FTP transfer is in progress, a ● icon (yellow) will appear in the media's remaining level display area in the Camera mode. You can press the [MODE] button to switch to the Media mode and display the above error screen. Follow “[List of FTP Transfer Errors] (☞ P 232)” to clear the error message.

# FTP Resume Feature

When FTP transfer starts and there is a file of the same name on the server with a file size smaller than the file to be transferred, the file on the server will be regarded as an interrupted file during a FTP transfer. A confirmation screen to resume transfer (append writing) appears.

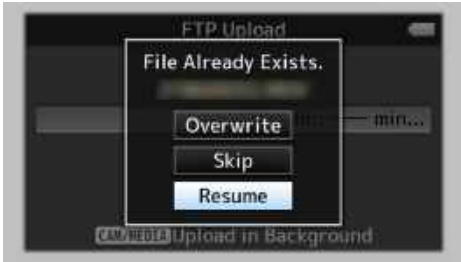

If "Resume" is selected, FTP transfer is carried out such that it appends from the position where it was interrupted. When FTP transfer ends normally, "Complete" appears on the screen.

Memo : \_\_\_\_\_

- FTP server equipped with resume function is required.
- If [Network] → [Upload Settings] → [Clip Server] → [Clip-FTP1/2/3/4] → [Protocol] is set to "SFTP", the resume function is disabled.
- If "HTTP" is selected in the [Select FTP Proxy] screen of the network connection setting, the resume function is disabled.

# Connecting from a Web Browser

You can access the web functions of this camera recorder via a web browser on devices such as a smartphone, tablet terminal, or PC. Make the necessary preparations for connection in advance.

(☞ P178 [Camera Setup for Network Connection] )

### 1 Set the camera recorder to the Camera mode, and display [Connection Setup] (status screen).

- Press the [STATUS] button on the camera recorder to display the status screen. Press the cross-shaped button (◀▶) to display the [Connection Setup] screen.
- Check the displayed [IP Address].

### 2 Start up the web browser on the terminal you wish to connect to the camera recorder, and enter the [IP Address] in the address field.

(Example: 192.168.0.10)

If "192.168.0.10" is displayed in [IP Address], enter "http://192.168.0.10".

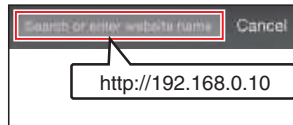

### 3 Enter the user name and password.

Enter the user name and the password on the login screen to display the main page of the camera.

- Check the [Web Username] and [Web Password] in the [Network] screen (status screen).

Memo : \_\_\_\_\_

- The user name and password can be changed in [Network] → [Web] → [Username] and [Password].  
(☞ P141 [ Username ] )  
(☞ P141 [ Password ] )

# Editing Metadata

You can create the metadata to be inserted into a recorded file, or rewrite the metadata of a recorded clip.

## Planning Metadata

You can access the page for editing the camera recorder's metadata via a web browser on devices such as a smartphone, tablet terminal, or PC, and edit the metadata that is to be applied to clips to be recorded.

- 1 Access the main page of the camera.**  
Access the page via a web browser on devices such as a smartphone, tablet terminal, or PC. (P186 [Connecting from a Web Browser])
- 2 Tap (click) the [Planning Metadata] tab to open the [Planning Metadata] screen.**



### 3 Edit the metadata.

- ① Enter information for the necessary fields.
- ② After input is complete, tap (click) [Save] to overwrite the metadata.

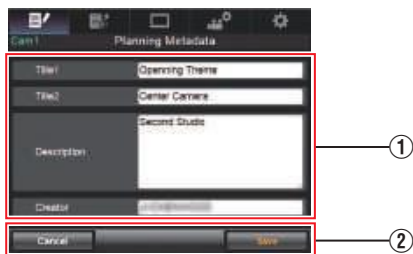

### 4 Tap (click) [OK] on the confirmation screen.

- Update of the [Planning Metadata] starts.
- After update is complete, "Renewal of planning metadata is succeeded." is displayed. Tap (click) [OK].
- Returns to the screen in step 3.

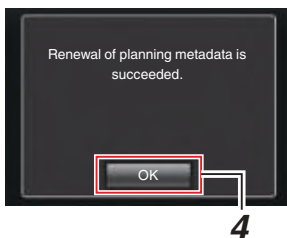

Memo : \_\_\_\_\_

- If update failed, "Renewal of planning metadata is failed." is displayed. Tap (click) [Close] to return to the screen of step 3.

## Clip Metadata

You can access the page for editing the metadata via a web browser on devices such as a smartphone, tablet terminal, or PC, and display or rewrite the metadata that is recorded to a clip.

### 1 Access the main page of the camera.

Access the page via a web browser on devices such as a smartphone, tablet terminal, or PC. (P186 [Connecting from a Web Browser])

### 2 Display the clip list.

Tap (click) the [Clip List] tab to display the clip list.



## Switching from a web browser

- 1 You will see a message indicating "It is necessary to change the camera mode to "Remote Edit Mode". Change the mode." on the web browser.

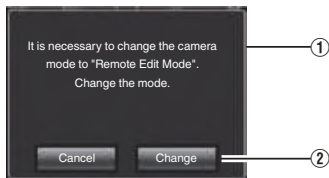

- 2 Tap (click) [Change] to switch the camera to the Remote Edit mode.

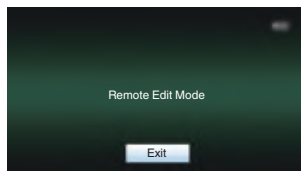

## Switching from the camera

- 1 "Change to Remote Edit Mode?" is displayed on the display screen of the camera unit.
- 2 Select [Change] and press the Set button (●) to switch to the Remote Edit mode.

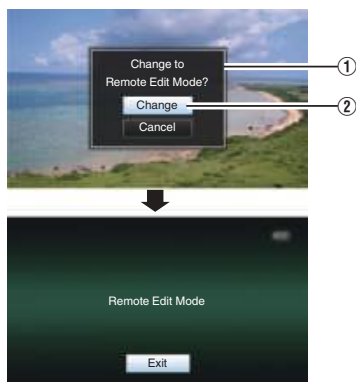

Memo : \_\_\_\_\_

- When the menu or status is displayed, display of the confirmation screen will be put on hold.
- If the menu is displayed on the camera recorder, close the menu.
- If the status is displayed on the camera recorder, close the status display.
- Pressing the Set button (●) on the camera recorder while in the Remote Edit Mode ends the Remote Edit Mode forcibly and switches to the Camera mode.
- When FTP upload via the camera unit is currently in progress, switching to the Remote Edit mode is disabled.

#### 4 Select the Metadata Edit mode.

Select the [Metadata] tab.

#### 5 Select the clip to rewrite the metadata.

- A list of the recorded clips appears on the [Clip List] screen.
- Tap (click) the clip for which you want to rewrite the metadata.



## 6 Edit the metadata of the selected clips.

- 1 Edit the information for the necessary fields.
  - If you are using a PC, input using the mouse and keyboard.
  - If you are using a smartphone or tablet terminal, tap the text input area to display a standard software keyboard on the screen. Enter the information using the displayed keyboard.
- 2 You can tap (click) [OK Mark] to add an OK mark to or delete it from selected clips.
- 3 After editing is complete, tap (click) [Save] to overwrite the metadata.



Memo : \_\_\_\_\_

- You can switch the displayed slot using the [Slot A] and [Slot B] tabs. The [Slot EXT] tab appears when [System] is configured to “4K EXT (SSD)”.
- You can use the [▲-30] or [▼+30] tab to jump to the previous or next 30 clips on the list.

- 7 Tap (click) [OK] on the confirmation screen.
- Update of the metadata starts.
  - After update is complete, “Renewal of clip metadata is succeeded.” is displayed. Tap (click) [OK].
  - Returns to the screen in step 4.



7

Memo : \_\_\_\_\_

- If update failed, “Renewal of clip metadata is failed.” is displayed. Tap (click) [Close] to return to the screen of step 4.

## Uploading a Recording Clip via a Web Browser

- The following are steps to upload clips recorded in a recording media to a preset FTP server.
- You can upload selected clips, all clips, or those appended with an OK mark.

### Configuring the FTP Server for Uploading

(☞ P182 [Configuring the FTP Server for Uploading] )

### Uploading Video Clips

- 1 Access the main page of the camera.**  
Access the page via a web browser on devices such as a smartphone, tablet terminal, or PC. (☞ P186 [Connecting from a Web Browser] )
- 2 Display the clip list.**  
Tap (click) the [Clip List] tab to display the clip list.



- 3 Set the camera recorder to the “Remote Edit Mode”.**

You can switch to “Remote Edit Mode” from a web browser or through operation of the camera.

■ Switching from a web browser

- ① You will see a message indicating "It is necessary to change the camera mode to "Remote Edit Mode". Change the mode." on the web browser.

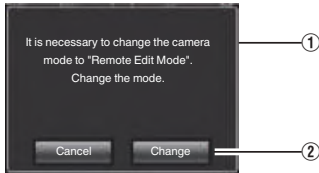

- ② Tap (click) [Change] to switch the camera to the Remote Edit mode.

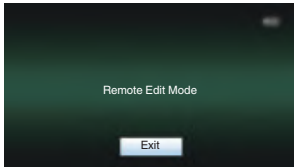

■ Switching from the camera

- ① "Change to Remote Edit Mode?" is displayed on the display screen of the camera unit.
- ② Select [Change] and press the Set button (●) to switch to the Remote Edit mode.

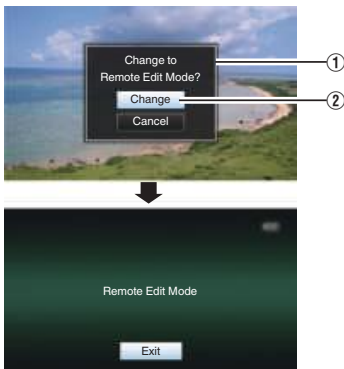

Memo : \_\_\_\_\_

- When the menu or status is displayed, display of the confirmation screen will be put on hold.
- If the menu is displayed on the camera recorder, close the menu.
- If the status is displayed on the camera recorder, close the status display.
- Pressing the Set button (●) on the camera recorder while in the Remote Edit Mode ends the Remote Edit Mode forcibly and switches to the Camera mode.
- When FTP upload via the camera unit is currently in progress, switching to the Remote Edit mode is disabled.

4 Select the Upload mode.

Select the [Upload] tab.

5 Select the clip you want to upload.

- A list of the recorded clips appears on the [Clip List] screen.
- Tap (click) the clip you want to upload to select it.
- Clips being selected are indicated by a check mark.

Memo : \_\_\_\_\_

- You can switch the displayed slot using the [Slot A] and [Slot B] tabs. The [Slot EXT] tab appears when [System] is configured to "4K EXT (SSD)".
- You can use the [▲-30] or [▼+30] tab to jump to the previous or next 30 clips on the list.

6 Select the upload operation.

Tap (click) the [Actions] button.

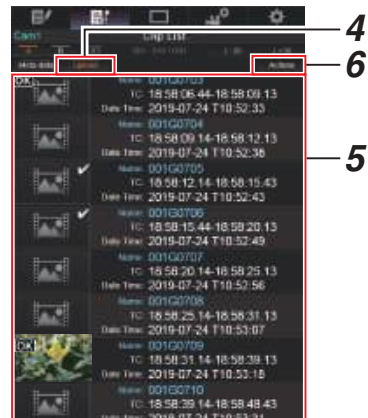

## 7 Select a method to upload the clips.

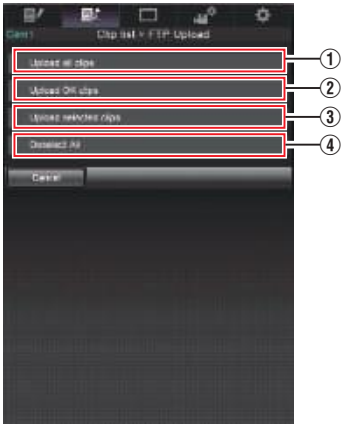

- ① Upload all clips  
Uploads all the clips in the displayed slots.  
Tap (click) to move to the [Clip Server] screen.
- ② Upload OK clips  
Uploads all clips in the displayed slots that are appended with an OK mark.  
Tap (click) to move to the [Clip Server] screen.
- ③ Upload selected clips  
Uploads the clips you have selected.  
Tap (click) to move to the [Clip Server] screen.
- ④ Clear all selection  
Clears all clip selection and returns to the [Clip List] screen.

## 8 Select the clip server and start uploading.

- Upon selecting the server to upload clips to, an upload screen appears.

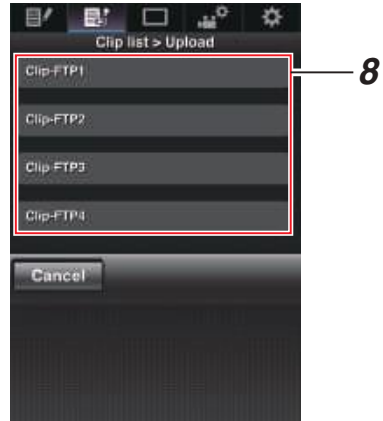

- The status of the transfer process is indicated by a progress bar.





Memo : \_\_\_\_\_

- To stop transfer, tap (click) the [Stop] button. Tapping (clicking) [Yes] on the confirmation screen stops the transfer halfway and brings you back to the main page.
- If there already exists a file on the FTP server with a name identical to the file to be transferred, a confirmation screen asking to overwrite the file will appear. However, if “HTTP” is selected in the [Select FTP Proxy] screen of the network connection settings, an overwrite confirmation screen does not appear, and the existing file will be overwritten directly.
- After uploading in step 8 has started, other web browser operations are disabled until uploading is complete.
- After uploading in step 8 has started and upon shifting to the Media mode by pressing the [[MODE] selection button, operation from the web browser will be disabled. To enable web browser operation, press the [[MODE] selection button again to switch to the Camera mode.
- If a setting other than “FTP” is specified for [Protocol], to ensure the safety of the communication path, a screen appears prompting you to validate the fingerprint of the public key and certificate received from the server.  
Check to ensure that the displayed value coincides with the known value.
  - Fingerprint is a unique value that varies with each public key and certificate.
  - For details of the fingerprint, please consult the administrator of the server to be connected.(☞ P143 [ Clip Server ] )
- When “HTTP” is selected in the [Select FTP Proxy] screen of the network connection setting, connections to the servers other than “FTP” protocol cannot be made.

## 9 Upload is complete.

- After upload is complete, “Successfully Completed.” appears on the screen.

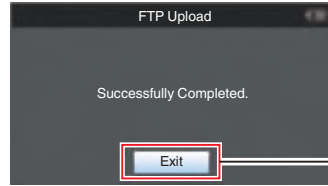

- When clips are not uploaded successfully, the following errors are displayed.

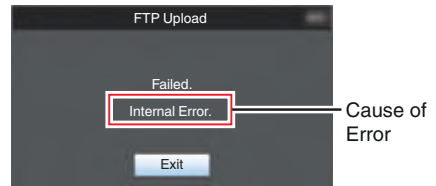

(☞ P232 [List of FTP Transfer Errors] )

Memo : \_\_\_\_\_

- Follow “[List of FTP Transfer Errors] (☞ P 232)” to clear the error message.

# View Remote Feature

You can access via a web browser on devices such as a smartphone, tablet terminal, or PC to check the live image and perform the following remote control operations.

- Start/stop recording
- Zooming
- Register/delete preset zoom

## 1 Access the main page of the camera.

Access the page via a web browser on devices such as a smartphone, tablet terminal, or PC. (☞ P186 [Connecting from a Web Browser])

## 2 Tap (click) the [View Remote] tab to open the [View Remote] screen.



## Operating Procedure



- 1 Page Switch Tab**  
Tap (click) this tab to move to the [Planning Metadata], [Clip Metadata], or [Settings] screen.
- 2 Live View Screen**  
Displays the live images.  
Tap a live image to display or hide information that is displayed on the live image, such as remaining space on the media and time code.
- 3 [Clear] Button**  
Switches to the Delete Preset Zoom Position mode.  
(☞ P195 [Registering/Deleting Preset Zoom])  
(☞ P196 [Deleting a Preset Zoom])
- 4 [Preset] Button**  
Switches to the Register Preset Zoom Position mode.  
(☞ P195 [Registering Preset Zoom])
- 5 Zoom Control**
  - Operate the zoom function by dragging the zoom button along the sliding bar.
  - Tap (click) the [Wide] or [Tele] button to fine-tune the zoom position.
  - The slide changes according to the dynamic zoom.



Dynamic Zoom On:



- 6 Start Record Button**
  - 7 Stop Record Button**
  - 8 [A]/[B]/[C] Buttons**  
Use these buttons to perform preset registration or delete a preset data.
  - 9 Function Lock Button**  
Locks the functions that have been set on the [Settings] screen.  
(☞ P199 [Changing View Remote Function Settings])
- | Icon | Description |
|------|-------------|
|      | Locked      |
|      | Not locked  |
- 10 Camera Control Function**  
(☞ P196 [Camera Control Function])

## Registering/Deleting Preset Zoom

### Registering Preset Zoom

You can register any 3 zoom positions.

#### 1 Set to the Register Preset Zoom mode.

Tap (click) the [Preset] button to switch to the Register Preset Zoom mode.

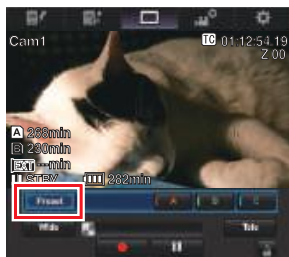

#### 2 Determine the zoom position.

Use the zoom control to operate the zoom and determine a position.

#### 3 Tap (click) [A].

Position [A] is registered, and position A is displayed on the sliding bar of the zoom control.

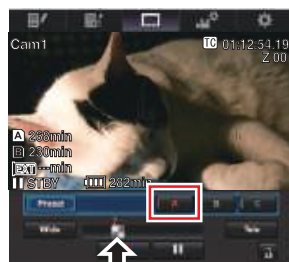

#### 4 In the same way, register [B] and [C].

After all three positions A, B and C are registered, the positions of the [A], [B], and [C] buttons will be rearranged according to the order of the registered zoom position from the left.

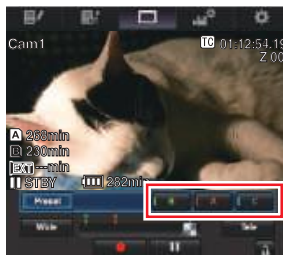

#### 5 Exit the Register Preset Zoom mode.

Tap (click) the [Preset] button to exit the Register Preset Zoom mode.

Memo :

- After registration is complete ([A], [B], and [C] buttons are all active), tapping (clicking) each button switches to the corresponding preset zoom position.
- This function operates independently of the preset zoom position on the camera recorder. (P59 [Saving/Recalling Current Zoom Position (Preset Zoom)])
- When the dynamic zoom is on, the preset button where the dynamic zoom position is registered grays out when the dynamic zoom is off and the zoom position cannot be changed.
- When the dynamic zoom is off, the dynamic zoom position cannot be registered.

## Deleting a Preset Zoom

### 1 Set to the Delete Preset Zoom mode.

When any of positions [A], [B], and [C] are registered, tapping (clicking) the [Clear] button switches to the Delete Preset Zoom mode.

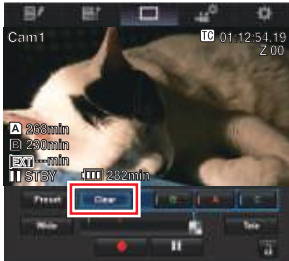

### 2 Tap (click) the [A], [B], or [C] button that corresponds to the position you want to delete.

- The position is deleted, and the button is grayed out.
- The corresponding zoom position mark on the sliding bar also disappears.



Grayed out  
Position mark  
disappears

### 3 Exit the Delete Preset Zoom mode.

Tap (click) the [Clear] button to exit the Delete Preset Zoom mode.

Memo :

- The Clip Review function of the camera recorder is unavailable during View Remote operation. (P86 [Viewing Recorded Videos Immediately (Clip Review)])

## Camera Control Function

You can control the camera by accessing via a web browser on devices such as a smartphone, tablet terminal, or PC.

You can perform the following operations for each of the items.

The image is displayed on the View remote.



### 1 REC

For performing recording start or recording pause operation.



### 2 STREAMING

Turns on or off live streaming.

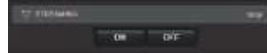

- 3 CAMERA**  
Enables operations related to the camera functions.



- 4 ZOOM**  
Enables zooming operations.



- 5 FOCUS**  
Enables focusing operations.



- 6 USER SWITCH**  
You can enable or disable the user buttons that are assigned with a function.



- 7 MENU**  
You can show or hide the display and menu characters on an external monitor as well as operation of menus, switching the display screen and status display.



# Changing the Settings via a Web Browser

You can change the network-related settings by accessing via a web browser on devices such as a smartphone, tablet terminal, or PC.

## 1 Access the main page of the camera.

Access the page via a web browser on devices such as a smartphone, tablet terminal, or PC. (P186 [Connecting from a Web Browser])

## 2 Tap (click) the [Settings] tab.



## 3 The [Settings] screen appears.

Set each of the items as follows.



1 View Remote  
Settings for operations on the View Remote.

2 Connection Setup  
Settings related to the network.  
You can change the settings for each of the preset items on the [Wizard] screen of the camera recorder.

3 Metadata Server  
Settings on the server for importing the metadata.  
Setting can be performed in the same way as the Metadata Server menu on the camera recorder.  
The latest settings are reflected, regardless of whether they are specified via the camera recorder or web operation.

4 Clip Server  
Settings for the server to upload recorded clips to.  
Setting can be performed in the same way as the [Clip Server] menu on the camera recorder.  
The latest settings are reflected, regardless of whether they are specified via the camera recorder or web operation.

5 Live Streaming  
Setting for streaming audio and video via the network.  
The latest settings are reflected, regardless of whether they are specified via the camera recorder or web operation.

6 Return over IP  
For specifying settings related to Return over IP. For configuring settings for receiving video and audio via the network.  
The latest settings are reflected, regardless of whether they are specified via the camera recorder or web operation.

Memo : \_\_\_\_\_

- Priority is given to menu operation on the camera recorder.
- When the menu on the camera recorder is opened while the [Settings] screen is opened using a web browser, a warning appears, after which the display returns to the main screen.
- While the menu is displayed on the camera recorder, the [Settings] screen cannot be opened via the web browser.

## Changing View Remote Function Settings

For performing setting for using the View Remote function.

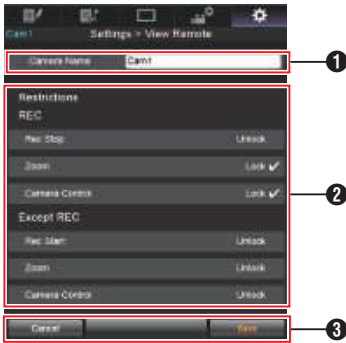

### 1 [Camera Name]

- For setting the name that appears at the top left of the view screen.
- Tapping the text input area displays a software keyboard. If you are using a PC, enter using the PC keyboard.
- By tapping the Go key after input is complete, the software keyboard disappears.

### 2 [Restrictions]

For setting the buttons to be disabled on the View screen while in the locked mode.

- [REC]:  
For setting whether to disable the Stop Record button, zoom operation, and camera control during recording. Tap (click) each item to switch between [Unlock] and [Lock].
- [Except REC]:  
For setting whether to disable the record button, zoom operation, and camera control in any mode other than the recording mode. Tap (click) each item to switch between [Unlock] and [Lock].

### 3 [Save]/[Cancel]

Tap (click) [Save] to save the settings.  
Tap (click) [Cancel] to stop setting and return to the main [Settings] screen.

## Changing Connection Setup

You can change the settings for each of the preset items on the [Wizard] screen of the camera recorder.

- If all the items cannot be displayed in a single page, scroll down to display the remaining items.
- Items that cannot be changed are grayed out according to the type of adapter connected and the mode of connection.



### 1 Method of Connection

### 2 Type of USB Adapter Connected

### 3 Mode of Wireless LAN Connection

### 4 [Search Access Point] Button

Tap (click) to display a list of the detected access points.

The currently selected access point is indicated by a dot mark (•).

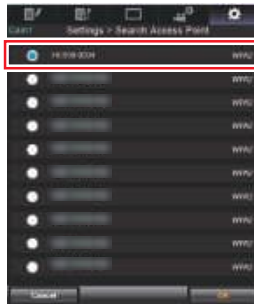

### 5 Settings on the [Select Setup Type] Screen of the Camera Recorder



- 6 Settings on the [IP Address Configuration] Screen of the Camera Recorder  
When “On” is selected for “DHCP”, all items will be grayed out.



- 7 Settings when using cellular adapter



- 8 Settings on the [Select FTP Proxy] Screen of the Camera Recorder  
9 [OK]/[Cancel] Button  
After changing of settings is complete, tap (click) the [OK] button.  
On the confirmation screen, tap (click) [Execute] to change the settings on the camera recorder and restart the network.

## Changing Metadata Server Settings

You can make direct changes to the FTP server for importing the metadata set in [Network] → [Metadata Server], as well as the path of the file to import.  
(☞ P142 [Metadata Server Item] )

## Changing Clip Server Settings

You can make direct changes to the server and directory settings that are specified in [Network] → [Clip Server] for uploading recorded clips in the recording media to the FTP server.  
(☞ P143 [ Clip Server ] )

## Changing Streaming Settings

You can make direct changes to settings that are specified in [Network] → [Live Streaming], such as information on the destination of distribution.  
(☞ P137 [Live Streaming Item] )



# Managing the Network Connection Settings File

This camera recorder allows you to save the network connection settings on the Wizard screen to the camera recorder unit.

Loading a saved connecting settings file enables you to reproduce the appropriate network connection state speedily.

Memo : \_\_\_\_\_

- To save or retrieve the connection settings, go to [Network] → [Connection Setup].
- The following operations can be performed on the [Connection Setup] menu.
  - [Saving the Connection Settings File] (P 201)
  - [Reading the Connection Settings File] (P 202)
  - [Deleting Connection Settings] (P 203)

## Number of Storable Setup Files

Camera recorder : [CAM1] to [CAM4]

## | Saving the Connection Settings File

- 1 Select [Network] → [Connection Setup] → [Setup File] and press the Set button (●).
- 2 Select [Store] and press the Set button (●).



- 3 Select the file to be newly saved (or overwritten) using the cross-shaped button (▲▼), and press the Set button (●).



- 4 **Name the file.**  
Enter the subname using the software keyboard.  
(P 109 [Text Input with Software Keyboard])

Memo : \_\_\_\_\_

- When overwriting an existing file, the subname of the existing file is displayed.
- Select [Cancel] and press the Set button (●), or press the [CANCEL] button to return to the previous screen.

5 Select [Store] and press the Set button (●).



6 Save the file.

- A confirmation screen appears when you choose to overwrite. Select [Overwrite] on the confirmation screen, and press the Set button (●). Saving starts, and “Storing...” appears on the screen.

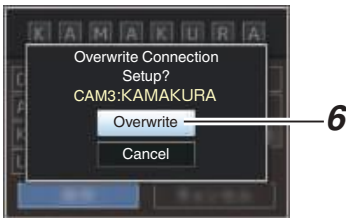

- Saving starts, and “Storing...” appears on the screen when the file is newly saved.



7 Saving is complete.

After saving of the file is complete, “Complete” appears on the screen, and the menu screen closes automatically.

## Reading the Connection Settings File

- 1 Select [Network] → [Connection Setup] → [Setup File] and press the Set button (●).
- 2 Select [Load] and press the Set button (●).

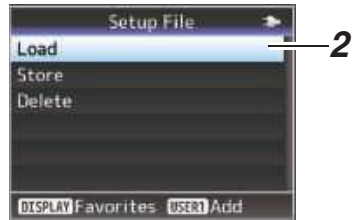

- 3 Select the file to read using the cross-shaped button (▲▼), and press the Set button (●).



- 4 Select [Load] on the confirmation screen, and press the Set button (●). Loading starts, and “Loading...” appears on the screen.

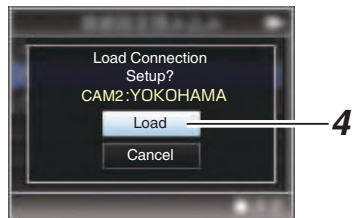

5 Reading is complete.

After reading of the file is complete, “Complete” appears on the screen, and the menu screen closes automatically.

## Deleting Connection Settings

- 1 Select [Network] → [Connection Setup] → [Setup File] and press the Set button (●).
- 2 Select [Delete] and press the Set button (●).

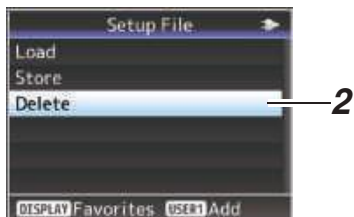

- 3 Select the file to delete using the cross-shaped button (▲▼), and press the Set button (●).



- 4 Select [Delete] on the confirmation screen, and press the Set button (●).  
Deletion starts, and "Deleting..." appears on the screen.

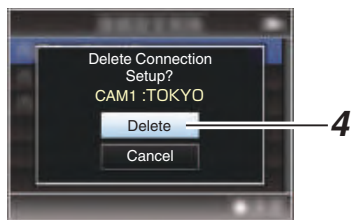

- 5 **Deletion is complete.**  
After file deletion is complete, "Complete" appears on the screen.

# Performing Live Streaming

By combining with the decoder or PC application that supports live streaming, you can perform audio and video streaming via the network.

## Supported Formats

Record Format				Usable Formats for Live Streaming							
System	Format	Resolution	Frame Rate	1920x1080, 60p	1920x1080, 60i	1920x1080, 30p	1280x720, 60p	1280x720, 30p	720x480, 60i	640x360, 60p	640x360, 30p
HD	QuickTime (H.264)	1920x1080	60p	✓	✓	✓	✓	✓	✓	✓	✓
			60i	-	✓	✓	✓	✓	✓	✓	✓
			30p	-	-	✓	-	✓	-	-	✓
	Exchange (U model)	1280x720	60p	-	-	-	✓	✓	✓	✓	✓
			60p	-	-	-	✓	✓	✓	✓	✓
	QuickTime (MPEG2) MXF (MPEG2) 550	1920x1080	60i	-	✓	✓	✓	✓	✓	✓	✓
			30p	-	-	✓	-	✓	-	-	✓
		1440x1080	60i	-	✓	✓	✓	✓	✓	✓	✓
			1280x720	60p	-	-	-	✓	✓	✓	✓
SD (U model)	QuickTime (H.264)	720x480	60i	-	-	-	-	-	✓	-	-

Record Format				Usable Formats for Live Streaming							
System	Format	Resolution	Frame Rate	1920x1080, 50p	1920x1080, 50i	1920x1080, 25p	1280x720, 50p	1280x720, 25p	720x576, 50i	640x360, 50p	640x360, 25p
HD	QuickTime (H.264)	1920x1080	50p	✓	✓	✓	✓	✓	✓	✓	✓
			50i	-	✓	✓	✓	✓	✓	✓	✓
			25p	-	-	✓	-	✓	-	-	✓
	MP4 (E model)	1280x720	50p	-	-	-	✓	✓	✓	✓	✓
			50p	-	-	-	✓	✓	✓	✓	✓
	QuickTime (MPEG2) MXF (MPEG2) 550	1920x1080	50i	-	✓	✓	✓	✓	✓	✓	✓
			25p	-	-	✓	-	✓	-	-	✓
		1440x1080	50i	-	✓	✓	✓	✓	✓	✓	✓
			1280x720	50p	-	-	-	✓	✓	✓	✓
SD (E model)	QuickTime (H.264)	720x576	50i	-	-	-	-	-	✓	-	-

Memo : \_\_\_\_\_

- The distributable resolution, frame rate and bit rate vary according to the recording format.
  - To distribute progressive video, set the frame rate to any of the progressive frame rates. And to distribute interlace video, set the frame rate to any of the interlace frame rates.
  - Depending on the type of network adapter used and the connection, the images and audio sound during live streaming can be choppy.
- 

## Audio

AAC

## Supported Protocols

MPEG2-TS/UDP  
MPEG2-TS/TCP  
MPEG2-TS/RTP  
RTSP/RTP  
ZIXI  
RTMP

## Setting Distribution

### 1 Set the [Record Format] according to the resolution and frame rate of the video to be distributed.

For details on the [Record Format] settings, please refer to [Distributable [Record Format] and [Live Streaming Set] Combinations] (P 206).

Memo : \_\_\_\_\_

- Live streaming cannot be performed in the following cases.
  - When [System] → [Record Set] → [Record Format] → [System] is set to other than “HD” or “SD”
  - When [System] → [Record Set] → [Record Format] → [Frame Rate] is set to “24p”

### 2 Set the Resolution and Frame & Bit Rate for the video to be distributed.

Specify the settings in [Network] → [Live Streaming].  
(P137 [Live Streaming Item])

### 3 Specify the distribution protocol and related items.

Specify the distribution protocol and related items in [Network] → [Live Streaming] → [Streaming Server].  
(P137 [Streaming Server])

### 4 Select the server for live streaming.

Select the distribution server in [Network] → [Live Streaming] → [Server].

## Distributable [Record Format] and [Live Streaming Set] Combinations

Resolution	1920 x 1080						1280 x 720											
	60p, 50p			60i, 50i, 30p, 25p			60p, 50p			30p, 25p								
Type	MPEG2-TS/UDP	MPEG2-TS/TCP	MPEG2-TS/RTP	RTSP/RTP	ZIXI	RTMP	MPEG2-TS/UDP	MPEG2-TS/TCP	MPEG2-TS/RTP	RTSP/RTP	ZIXI	RTMP	MPEG2-TS/UDP	MPEG2-TS/TCP	MPEG2-TS/RTP	RTSP/RTP	ZIXI	RTMP
Bit Rate																		
24 Mbps	■																	
20 Mbps	■	■					▲						▲					
16 Mbps	■	■	■				▲	▲					▲	▲				
12 Mbps	■	■	■	■			●	●					●	●				
8 Mbps	■	■	■	■			●	●		●			●	●		●		
5 Mbps							●	●		●			●	●		●		
3 Mbps							●	●		●			●	●		●		
1.5 Mbps																●		
0.8 Mbps																		
0.3 Mbps																		

\* ●: Distributable

■: Distributable when [Format] is configured as follows.

- QuickTime(H.264), Exchange (U model)
- MP4(H.264) (E model)

▲: When [Format] is configured to “QuickTime(MPEG2)” or “MXF(MPEG2)”, configuring [Time Stamp] to “On” or configuring [Overlay Function] to “Enable” disables distribution. **550**

Resolution	720 x 480 or 720 x 576			640 x 360								
Frame Rate	60i or 50i			60p, 50p			30p, 25p					
Type												
Bitrate	MPEG2-TS/UDP	MPEG2-TS/TCP	MPEG2-TS/RTP	RTSP	ZIXI	RTMP	MPEG2-TS/UDP	MPEG2-TS/TCP	MPEG2-TS/RTP	RTSP	ZIXI	RTMP
24 Mbps												
20 Mbps												
16 Mbps												
12 Mbps												
8 Mbps	●											
5 Mbps	●				●							
3 Mbps	●				●			●				
1.5 Mbps	●				●			●				
0.8 Mbps	●				●			●				
0.3 Mbps	●				●			●				

\* ●: Distributable

## Starting Distribution

### 1 Perform the necessary setting for the decoder and PC application.

For details on the settings, please refer to the "INSTRUCTIONS" of the respective devices and applications.

Memo : \_\_\_\_\_

- If there is an NAT router within the communication path between the camera and the decoder, port forwarding setup is required. For details on the settings, please refer to the "INSTRUCTIONS" of the router in use.
- The following parameters are required when connecting to this camera recorder using the RTSP/RTP.  
Port number: 554  
Stream ID: stream
- Use the following to access via URL.  
rtsp://<IP address of the camera recorder>:554/stream

### 2 With the network connection established, set [Live Streaming] to "On".



(☞ P178 [Preparing Network Connection] )

- Set [Network] → [Live Streaming] → [Live Streaming] to "On".
- The network connection mark appears on the display screen when a network connection is established.

(☞ P162 [Network Connection Icon] )

Memo : \_\_\_\_\_

- You can also assign "Live Streaming" to a user button.  
(☞ P46 [Assignment of Functions to User Buttons] )
- You can view the status of distribution on the LCD monitor.  
(☞ P164 [Live streaming mark] )

Icon	Status
 (Red)	Distribution in progress (good connection quality) Blinks when distribution starts or stops
 (Red)	Distribution in progress (poor connection quality)
 (Yellow)	Waiting for connection (during RTSP/RTP) or connection failed

- When the  icon is displayed, you can view the details of the error on the [Streaming] screen of the status screen.



(☞ P234 [List of Live Streaming Error Displays] )

Caution : \_\_\_\_\_

- Streaming may be interrupted temporarily 24 hours after the process started.



## Setting the FEC Matrix

Set the amount of FEC (Forward Error Correction) overhead for configuring SMPTE2022-1.

- 1 **Select [Network] → [Live Streaming] → [Streaming Server] → [Server1] to [Server4] → [FEC Matrix] and press the Set button.**

The FEC adjustment screen appears.



- 2 **Adjust the L and D values.**

Use the ◀▶ buttons to adjust the L value, and the ▲▼ buttons to adjust the D value.

The amount of FEC overhead changes when the L and D values are changed.

To restore the L and D values to their default values, press the [OIS/2] button.

Memo : \_\_\_\_\_

- Setting range
  - $4 \leq L \leq 20$  (Default value:  $L = 10$ )
  - $4 \leq D \leq 20$  (Default value:  $D = 10$ )
  - $L \times D \leq 100$  (Default value:  $L \times D = 10 \times 10$ )

- 3 **Press the Set button (●).**

The screen returns to the streaming server setting screen.



Memo : \_\_\_\_\_

- Increasing the amount of FEC overhead increases the packet loss resilience but more network bandwidth is used.
- Even with the same amount of overhead, increasing the L value will increase the packet loss (continuous packet loss) resilience.

# Return Video/Audio from the Network (Return over IP)

Return video/audio from the network can be displayed on the viewfinder or LCD monitor of the camera or listened through a headphone.

Memo : \_\_\_\_\_

- This feature is only usable in the Camera mode.
- Start the encoder before activating Return over IP. To end, turn off Return over IP before shutting down the encoder.
- This feature is available when [System] → [Record Set] → [Record Format] → [System] is set to “HD” or “SD”. When [A]Frame Rate is set to “24p”, this feature is not available.

## Configuring the Return over IP Server

Configure the Return over IP settings and establish the connection before displaying the return video.

### 1 Register the [Return Server].

Configure [Network] → [Return over IP] → [Server] to “Server”.

Configure the individual settings in the [Return Server] item.

Memo : \_\_\_\_\_

- For details on the registered information, please consult the network administrator for the server.
- Configure “Icecast” to a setting other than [Type].  
Operates as IFB when the setting is configured to “Icecast”.

## Return Video and Audio from the Network

### 1 Set the camera recorder to the Camera mode.

(☞ P24 [Operation Modes] )

### 2 Assign the “Return Video” and “Return over IP” features to any of the user buttons

(☞ P46 [Assignment of Functions to User Buttons] )

Memo : \_\_\_\_\_

- The “Return over IP” feature can also be operated using “On”/“Off” under [Network] → [Return over IP] → [Return over IP].

### 3 When [A]Format is configured to “QuickTime (MPEG2)” or “MXF(MPEG2)”, configure [Network] → [Return over IP] → [Function] to “Enable” <sup>550</sup>

(☞ P139 [ Function <sup>550</sup> ] )

### 4 Press the user button that is assigned with the “Return over IP” function.

### 5 Press the user button that is assigned with the “Return Video” function.

Displays the return video image.

The settings in [A/V Set] → [Audio Set] →

[IFB/RET Monitor] will be applied to the audio.

(☞ P134 [ IFB/RET Monitor... ] )

# IFB (Return Audio)

Return audio from the network can be played through a headphone.

Memo : \_\_\_\_\_

- This feature is only usable in the Camera mode.
- Start the encoder before activating Return over IP. To end, turn off Return over IP before shutting down the encoder.
- This feature is available when [System] → [Record Set] → [Record Format] → [System] is set to “HD” or “SD”. When [A]Frame Rate] is set to “24p”, this feature is not available.

## Configuring the Return over IP Server

Configure the Return over IP settings and establish the connection before displaying the return audio.

### 1 Register the [Return Server].

Configure [Network] → [Return over IP] → [Server] to “Server”.

Configure the individual settings in the [Return Server] item.

Memo : \_\_\_\_\_

- For details on the registered information, please consult the network administrator for the server.
- Configure “Iccast” to [Type].  
Operates as IFB when the setting is configured to “Iccast”.

## Return Audio from the Network (IFB)

### 1 Set the camera recorder to the Camera mode.

(☞ P24 [Operation Modes] )

### 2 Assign the “Return over IP” function to any of the user buttons.

(☞ P46 [Assignment of Functions to User Buttons] )

Memo : \_\_\_\_\_

- The “Return over IP” feature can also be operated using “On”/“Off” under [Network] → [Return over IP] → [Return over IP].

### 3 When [A]Format] is configured to “QuickTime (MPEG2)” or “MXF(MPEG2)”, configure [Network] → [Return over IP] → [Function] to “Enable”<sup>550</sup>

(☞ P139 [ Function **550** ] )

### 4 Press the user button that is assigned with the “Return over IP” function.

When Return over IP is activated, the settings in [A/V Set] → [Audio Set] → [IFB/RET Monitor] will be applied to the audio.

(☞ P134 [ IFB/RET Monitor... ] )

# Tagging Feature **SPC**

When using the Exchange file format, entering the tag information on the camera recorder helps to ease the management of tags during editing.

## Configuring to Exchange Format

To use the tagging feature, configure [System] → [Record Set] → [Record Format] → [A]Format to “Exchange”.

(☞ P56 [Selecting System Definition, File Format and Video Format])

## Configuring Camera Angle Information

Camera angle information can be recorded to the metadata of the recorded clip.

Configure the settings in [Camera Function] → [Camera Angle[Tagging]].

(☞ P113 [ Camera Angle[Tagging] **SPC** ] )

## Entering Tag Information

Tag information can be entered on the camera recorder or via the web function of the camera recorder.

### Entering Tag Information on the Camera Recorder

- 1 **Assign the tag to a user button**  
(☞ P116 [User Switch Set Item] )
- 2 **Press the user button that is assigned with the tag**
- 3 **Start recording.**
- 4 **To make changes, press the user button that is assigned with the tag.**
- 5 **Stop recording.**  
The tag is recorded to the .exchange file.

### Entering Tag Information via the Web Function

- 1 **Access the web function of this camera recorder via a web browser on devices such as a smartphone, tablet terminal or PC, and display the main page.**  
(☞ P178 [Preparing Network Connection] )  
(☞ P186 [Connecting from a Web Browser] )
- 2 **Press the “Sports Tagging” button to display the tag input screen.**
- 3 **Enter the tag information and press the “Enter” button**  
Enter “Title 1” and “Title 2” manually or using the template input button.
- 4 **Start recording.**
- 5 **To make changes, enter the tag information and press the “Enter” button**  
Enter “Title 1” and “Title 2” manually or using the template input button.
- 6 **Press the Set button**
- 7 **Stop recording.**  
The tag is recorded to the .exchange file.



- 1 **Sports Tagging Button**
- 2 **Current setting**  
Displays the text strings entered for [Title 1] and [Title 2] just before the Set button is last pressed.
- 3 **Data input boxes [Title 1] and [Title 2]**  
Text can be entered into the boxes directly. For smartphones or tablets, tapping the box displays a OS keyboard.
- 4 **Clear button**  
Clears the text in the [Title 1] and [Title 2] boxes.

- 5 Set button  
Sends the text strings in [Title 1] and [Title 2] to the camera recorder and the tag data of the clip is updated. Update of the tag data is possible while recording is in progress.
- 6 Template input button  
Enters a template phrase into the [Title 1].  
(Example) Pressing the [KO] button enters KO into "Title 1".
- 7 REMOVE Button  
Adds a REMOVE flag to the .xchange file of the clip that is currently being recorded. When recording is paused during Clip Continuous recording, pressing the REMOVE button adds a REMOVE flag to the .xchange file that was last recorded.
- 8 Stop Record Button  
Stops clip recording by the camera recorder. This button is active only during clip recording by the camera recorder.
- 9 Start Record Button  
Starts clip recording by the camera recorder. This button is active only when the camera recorder is ready to start recording.

Memo : \_\_\_\_\_

- You can enter up to 64 characters for "Title 1" and up to 128 characters for "Title 2".
- Changing (including clearing) the text in the "Title 1" and "Title 2" boxes does not automatically update the tag data of the recorded clip. Make sure to press the Set button to confirm the change. Changes in the tag data cannot be made to clips for which recording has already ended.
- Input of tag data in file formats other than MOV is not guaranteed.
- When a recorded clip is split into multiple files, the same tag information may not be saved to all the files depending on the timing at which the tag information is updated. It is recommended that a SDXC card be used with [System] → Record Set → [4GB File Spanning(SDXC)] configured to "Off".

## Synchronizing GPS Time Code

Time code information can be synchronized with the date/time information acquired from the GPS.  
(☞ P85 [Acquiring Positioning Information by GPS])

### Setting Time Code Generator

Set [TC/UB] → [TC Generator] to "Free Run(GPS)".  
(☞ P124 [ TC Generator ])

Memo : \_\_\_\_\_

- When [System] → [Record Set] → [Rec Mode] is configured to "Interval Rec" or "Frame Rec", "Free Run(GPS)" cannot be selected.
- The  icon lights up when the time code is synchronized.

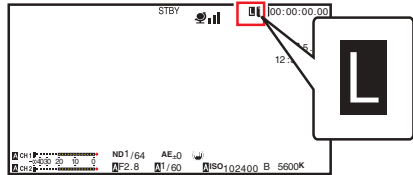

# Broadcast Overlay 550

## SPC

Texts, images and watermark can be overlaid onto recorded videos and live streaming videos from a smartphone or tablet device by importing the SDP file for broadcast.

Available when [System] is set to “HD” or “HD+Web”.

Use the SDP Generator to create the SDP file for broadcast.

- For information on SDP Generator, please contact your local dealer or download from our website.  
<http://www.jvc.net>

Caution :

- Regardless of the recording resolution (1920x1080, 1440x1080, 1280x720), the SDP file resolution that can be used on this camera recorder is fixed at 1920x1080.

Memo :

- Configuring Type to “Broadcast” in the factory settings displays a sample of the overlaid image.
- Check the display and operation in advance before recording or live streaming starts.

## Importing and Configuring Settings for SDP Files for Broadcast

Memo :

- When the recording format is “HD+Web”, the scoreboard display is always overlaid on the “Web” recording clip.
- The scoreboard display is always overlaid on live video streaming.
- The settings cannot be changed during recording or live streaming.

### 1 Set [Overlay Settings] → [Overlay Function] to “Enable”.

When [System] is configured to a setting other than “HD” and “HD+Web”, this item is fixed at “Disable”.

### 2 Use [Overlay Settings] → [Import User Layout] to import the file.

To use an overlay other than the SDP file at factory default, import the SDP file for broadcast to the camera.

### 3 Select the file for overlay from the imported file in [Overlay Settings] → [Layout].

### 4 Select “Broadcast” in [Overlay Settings] → [Type].

When the SDP file selected in [Layout] is created in a type other than “Broadcast”, or when the recording resolution of the “Broadcast” type of the SDP file is different from the recording resolution of the current camera, “Broadcast” is not displayed in [Type].

- Broadcast:  
Watermark



- None: No display

### 5 Select the display in [Overlay Settings] → [Output] → [HD Recording]/[HDMI]

(☞ P144 [ HD Recording ] )

(☞ P144 [ HDMI ] )

## Entering Overlay Text

### 1 Connect this camera recorder to the network

(☞ P179 [Connecting to the Network] )

### 2 Connecting from a web browser

(☞ P186 [Connecting from a Web Browser] )

### 3 When the web browser screen appears, press the overlay icon at the top of the screen or the [Overlay Control] button to display the input screen



### 4 One of the following screens appears according to the setting for [Type] in the camera recorder menu.



## Displaying Watermark Images

Import the SDP file in which the watermark image has been preconfigured to the camera recorder in advance.

The watermark setting menu will be displayed in the [Overlay Settings] menu screen only when the SDP file for broadcast is selected in [Overlay Settings] → [Layout].

- 1 Set [Overlay Settings] → [Watermark] to "On".
- 2 Select [Overlay Settings] → [Position].  
The watermark position setting screen appears.
  - The position is moved 2 steps at a time.
  - The displayed coordinates shows the position at the top left of the watermark image.
- 3 Use the cursor to move the watermark and press the Set (●) button

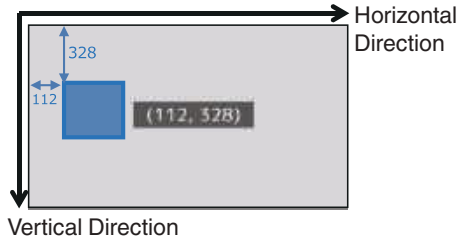

## Displaying Images on the Whole Screen (Full Screen Graphic Function)

Announcement and advertising images can be displayed across the whole screen.



### Importing Images for Display to the Camera

- 1 Prepare the image for display.  
JPEG (extension .jpg) and PNG (extension .png) formats are supported.
- 2 Copy the image file to the root directory of the SD card.
  - Use an SD card of a recordable specification in the current camera recording settings.
  - Up to 50 image files can be displayed.
  - The order of display by file name can be specified.

Memo : \_\_\_\_\_

- Add a two-digit number of 01 to 50 at the start of the file name. Files will be displayed in the order starting from those having the smallest number in the file name.  
Example: When 01flower.png, 02car.jpg, 13red.png are imported, they are displayed in the order of 01flower.png → 02car.jpg → 13red.png.
- Only alphanumeric characters and underscore ( \_ ) can be used for the third character onwards in the file name.
- Enter not more than 31 characters for the file name.

- 3 Select [Overlay Settings] → [Full Screen Graphic].
- 4 Insert the SD card where the image files are copied into the SD card slot A or B of the camera, and select [Import Graphic<sup>A</sup>] or [Import Graphic<sup>B</sup>] to import.
  - Once import is performed, all images previously imported will be deleted.
  - To delete the imported image files, select [Overlay Settings] → [Full Screen Graphic] → [Delete Graphic].



Memo : \_\_\_\_\_

- The total number of currently imported image files and the used capacity can be checked in [Overlay Settings] → [Full Screen Graphic] → [Status]. This capacity may be bigger than the actual image file size.
- The maximum import size is approx. 23 MB, after combining the capacity that can be checked in [Status] and the size of the imported SDP files.
- Images that can be displayed are as follows:
  - Image Size: 960x540
  - File Size: 1MB and below
  - JPEG:
    - Gradation: 8 bit
    - Pixel format: YCbCr or grayscale
    - Baseline JPEG
  - PNG:
    - Bit/Channel: 1, 2, 4, 8
    - Pixel format: Grayscale, Index, True color (RGB), grayscale with alpha, true color with alpha (RGBA)
    - Non-interlaced PNG
- When images that cannot be displayed are imported to the camera, an error message "Unsupported Graphic Format" is displayed on the camera recorder while image display is in progress. Check in advance that images can be displayed as per expectation.

## Displaying Images

Display the image from the web screen for setting the overlay.

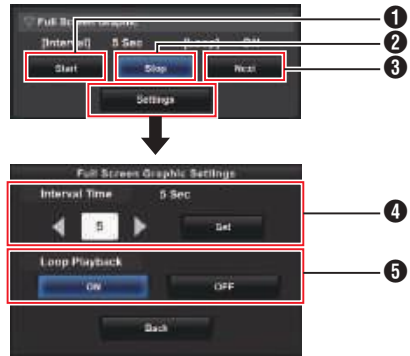

- 1 Start:  
Starts the display of images.
- 2 Stop:  
Stops the display of images.
- 3 Next:  
Image in : Displays the next image.  
display  
Image : Starts displaying from the next  
not in image of the image at which the  
display display stopped previously.  
Depending on the status of the camera, it may  
take a while to display the next image after  
pressing the [Next] button.
- 4 Interval Time:  
Sets the display time per image.  
Depending on the status of the camera, it may  
take a while to display the next image after  
pressing the [Start] button. A time longer than  
the configured interval time may be  
displayed.
- 5 Loop Playback:  
Select [ON] to return to the first image after the  
last image is displayed.

Memo : \_\_\_\_\_

- To display only one image continuously, set [Interval Time] to “0”.
- When recording is performed together with live streaming or when there is a lot of information display on the LCD/VF screen, images may take more than 10 seconds to display. It is possible to reduce the time taken to display by lowering the resolution of the recording and live streaming or by pressing the [DISPLAY] button of the camera recorder to turn off the display screen.
- To use only the Full Screen Graphic function without the overlay display, select [Overlay Settings] → [Type] and choose options other than “None”. Then, set the [Overlay] button on the web screen for controlling the overlay to Off.
- When the format of the next image to be displayed is not supported during image display, “Unsupported Graphic Format” will be displayed on the camera recorder, and that image will not be displayed. Import images that support a displayable format.  
( P216 [Importing Images for Display to the Camera] )

## Protecting Overlay Settings with a Password

You can use a password to protect overlay settings to prevent the cancellation of watermark display by a third party.

### Protecting with a Password

- 1 Set [Overlay Settings] → [Password Lock] to “On”.**
- 2 Enter the protection password and press the cross-shaped button (▶).**  
Enter not more than 16 characters for the password using the software keyboard.
- 3 Enter the same password again and press the cross-shaped button (▶).**
- 4 Press [Set].**  
A password request screen will appear subsequently before you enter the [Overlay Settings] screen.

Caution : \_\_\_\_\_

- Do not forget the password that you have set. If the password is lost or forgotten, you cannot deactivate the password protection function.

Memo : \_\_\_\_\_

- When overlay settings are protected by a password, the following items in [System] are grayed out and cannot be selected.
  - [Reset All]
  - [Record Set] → [Record Format]
  - [Setup File] → [Load File] → [Picture File]/[User File]/[All File]
  - [Setup File] → [Store File] → [Picture File]/[User File]/[All File]

### Deactivating Password Protection

- 1 Select [Overlay Settings].**  
A password request screen appears.
- 2 Enter the password and press the cross-shaped button (▶).**  
If the password matches the configured password, the [Overlay Settings] menu appears.
- 3 Change [Password Lock] to “Off”.**
- 4 Press [Set] to close the deactivation complete screen.**

### 1 Connect the camera recorder to a network compatible device such as a mobile device via the network.

(☞ P178 [Preparing Network Connection])

When network connection is established between the devices, start the Web browser on the network compatible device.

### 2 Enter the following URL in the address bar of the Web browser.

http:// "IP address of camera recorder"

Example; http://192.168.0.1

You can check the "IP address of camera recorder" by pressing the [STATUS] button on the camera recorder to display the Status screen and use the cross-shaped button (◀▶) to display the Network screen.

### 3 Enter the user name and password.

Enter the user name and the password on the login screen to display the main page of the camera.

### 4 Press the overlay control icon at the top of the screen or the [Overlay Control] button to display the Settings screen



### 5 Press the [Update] button to reflect the specified text and images in the overlay.

## Scoreboard Overlay SPC

By using a smartphone or tablet, a scoreboard can be overlaid onto a recorded or live streaming video. Available when [System] is set to "HD" or "HD+Web".

Memo : \_\_\_\_\_

- Check the display and operation in advance before recording or live streaming starts.

### Configuring Scoreboard Display

Caution : \_\_\_\_\_

- Regardless of the recording resolution (1920x1080, 1440x1080, 1280x720), the SDP file resolution that can be used on this camera recorder is fixed at 1920x1080.

Memo : \_\_\_\_\_

- When displaying soccer or ice hockey, import an SDP file to the camera recorder in advance. Create an SDP file using the SDP Generator. Next, select the imported SDP file in [Overlay Settings] → [Layout].
- When the recording format is "HD+Web", the scoreboard display is always overlaid on the "Web" recording clip.
- The scoreboard display is always overlaid on live video streaming.

### 1 Configure [Overlay Settings] → [Overlay Function] to "Enable".

When [System] is configured to a setting other than "HD" and "HD+Web", this item is fixed at "Disable".

### 2 Import the file in [Overlay Settings] → [Import User Layout]

- Create SDP files for scoreboard overlay in advance using the SDP Generator.
- Skip step 2 if [Layout] is to be configured to "Default" in step 3.

### 3 Select [Overlay Settings] → [Layout].

### 4 Select [Overlay Settings] → [Type].

### 5 Select the display in [Overlay Settings] → [Output] → [HD Recording]/[HDMI]

(☞ P144 [ HD Recording ])

(☞ P144 [ HDMI ])

## Configuring Scoreboard Display Position

The scoreboard can be displayed at the following positions on the screen. Create an SDP file with the desired display position in the SDP Generator and import the file to the camera recorder.

(P228 [Importing an image containing the team name and logo])

Type	Overlay Location	
Type 1	Top, Bottom	
Type 2	Top, Bottom	
Football	Top, Bottom	
Basketball	Top, Bottom	
Baseball	Top Right, Bottom Right, Top Left, Bottom Left	
Soccer	Small	Top Right, Bottom Right, Top Left, Bottom Left
	Large	Bottom (not changeable)
	Penalty Shoot-out	Bottom (not changeable)
Hockey	Top Right, Bottom Right, Top Left, Bottom Left	

### Type 1 :



### Type 2 :

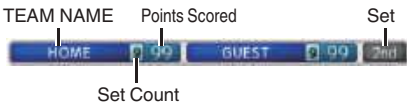

### Football :

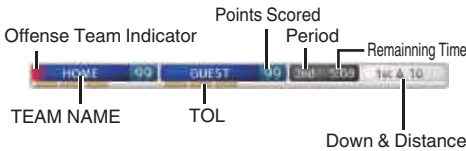

### Basketball :

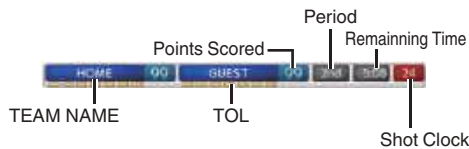

### Baseball :

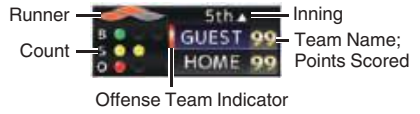

### Soccer :

Select [Small], [Large] or [Penalty Shoot-out] in the Overlay Control web screen.

#### [Small]

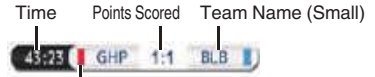

Team Logo (Small)



Additional Time



Minutes of Added Time

#### [Large]

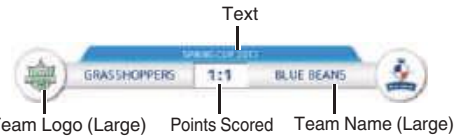

#### [Penalty Shoot-out]



## Hockey :

Select [Small] or [SHOOTOUT] in the Overlay Control web screen.  
[Small]



## [SHOOTOUT]

Rounds 1 to 3



Rounds 4 and later



**None: Does not display**

## Entering Scoreboard Data

- 1 **Connect this camera recorder to the network**  
(☞ P179 [Connecting to the Network] )
- 2 **Connecting from a web browser**  
(☞ P186 [Connecting from a Web Browser] )
- 3 **When the web browser screen appears, press the overlay icon at the top of the screen or the [Overlay Control] button to display the input screen**



- 4 **One of the following screens appears according to the setting for [Type] in the camera recorder menu.**

All information except for the numerical values is reflected immediately on the scoreboard display without the need to press the [Update] button.

Memo : \_\_\_\_\_

- When the camera recorder is live streaming while recording, the update interval of the time display may not be constant. When this happens, reduce the resolution of the live streaming.
- \_\_\_\_\_

## Type 1

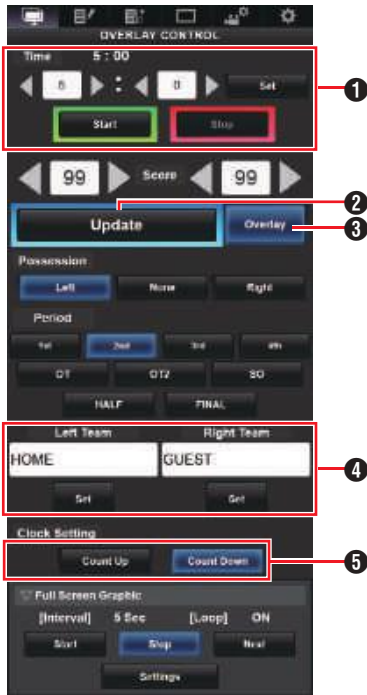

- ❶ Time  
The start time entered is reflected on the score overlay by pressing the [Set] button.
- ❷ [Update] Button  
Reflects numerical values such as score and distance on the score overlay.
- ❸ [Overlay] Button  
Turns the score overlay on or off.
- ❹ Team Name (for text input)  
If the SDP file selected in the menu item [Overlay Settings] → [Layout] contains more than one team name image, this item is grayed out and text input is disabled.
- ❺ Clock Count Direction  
Count Up: Increase  
Count Down: Decrease

## Type 2



- ❶ [Update] Button  
Reflects numerical values such as score and distance on the score overlay.
- ❷ [Overlay] Button  
Turns the score overlay on or off.
- ❸ Team Name (for text input)  
If the SDP file selected in the menu item [Overlay Settings] → [Layout] contains more than one team name image, this item is grayed out and text input is disabled.

## Football

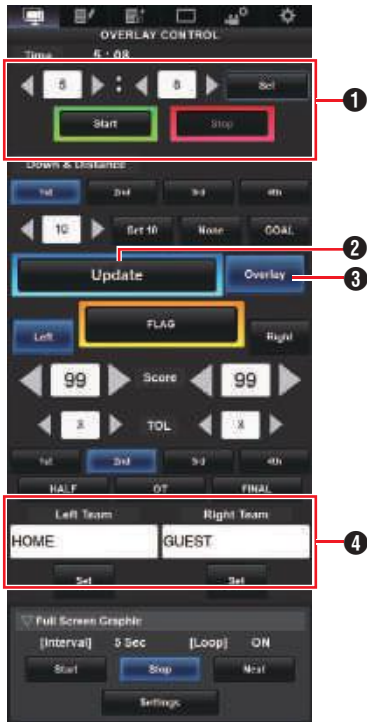

- 1 Time  
The start time entered is reflected on the score overlay by pressing the [Set] button.
- 2 [Update] Button  
Reflects numerical values such as score and distance on the score overlay.
- 3 [Overlay] Button  
Turns the score overlay on or off.
- 4 Team Name (for text input)  
If the SDP file selected in the menu item [Overlay Settings] → [Layout] contains more than one team name image, this item is grayed out and text input is disabled.

## Baseball

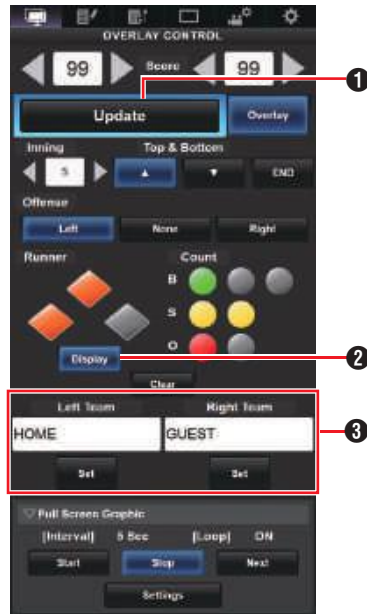

- 1 [Update] Button  
Reflects numerical values such as score and distance on the score overlay.
- 2 [Display] Button  
Displays or hides specific areas.
- 3 Team Name (for text input)  
If the SDP file selected in the menu item [Overlay Settings] → [Layout] contains more than one team name image, this item is grayed out and text input is disabled.

## Basketball

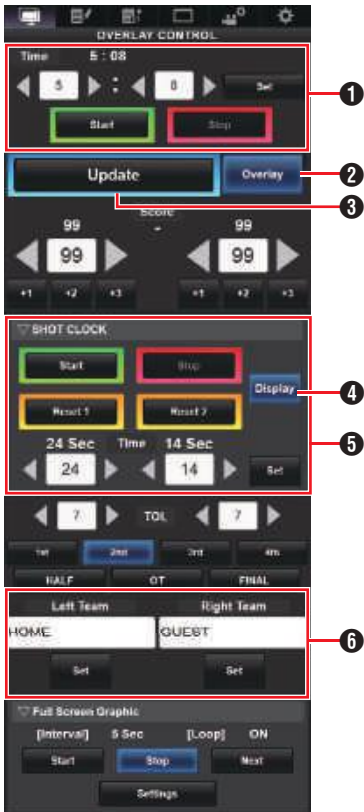

- 1 Time**  
The start time entered is reflected on the score overlay by pressing the [Set] button.
- 2 [Update] Button**  
Reflects numerical values such as score and distance on the score overlay.
- 3 [Overlay] Button**  
Turns the score overlay on or off.
- 4 [Display] Button**  
Displays or hides specific areas.
- 5 [Reset1]/[Reset2] Button for Shot Clock**  
Resets the value (in seconds) set below [Set] Button  
Confirms the value (in seconds) when [Reset1]/[Reset 2] button is pressed
- 6 Team Name (for text input)**  
If the SDP file selected in the menu item [Overlay Settings] → [Layout] contains more than one team name image, this item is grayed out and text input is disabled.



# Soccer

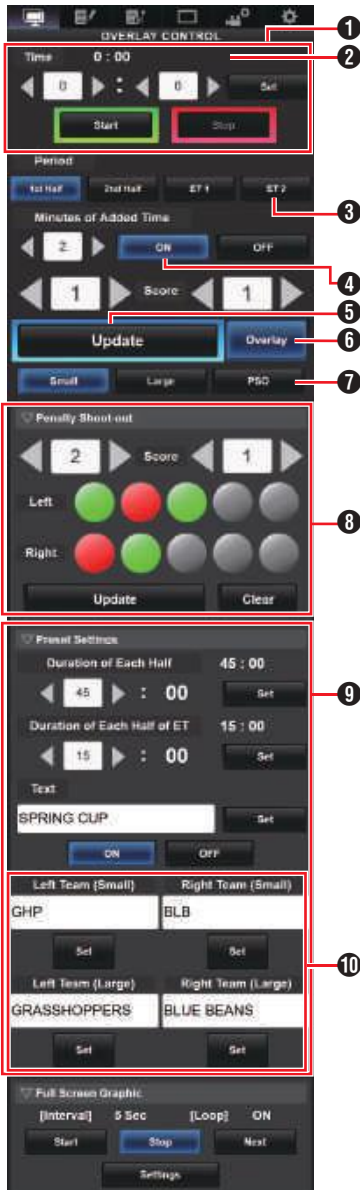

- 1 Time**  
The start time entered is reflected on the score overlay by pressing the [Set] button.
- 2 Time (Left):**  
Currently displayed match time.  
**Time (Right):**  
Currently displayed additional time. Displayed only during additional time.
- 3 Period:**  
Can be changed only when the clock is stopped.
- 4 Minutes of Added Time:**  
Displays the additional time granted only during additional time if "ON" is selected.
- 5 [Update] Button**  
Reflects numerical values such as score and distance on the score overlay.
- 6 [Overlay] Button**  
Turns the score overlay on or off.
- 7 Display Type:**  
[Small] Button: Small display  
[Large] Button: Large display  
[PSO] Button: Penalty Shoot-out displayMinutes
- 8 Penalty Shoot-out:**  
Use when "PSO" is selected.
- 9 Preset Settings:**  
Items to be set before the match. Set the duration of each halftime, texts to be displayed in the Large display, and team names to be used in the Small and Large displays.
- 10 Team Name (for text input)**  
If the SDP file selected in the menu item [Overlay Settings] → [Layout] contains more than one team name image, this item is grayed out and text input is disabled.

# Hockey

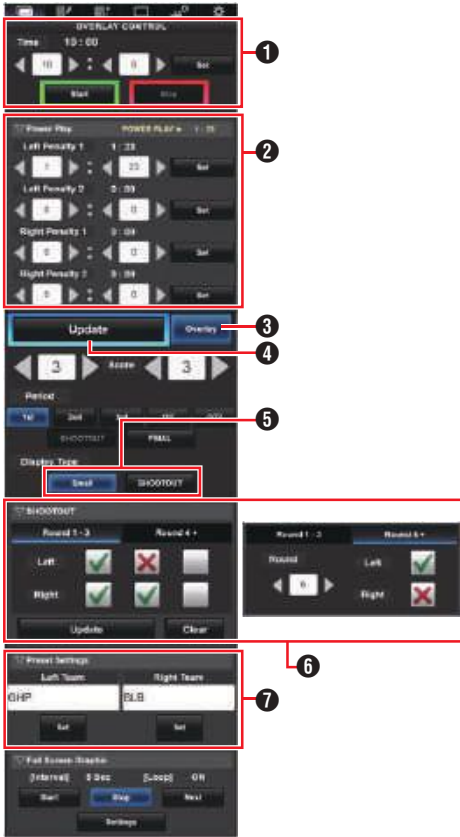

- 1 Time  
The start time entered is reflected on the score overlay by pressing the [Set] button.
- 2 Power Play:  
Entering the penalty time displays the power play state that corresponds to it.
- 3 [Overlay] Button  
Turns the score overlay on or off.
- 4 [Update] Button  
Reflects numerical values such as score and distance on the score overlay.
- 5 Display Type:  
[Small] Button: Small display  
[SHOOTOUT] Button: Shoot-out display
- 6 SHOOTOUT:  
[Round 1-3] Tab: For round 1 to 3  
[Round 4+] Tab: For round 4 and later
- 7 Team Name (for text input)  
If the SDP file selected in the menu item [Overlay Settings] → [Layout] contains more than one team name image, this item is grayed out and text input is disabled.

## Additional time display for Soccer

The display of additional time toggles on and off automatically depending on the elapsed time of [Time] and the status of [Period]. Whether a match is in additional time is determined by the setting values of [Duration of Each Half] and [Duration of Each Half of ET] of [Preset Settings]. The display example is as follows.

Example) Duration of Each Half: "45:00", Duration of Each half of ET: "15:00"

Period	Time	Time Display
1st Half	1:23	
	46:23	
2nd Half	46:23	
	91:23	
ET 1	91:23	
	106:23	
ET 2	106:23	
	121:23	

## Power play for Hockey

Depending on the state of the penalty time, power play is automatically displayed or hidden. The display example is as follows.

Penalty Time				Time Display	
Left Team		Right Team		Display Position	Display Time
Penalty 1	Penalty 2	Penalty 1	Penalty 2		
0:00	0:00	0:00	0:00		—
0:00	0:00	Time C	0:00		Time C
0:00	0:00	Time C	Time D		Time C or D (the smaller of the two)
Time A	0:00	0:00	0:00		Time A
Time A	0:00	Time C	0:00		Time A or C (the smaller of the two)
Time A	0:00	Time C	Time D		Time A, C or D (the smallest of the three)
Time A	Time B	0:00	0:00		Time A or B (the smaller of the two)
Time A	Time B	Time C	0:00		Time A, B or C (the smallest of the three)
Time A	Time B	Time C	Time D		Time A, B, C or D (the smallest of the four)

## Team Display Settings

Team names can be displayed by one of the following ways.

- Specifying texts directly from web browser
- Importing an image containing the team name and logo

### Specifying texts directly from web browser

Enter the texts in the Overlay Control web screen. Available characters are as follows. However, text cannot be entered when using a SDP file containing team name images.

```
!"#$%&'()*+,-./0123456789:;<=>?@ABCDEFGHIH  
IJKLMNOPQRSTUVWXYZ[\]^_`abcdefghijklmnopklmno  
pqrstuvwxyz{|}~¡¢£¥¦§¨ª«¬®¯°±²³´µ¶·¸¹º»¼½  
¾¿ÀÁÂÃÄÅÆÇÈÉÊËÌÍÎÏÐÑÒÓÔÕÖ×ØÙÚÛÜÝ  
Þßàáâãäåæçèéêëìíîïðñóôõö÷øùúûüýþÿĜğĦıĬĲ  
œššŸŹžƒ~—“”„†‡…%<>€™
```

Memo : \_\_\_\_\_

- For some types of text, the text that has been entered may not be displayed fully on the overlaid display. Check the display in advance.

### Importing an image containing the team name and logo

To display a team name with logo or a team name that contains characters that are not available for input, an image can be imported to the camera recorder in place of text input for display at the team name area of the score overlay.

The data file (SDP file) to be imported can be generated by an SDP Generator, a PC/Mac application. A maximum of 30 teams can be registered.

For information on SDP Generator, please contact your local dealer or download from our website.  
<http://www.jvc.net>

Caution : \_\_\_\_\_

- Please check the content and font licenses of the image before use.

### 1 Copy the SDP file to the root folder of an SD card

Copy the SDP file generated by the SDP Generator to the root folder of an SD card. Specify a name for the SDP file that is not longer than 63 alphanumeric characters with a “sdp” extension.

Example: [overlay1.sdp]

### 2 Insert the SD card in which the SDP file is copied into slot A or B,

then select [Overlay Settings] → [Import User Layout].

The SDP files in the root folder of the SD card are displayed (max. 8 files per slot). However, if the file name is long and cannot be displayed on the menu screen, the file will be displayed with part of the file name omitted.

Select an SDP file to import from the list of displayed SDP files.

### 3 Import the file

Select an import destination from areas 1 to 4 to start importing. If you select an area where a file name is already displayed, a confirmation screen asking whether to overwrite will appear. It will take about 20 to 30 seconds to complete the import. “Complete” will be displayed at the end. A gray display area indicates insufficient space and it cannot be selected. Select another area or delete SDP files that are not required in advance in [Overlay Settings] → [Delete User Layout].

Caution : \_\_\_\_\_

- Do not turn off the power of the unit during import. You may lose the import data.

- When import is successful, the name of the imported SDP file will be added to the [Overlay Settings] → [Layout] item. Select an SDP file name suitable for overlay. If a valid SDP file is not imported to the camera recorder, or if the SDP file imported does not match the recording format of the camera recorder, the [Type] item will be displayed as “None” and grayed out. Import a correct SDP file with [Import User Layout].

- Select the team name to display in [Main Menu] → [Overlay Settings] → [Left Team] (\*) or [Right Team] (\*).

\* This menu item name can be changed in the SDP Generator settings.

- It is recommended that you check the display of imported team names or logos before recording starts.

## Deleting an Imported SDP File

You can delete an imported SDP file.

- 1 Select [Overlay Settings] → [Delete User Layout].
- 2 Select an SDP file to delete.  
The blue line at the background of the SDP file name indicates that the file is applied for the current overlay.



Memo :

- The imported SDP file cannot be deleted in [System] → [Reset All]. Please use this function to delete.

## Entering Scoreboard Data Automatically

By using a scoreboard solution supplied from Sportzcast, the camera can ingest scoreboard data automatically. This enables the updating of the scoreboard display without having to manually enter the scores from the Web screen. Please contact the local dealers in your area on the Sportzcast solution.

### Configuring the Server

To connect to the Sportzcast cloud service, select “Cloud” in the [Sever Settings] (P 146).

Meanwhile, connection to a Sportzcast that is connected to a local network can be configured using [Search Local Server]. Start search after powering on Scorebot and connecting it to the same network as the camera recorder.

- 1 From the list of search results, select the Scorebot to connect and press the cross-shaped button (▶).



- 2 Details of the selected Scorebot will be displayed. Check the information and press the cross-shaped button (▶).
- 3 Once the connection is successfully established, a confirmation screen appears. Press the cross-shaped button (▶).
- 4 Select [Sever Settings] of the destination for saving and press the cross-shaped button (▶).

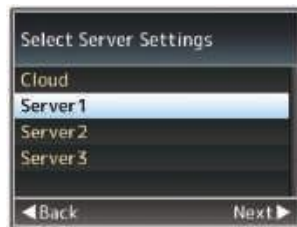

- 5 Enter the [Alias] name to save and press the cross-shaped button (▶).
- 6 After the connection complete screen appears, press the Set button (●) to close the menu screen.

Memo : \_\_\_\_\_

- If a Scorebot is currently being connected, search cannot be performed until the connection has been terminated.
- Old settings that are saved in [Sever Settings] at the storage destination will be overwritten.
- Connection is automatically established upon exiting the Wizard, and the [Server] setting switches to [Sever Settings] while the camera is connected to the Scorebot.

The connection status to the Sportzcast server is displayed in the "Sportzcast" item of the status screen (Network) as follows.

- Press the [STATUS] button on the camera recorder to display the status screen. Press the cross-shaped button (◀▶) to display the [Network] screen.
- Check the displayed [Sportzcast].

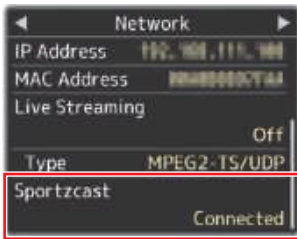

### Changing Sportzcast Settings

The different settings can be configured in the respective items under [Overlay Settings] → [Sportzcast] → [Settings].  
 (☞ P145 [ Sportzcast **SPC** ])

# Error Messages and Actions

Warning display on the LCD monitor and viewfinder screen, tally lamp indication and warning tone are as follows according to the error status.

Memo : \_\_\_\_\_

- This camera recorder makes use of a microcomputer. Noise interference from external sources may prevent it from functioning properly. When this occurs, turn off and on the power of the camera recorder again.

Error Message	Status	Action
Turn Power Off Turn Back On Later	System error. * The warning tone sounds and the tally lamp blinks twice every second.	Turn off the power, and turn it on again. If the error persists, please contact the local dealers in your area.
Fan Stop Detected Please Turn P.Off	• The fan stopped running.	Please contact the local dealers in your area.
Fan Maintenance Required	Usage time of the fan has exceeded 9000 hours.	Check the fan and replace accordingly. For more details, please contact the local dealers in your area.  Memo : _____ • You can check the usage time of the fan in [System] ➔ [System Information] ➔ [Fan Hour]. (☞ P149 [ Fan Hour ] )
Getting Overheated. Please Turn Power Off.	• The battery has exceeded the specified temperature. • The power turns off automatically after about 15 second.	• Wait until the temperature drops or replace the battery. • If the error persists, please contact the local dealers in your area.
Rec Inhibited	[REC] button is pressed when the write-protect switch of the SD card is set.	Turn off the write-protect switch of the SD card, or insert a recordable SD card. (☞ P48 [Recording Media] )
Lost Media Info *	• Card is removed while recording is in progress. • Card is removed while formatting is in progress. • Card is removed while restoring is in progress. • Card is removed while adding the OK mark. • Card is removed while writing a setup file. • Card is removed while deleting a clip. (*: A, B)	Restore the card using this camera recorder. (☞ P52 [Repairing the Recording Media] )

Error Message	Status	Action
Record Format Incorrect	<ul style="list-style-type: none"> <li>The video format of the file for Clip Review is different from the current [A]Resolution, [A]Frame Rate, or [A]Bit Rate setting.</li> </ul>	Set [A]Resolution, [A]Frame Rate and [A]Bit Rate correctly. (☞ P150 [A]Resolution/ [EXT]Resolution ) (☞ P151 [A]Frame Rate/ [EXT]Frame Rate ) (☞ P151 [A]Bit Rate/ [EXT]Bit Rate )
Media Full	<ul style="list-style-type: none"> <li>[REC] button is pressed when the media in use has no remaining space.</li> <li>Remaining space ran out during recording.</li> </ul>	Replace the recording media with a new one.
No Clips	No viewable clips are found on the card for Clip Review.	Insert an SD card that contains clips that can be reviewed. (☞ P48 [Recording Media] ) (☞ P86 [Viewing Recorded Videos Immediately (Clip Review)] )
No Media	When the [REC] button is pressed while a recording media is not inserted.	Insert a recording media. (☞ P48 [Recording Media] )
No Media	No recording media is inserted while in Media mode or when the thumbnail screen is displayed.	Insert a recording media. (☞ P48 [Recording Media] )
No Clips	No clips are found in the inserted recording media while in Media mode or when the thumbnail screen is displayed.	Insert a recording media that contains playable clips. (☞ P48 [Recording Media] ) (☞ P97 [Playing Recorded Clips] )
Recording has stopped as it has exceeded 4 hours	When continuous recording in "4K EXT (SSD)" has exceeded 4 hours.	Start recording again.

## List of FTP Transfer Errors

If the upload of a recorded clip or download of the metadata setup file (XML format) is not successfully completed, the following errors are displayed.

Error message	Status	Action
Timeout.	Transfer was discontinued due to timeout caused by network transmission or server failure.	<ul style="list-style-type: none"> <li>Execute again.</li> <li>Use a different server.</li> </ul>
Media Was Removed.	Recording media is removed while FTP transfer is in progress.	Insert the recording media and execute FTP transfer again.
Adapter Was Removed.	The USB network device is removed while FTP transfer is in progress.	Connect the USB network device.
Cannot Connect to Server.	Unable to connect to the FTP server.	Adjust the Server and Port settings for [Metadata Server] or [Clip Server]. (☞ P135 [ Metadata Server... ] ) (☞ P143 [ Clip Server ] )



Error message	Status	Action
Access Denied.	Access is denied.	Adjust the Server and Port settings for [Metadata Server] or [Clip Server]. (☞ P135 [ Metadata Server... ] ) (☞ P143 [ Clip Server ] )
Invalid Username or Password.	Authentication for login to the FTP server failed.	Adjust the Username and Password settings for [Metadata Server] or [Clip Server]. (☞ P135 [ Metadata Server... ] ) (☞ P143 [ Clip Server ] )
Invalid Path Was Requested.	The path specified for the FTP server is incorrect.	Adjust the [Clip Server] and [Dir. Path] settings for [Metadata Server] or [File Path]. (☞ P135 [ Metadata Server... ] ) (☞ P143 [ Clip Server ] )
Server Error.	There was an unintended operation of the FTP server.	Execute again. Use a different server.
Invalid Request.	A bad request is executed for the FTP server.	Execute again.
Invalid Data Size.	Invalid data size, such as a planning metadata size that exceeds 4 KB.	Adjust the planning metadata saved in the [Metadata Server]. (☞ P187 [ Planning Metadata ] )
Invalid Data Format.	The XML format of the planning metadata is invalid.	Adjust the planning metadata saved in the [Metadata Server]. (☞ P187 [ Planning Metadata ] )
Transfer Error.	Transfer failed due to communication failure.	Execute again.
Invalid URL.	The path was deemed invalid by the FTP server.	Adjust the Server and Port settings for [Metadata Server] or [Clip Server]. (☞ P135 [ Metadata Server... ] ) (☞ P143 [ Clip Server ] )
Media Access Error.	Reading/writing of the recording media failed while FTP transfer is in progress.	Use a different recording media.
Internal Error.	An internal error has occurred while FTP transfer is in progress.	Adjust the settings and execute again.
Other Error.	An unknown error or other errors have occurred while FTP transfer is in progress.	Adjust the settings and execute again.
Media Read Error.	Reading of the recording media failed while FTP transfer is in progress.	Use a different recording media.

## List of Live Streaming Error Displays

The following error messages are displayed when the live streaming setting is incorrect, or when the connection is lost during live streaming.

Error message	Status	Action
Invalid Address	<ul style="list-style-type: none"> <li>The IP address format is incorrect.</li> <li>The domain name cannot be converted into the IP address.</li> </ul>	<ul style="list-style-type: none"> <li>Enter the IP address, host name or URL of the destination correctly. (☞ P206 [Setting Distribution] )</li> </ul>
Multicast Is Not Supported	An IP multicast address was set.	Use an IP address that is not a multicast address.
Cannot Connect to Receiver	Establishment of connection with TCP failed.	<ul style="list-style-type: none"> <li>Ensure that the recipient's device is set to TCP.</li> <li>Set Type to "MPEG2-TS/UDP". (☞ P206 [Setting Distribution] )</li> </ul>
TCP Disconnected	TCP connection is lost.	Check to ensure that there is no abnormality in the decoder, or network connection device and cables, followed by establishing the connection again.
Not Enough Bandwidth	<ul style="list-style-type: none"> <li>The communication bandwidth is narrower than the average bit rate.</li> <li>The network bandwidth is insufficient, and packets are discarded.</li> </ul>	<ul style="list-style-type: none"> <li>Lower the resolution/picture quality of the video to be distributed.</li> <li>Consider switching to the use of a stable network, such as wired LAN.</li> </ul>
Connection Timeout	Timeout for connection via ZIXI.	Set [Destination Address] and [Destination Port] correctly. (☞ P206 [Setting Distribution] )
Authorization Failed	Authentication of connection via ZIXI failed.	Set [Stream ID] and [Password] correctly. (☞ P206 [Setting Distribution] )
Connection Error	Connection via "ZIXI" or "RTMP" failed.	<ul style="list-style-type: none"> <li>Check whether a different camera with an identical stream ID is connected.</li> <li>Set [Destination URL] and [Stream Key] correctly. (☞ P138 [ Destination URL ] ) (☞ P138 [ Stream Key ] )</li> </ul>
Disconnected	"ZIXI" or "RTMP" connection is lost.	Check whether there is abnormality with the network connection device, cables, etc., and try to re-establish the connection.

## List of Layout Import Error Displays 550 SPC

Error Message	Status	Action
Failed To Read File From Media!	SD card is defective.	Use other SD card.
	SDP file data is corrupted.	Use the SDP file generated by the SDP Generator.
No User Layout Exists.	SDP file data is corrupted.	Use the SDP file generated by the SDP Generator.
	The camera recorder version is old and an unknown SDP file has been imported.	Update the firmware for the camera recorder to the latest version.
Failed To Write File To The Camera!	There may be a problem with the camera.	Please contact the local dealers in your area.
Import Error!	An internal error has occurred.	Please contact the local dealers in your area.

## List of Sportzcast Connection Error Displays SPC

Error Message	Status	Action
Cannot Connect to Server	Cannot connect to the Sportzcast server.	Check that the network connection settings are correct.
		Enter the IP address or host name of the Sportzcast server correctly.
Invalid License	Sportzcast license is invalid.	Enter the license name correctly. Please note that you cannot use a license name you have already used in another camera.
Cannot Get Node	Server response is invalid.	Please contact Sportzcast.
Invalid BOT Number	The BOT number entered is invalid.	Enter the Sportzcast BOT number correctly.

## Blinking of the Tally Lamp

The tally lamp starts blinking when the remaining space on the recording media is running out during recording or when the battery power is running low.

Blinking Mode	Remaining Battery Power/SD Card Space
Blinks slowly (once every second)	<ul style="list-style-type: none"><li>• Battery power is low</li><li>• Remaining recording time on recording media is less than 3 minutes (during recording)</li><li>• When a malfunction occurred during live streaming</li></ul>
Blinks quickly (2 times per second)	<ul style="list-style-type: none"><li>• Remaining battery power is almost zero</li><li>• Remaining recording time on recording media has reached 0 minutes (during recording)</li><li>• Error on the camera recorder</li></ul>

## Warning Tone

- Warning tone is output from the speaker and [⏸] terminal when the battery level is low. Warning tone is also output when an error occurs in the camera recorder.

Memo : \_\_\_\_\_

- You can specify whether to turn on the warning tone as well as setting the volume in [A/V Set] → [Audio Set] → [Alarm Level].  
(☞ P134 [ Alarm Level ] )

# Troubleshooting

Symptom	Action
Power does not turn on.	<ul style="list-style-type: none"> <li>• Is the AC adapter properly connected?</li> <li>• Is the battery charged?</li> <li>• Is the power turned on immediately after it is turned off? Make sure to wait for an interval of at least 5 seconds before turning on the power again.</li> </ul>
Unable to start recording.	<ul style="list-style-type: none"> <li>• Is the record trigger button/lock switch on the handle turned on?</li> <li>• Is the write-protect switch of the SD card turned on? Make sure that the write-protect switch is turned off. (☞ P49 [Write-Protect Switch on the SD Card] )</li> <li>• Is the camera recorder set to the Camera mode? Use the [MODE] selection button to switch to the Camera mode. (☞ P24 [Operation Modes] )</li> <li>• Is the SD card inserted compatible with the recording format? (☞ P57 [Selecting a Video Format] ) (☞ P154 [ 4GB File Spanning(SDXC) ] )</li> </ul>
Camera image is not output on the LCD monitor and viewfinder screen.	<ul style="list-style-type: none"> <li>• Is the camera recorder set to the Camera mode? Use the [MODE] selection button to switch to the Camera mode. (☞ P24 [Operation Modes] )</li> <li>• The LCD monitor and viewfinder screens cannot be displayed at the same time. To display the viewfinder screen, close the LCD monitor or press and hold the [DISPLAY] button.</li> </ul>
Playback does not start after selecting a clip thumbnail and pressing the Set button (●).	<ul style="list-style-type: none"> <li>• Is the selected clip a playable clip? Playback is not possible if the clip has a different video format setting.</li> </ul>
Images on the LCD monitor and viewfinder screen appear dark or blurred.	<ul style="list-style-type: none"> <li>• Readjust the brightness of the LCD monitor and viewfinder.</li> <li>• Is the [ND FILTER] switch set to "1/64"?</li> <li>• Is the iris closed?</li> <li>• Is the shutter speed setting too high?</li> <li>• Is the peaking level too low? Use the [PEAKING +/-] button to adjust the contour for the LCD monitor and the viewfinder screen. (☞ P43 [Adjusting the LCD Monitor] ) (☞ P44 [Adjusting the Viewfinder] )</li> </ul>
The [CH1/CH2] recording level adjustment knob does not work.	<ul style="list-style-type: none"> <li>• Is the [CH1/CH2 AUTO/MANUAL] switch set to "AUTO"?</li> <li>• Is the [FULL AUTO] switch set to "ON"? Is the [FULL AUTO] switch set to "ON", and [A/V Set] → [Audio Set] → [FULL AUTO] set to "Auto"? (☞ P134 [ Audio On FULL AUTO ] )</li> </ul>
Microphone audio cannot be heard through the headphone.	<ul style="list-style-type: none"> <li>• Is the audio setting configured to "IFB/RET Only"? Set [A/V Set] → [Audio Set] → [IFB/RET Monitor] → [CH1]/[CH2] to "Off". (☞ P134 [ IFB/RET Monitor... ] )</li> </ul>
SD card cannot be initialized (formatted).	<ul style="list-style-type: none"> <li>• Is the write-protect switch of the SD card turned on? Make sure that the write-protect switch is turned off. (☞ P49 [Write-Protect Switch on the SD Card] )</li> </ul>
Battery alarm appears even after loading a charged battery.	<ul style="list-style-type: none"> <li>• Is the battery too old?</li> </ul>

Symptom	Action
The time code and user's bit are not displayed.	<ul style="list-style-type: none"> <li>• Even in Camera mode or Media mode, the time code and user's bit may not be displayed depending to the type of display.</li> <li>• Is [LCD/VF] → [Display On/Off] → [TC/UB] set to "Off"? To display the date and time, set it to "On". (☞ P129 [Display On/Off Item] )</li> </ul>
The time is not displayed.	<ul style="list-style-type: none"> <li>• The time is only displayed on the display screen in the Camera mode (during shooting). (☞ P159 [Display Screen in Camera Mode] )</li> <li>• Is [System] → [Record Set] → [Time Stamp] set to "On"? To display the date and time, set it to "Off". (☞ P154 [ Time Stamp ] )</li> </ul>
The actual recording time is shorter than the estimated time.	<ul style="list-style-type: none"> <li>• The recordable time may be shorter depending on the shooting conditions or the subject.</li> </ul>
The two camera recorders are not synchronized even though the time codes have been synchronized. (L on the Slave device is not displayed.)	<ul style="list-style-type: none"> <li>• Is the [TC IN/OUT] switch correctly set? (☞ P81 [Synchronizing Time Code on Another Camera] )</li> <li>• Set [System] → [Record Set] → [Record Format] → [A]Frame Rate such that the two camera recorders have the same frame rate. (☞ P151 [A]Frame Rate/ [EXT]Frame Rate) )</li> </ul>
Cannot connect to wireless LAN.	<ul style="list-style-type: none"> <li>• Check the mode of connection and method of setting ([SSID] and [Passphrase] in cases other than WPS). (☞ P179 [Wireless LAN connection ("Internal Wireless LAN" 550 or "USB"-Wireless LAN)]) )</li> <li>• Even if the Passphrase is wrong, "Completed the Setup Wizard. Please Input the Passphrase into Your Device." may appear at the browser setting depending on the type of encryption. Adjust [Passphrase] again.</li> </ul>
The View Remote screen turns black. The screen flickers. The screen freezes. Cannot perform remote operation.	<ul style="list-style-type: none"> <li>• The network path is congested. Wait a while before refreshing (reloading) the web browser.</li> <li>• Clear the cache in your Web browser.</li> </ul>
The clips cannot be uploaded to the FTP server.	<ul style="list-style-type: none"> <li>• Adjust the [Clip Server] settings. (☞ P143 [ Clip Server ] )</li> <li>• If a file size limit is set in the FTP server, set the size limit such that it is larger than the maximum size of the recorded clip.</li> <li>• Take necessary action as described in "[List of FTP Transfer Errors] (☞ P 232)".</li> </ul>
The wireless LAN is disconnected.	<ul style="list-style-type: none"> <li>• The wireless LAN may be disconnected depending on the environment. Change the usage environment.</li> <li>• Connect via wired LAN. (☞ P179 [Wireless LAN connection ("Internal Wireless LAN" 550 or "USB"-Wireless LAN)]) )</li> </ul>
The images and audio sound during live streaming are choppy.	<ul style="list-style-type: none"> <li>• Depending on the connection method to the network and connection environment, streaming may not be possible with the encoding bit rate specified. Please reduce the encoding bit rate.</li> </ul>
GPS signal cannot be received. 550 SPC	<ul style="list-style-type: none"> <li>• Signal reception from GPS satellites may be affected by buildings or trees. Perform positioning preferably at an unobstructed location with a clear view.</li> <li>• Radio wave reception may be affected by weather conditions such as on a cloudy or rainy day.</li> </ul>
The position is not accurate. 550 SPC	<ul style="list-style-type: none"> <li>• The precision error may be up to hundreds of meters if the GPS signal is weak or reflected off surrounding buildings.</li> </ul>

# Specifications

## Terminal Section

### General

Item	Description	
Power	DC 12 V	
Power consumption	Approx. 24.0 W (When recording in the factory default settings using the viewfinder.)	
Mass	Approx. 3.6 kg (With battery attached)	
Allowable operating temperature	0 °C to 40 °C (32 °F to 104 °F)	
Allowable operating humidity	30 %RH to 80 %RH	
Allowable storage temperature	-20 °C to 50 °C (-4 °F to 122 °F)	
Built-in wireless LAN	IEEE802.11a/b/g/n/ac (2.4 GHz/5 GHz band) Encryption method: WPA2	
<b>550</b>		
U model	2.4 GHz	Ch1, 2, 3, 4, 5, 6, 7, 8, 9, 10, 11
	5 GHz USA	Ch36, 40, 44, 48, 52, 56, 60, 64, 100, 104, 108, 112, 116, 120, 124, 128, 132, 136, 140, 149, 153, 157, 161, 165
	5 GHz CANADA	Ch36, 40, 44, 48, 52, 56, 60, 64, 100, 104, 108, 112, 116, 132, 136, 140, 149, 153, 157, 161, 165
E model	2.4 GHz	Ch1, 2, 3, 4, 5, 6, 7, 8, 9, 10, 11, 12, 13
	5 GHz Outside Russia	Ch36, 40, 44, 48, 52, 56, 60, 64, 100, 104, 108, 112, 116, 120, 124, 128, 132, 136, 140
	5 GHz Russia	Ch36, 40, 44, 48, 52, 56, 60, 64, 132, 136, 140, 149, 153, 157, 161, 165

### Video/Audio

Item	Description
[SDI OUT] terminal (480i or 576i: Downconverted 720p/1080i/1080p: embedded audio), BNC (unbalanced)	
3G-SDI, HD-SDI, SD-SDI	Compliant with SMPTE ST424, Compliant with SMPTE ST292, Compliant with SMPTE ST259
3G-SDI, HD-SDI, SD-SDI Embedded audio standard	Compliant with SMPTE ST299, Compliant with SMPTE ST299, Compliant with SMPTE ST272
[HDMI] output terminal	Type A
[INPUT 1/INPUT 2] Terminal (XLR 3-pin)	
[MIC]	-50 dBu, 3 kΩ, XLR (balanced), +48 V output (phantom power supply)
[LINE]	+4 dBu, 10 kΩ, XLR (balanced)
[AUX] terminal	-22 dBu, 10 kΩ, 3.5 mm stereo mini jack (unbalanced)
[Ⓜ] Terminal	Φ3.5 mm stereo mini jack

## Others

Item	Description
[LAN] terminal (RJ-45)	100BASE-TX/1000BASE-T
[HOST] terminal	USB-A type, network connection function only
[REMOTE] terminal	Φ2.5 mm mini jack (Stereo)
[TC IN/OUT] terminal	
[IN]	1.0 V(p-p) to 4.0 V(p-p) high impedance
[OUT]	2.0 ± 1.0 V (p-p) low impedance

## Camera Section

Item	Description
Image pickup device	1" single CMOS sensor (effective resolution: approx. 9.35 megapixels)
Sync system	Internal sync (built-in SSG)
ND filter	OFF, 1/4, 1/16, 1/64
Gain	-6 dB, -3 dB, 0 dB, 3 dB, 6 dB, 9 dB, 12 dB, 15 dB, 18 dB, 21 dB, 24 dB, Lolux (30 dB, 36 dB), AGC
Electronic shutter	1/6 to 1/10000, EEI
LCD Monitor	3.97" LCD (800x480)
Viewfinder	0.4" 4:3 Quad-VGA (1280x960)
Lens	F2.8 to F4.5, 20x zoom, f = 9.43 mm to 188.6 mm (35 mm equivalent: 28.0 mm to 560.0 mm)
Filter diameter	Φ82 mm
Sensitivity	F11, 2000 lx (standard value: 60 Hz)

## Storage Section

Item	Description
Supported media	SDHC/SDXC: SD slots x 2 M.2 SSD: Expansion slot



## Video/Audio

Item	Description
4K EXT (SSD) mode (Apple ProRes)	
Recording file format	QuickTime File Format
Video	
422HQ mode	Apple ProRes 422 HQ, 1768 Mbps (Max), 3840x2160/59.94p, 50p, 29.97p, 23.98p, 25p
422 mode	Apple ProRes 422, 1178 Mbps (Max), 3840x2160/59.94p, 50p, 29.97p, 23.98p, 25p
422LT mode	Apple ProRes 422 LT, 821 Mbps (Max), 3840x2160/59.94p, 50p, 29.97p, 23.98p, 25p
Audio	LPCM 2ch, 48 kHz/24 bit
4K mode (MOV: H.264)	
Recording file format	QuickTime File Format
Video	
<b>4:2:2 10</b> XHQ mode	MPEG-4 AVC/H.264, 150 Mbps (Max) 3840x2160/29.97p, 23.98p, 25p
XHQ mode	MPEG-4 AVC/H.264, 150 Mbps (Max) 3840x2160/29.97p, 23.98p, 25p MPEG-4 AVC/H.264, 70 Mbps (Max) 3840x2160/29.97p, 23.98p, 25p
Audio	LPCM 2ch, 48 kHz/16 bit, 24 bit (422 10 bit only)

Item	Description
HD mode (MOV/MXF: MPEG-2) <b>550</b>	
Recording file format	QuickTime File Format (MOV), MXF File Format (MXF)
Video	
HQ mode	MPEG-2 Long GOP VBR, 35 Mbps (Max) MP@HL, 1920x1080/59.94i, 29.97p, 50i, 25p 1440x1080/59.94i, 50i 1280x720/59.94p, 50p
SP mode	MPEG-2 Long GOP CBR, 25 Mbps (Max) MP@H14 1440x1080/59.94i, 50i
Audio	LPCM 2ch, 48 kHz/16 Bit
HD mode (MOV: H.264)	
Recording file format	QuickTime File Format
Video	
<b>4:2:2 10</b> XHQ mode	MPEG-4 AVC/H.264, 70 Mbps (Max) 1920x1080/59.94p, 50p MPEG-4 AVC/H.264, 50 Mbps (Max) 1920x1080/59.94p, 59.94i, 29.97p, 23.98p, 50p, 50i, 25p 1280x720/59.94p, 50p
XHQ mode	MPEG-4 AVC/H.264, 50 Mbps (Max) 1920x1080/59.94p, 59.94i, 29.97p, 23.98p, 50p, 50i, 25p
UHQ mode	MPEG-4 AVC/H.264, 35 Mbps (Max) 1920x1080/59.94i, 29.97p, 23.98p, 50i, 25p 1280x720/59.94p, 50p
Audio	LPCM 2ch, 48 kHz/16 Bit, 24 Bit (422 10 bit only)

Item	Description
HD mode (Exchange (U model) / MP4 (E model): H.264)	
Recording file format	MP4 File Format
Video	
LP mode	MPEG-4 AVC/H.264, 12 Mbps (Max) 1920x1080/59.94p (U model), 1920x1080/50p (E model), MPEG-4 AVC/H.264, 8 Mbps (Max) 1280x720/59.94p (U model) 1280x720/50p (E model)
Audio	AAC 2ch, 48 kHz/16 Bit 128 kbps

#### HD mode (High-Speed)

Item	Description
Recording file format	QuickTime File Format
Video	
 XHQ mode	MPEG-4 AVC/H.264, 70 Mbps (Max), 1920x1080 119.88/59.94p, 100/50p MPEG-4 AVC/H.264, 50 Mbps (Max), 1920x1080 119.88/59.94p, 100/50p, 119.88/29.97p, 100/25p, 119.88/23.98p
XHQ mode	MPEG-4 AVC/H.264, 50 Mbps (Max), 1920x1080 119.88/59.94p, 100/50p, 119.88/29.97p, 100/25p, 119.88/23.98p
UHQ mode	MPEG-4 AVC/H.264, 35 Mbps (Max), 1920x1080 119.88/29.97p, 100/25p, 119.88/23.98p
Audio	LPCM 2ch, 48 kHz/16 Bit, 24 Bit (422 10 bit only)

Item	Description
SD mode (MOV: H.264)	
Recording file format	QuickTime File Format
Video	MPEG-4 AVC/H.264, 8 Mbps (Max) 720x480/59.94i (U model) 720x576/50i (E model)
Audio	LPCM 2ch, 48 kHz/16bit
Web mode (MOV: H.264)	
Recording file format	QuickTime File Format
Video	
HQ mode	MPEG-4 AVC/H.264, 8 Mbps (Max) 720x480/59.94i, 720x576/50i MPEG-4 AVC/H.264, 3 Mbps (Max) 960x540/29.97p, 25p, 23.98p
LP mode	MPEG-4 AVC/H.264, 1.2 Mbps (Max) 480x270/29.97p, 25p, 23.98p
Audio	LPCM 2ch, 48 kHz/16 Bit (720x480, 720x576) μ-law 2ch, 16 kHz (960x540, 480x270)
Streaming mode	
Video	MPEG-4 AVC/H.264 1920x1080/59.94p, 50p 24/20/16/12/8 Mbps (Max) 1920x1080/59.94i, 50i, 29.97p, 25p 20/16/12/8/5/3 Mbps (Max) 1280x720/59.94p, 50p 20/16/12/8/5/3 Mbps (Max) 1280x720/29.97p, 25p 8/5/3/1.5 Mbps (Max) 720x480/59.94i 720x576/50i 8/5/3/1.5/0.8/0.3 Mbps (Max) 640x360/59.94p, 50p 3/1.5 Mbps (Max) 640x360/29.97p, 25p 3/1.5/0.8/0.3 Mbps (Max)
Audio	AAC 2ch, 128/64 kbps

## Accessories

Accessories	
Warranty Card (U model only)	1
INSTRUCTIONS (BASIC)	1
AC Adapter	1
Power Cord (U model: 1, E model: 2)	
Battery	1
Wireless LAN Antenna <b>550</b>	2

\* A large eyecup and hood are mounted in advance to the camera body.

## Dimensional Outline Drawing (Unit: mm)

Wireless LAN antenna is not included in GY-HC500U/GY-HC500E/GY-HC500SPCU.

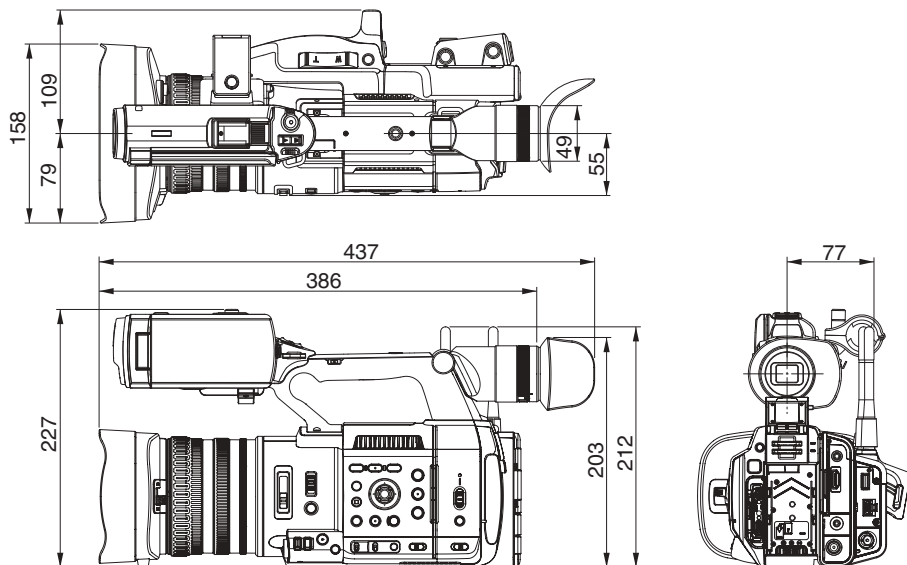

\* The specifications and appearance of this product are subject to changes for further improvement without prior notice.

# Appendix

## Tone Mapping Characteristics for Converting HLG to ITU709 for LCD/VF

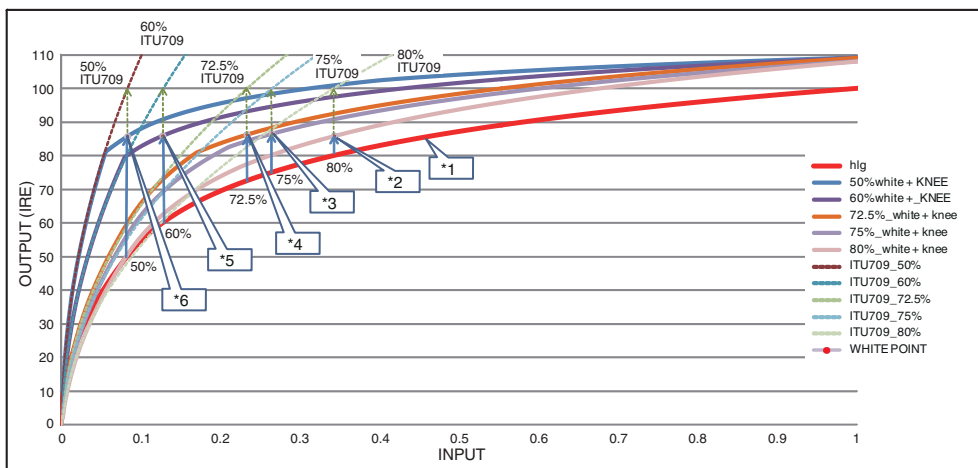

- \*1 HLG
- \*2 White Level  
80% converted
- \*3 White Level  
75% converted
- \*4 White Level  
72.5% converted
- \*5 White Level  
60% converted
- \*6 White Level  
50% converted

# Index

- A**
  - AC adapter ..... 35, 36
  - Action ..... 99
  - AF assist ..... 61, 114
  - Aspect ratio ..... 58
  - Auto FTP ..... 183
- B**
  - Backup rec ..... 89
  - Battery ..... 20, 35
  - Brightness adjustment ..... 64
  - Broadcast Overlay ..... 214
- C**
  - Camera control function ..... 196
  - Camera mode ..... 25, 41, 159
  - Cellular adapter ..... 180
  - Charging time ..... 36
  - Clip continuous rec ..... 92
  - Clip cutter trig (splitting clips) ..... 96
  - Clip name ..... 53, 98
  - Clip review ..... 86
  - Color bar ..... 169
  - Color matrix ..... 171
  - Connection settings file ..... 201
  - Continuous operating time ..... 36
- D**
  - Deleting clips ..... 102
  - Digital Extender ..... 113
  - Display screen ..... 41, 159, 165
  - Dual rec ..... 88
  - Dynamic zoom ..... 59, 113
- E**
  - Electronic shutter ..... 67
  - Error message ..... 72, 231
  - Expanded focus ..... 62
  - External monitor ..... 175
- F**
  - Face detection ..... 62, 161
  - Favorites menu ..... 155
  - FAW (Full Auto White Balance) ..... 69, 117
  - FEC Matrix ..... 209
  - File format ..... 56
  - Focus ..... 60
  - Focus assist ..... 61
  - Formatting (Initializing) of Recording Media ..... 51
  - Frame rec ..... 94
  - FTP Resume ..... 186
  - FTP server ..... 100, 180, 182
  - Full Screen Graphic ..... 145, 216
- G**
  - Gain adjustment ..... 66
  - GPS ..... 85, 148
- H**
  - Hard Lock ..... 73, 111
  - Headphone ..... 76, 176
  - High-Speed ..... 56, 149
  - Histogram ..... 87, 127
- I**
  - IFB ..... 211
  - Image stabilizer ..... 73
  - Infrared Recording ..... 96, 113
  - Initial settings ..... 39
  - Interval rec ..... 95
  - Iris adjustment ..... 65
- L**
  - LCD monitor ..... 22, 37, 41, 43
  - Lens cover ..... 33
  - Live streaming ..... 204
- M**
  - Manual FTP ..... 183
  - Marker display ..... 169
  - Media mode ..... 25, 41, 165
  - Menu ..... 107, 108, 110
  - Metadata ..... 180, 187
  - MF Assist ..... 61, 115
- N**
  - ND filter ..... 68
  - Network ..... 135, 177
  - NETWORK LED ..... 47, 148
  - Network operating environment ..... 178
- O**
  - OK mark ..... 103
  - One push auto focus ..... 60
  - Operation lock ..... 54
  - Overlay ..... 144, 214, 219
- P**
  - Picture quality setting ..... 73
  - Power ..... 37, 38
  - Pre rec ..... 91
  - Preset zoom (browser) ..... 195
  - Preset zoom (camera) ..... 59
  - Push auto focus ..... 60
- R**
  - Rec Trigger (HDMI OUT) ..... 132, 163
  - Rec Trigger (SDI OUT) ..... 130, 163
  - Recordable time ..... 48, 49
  - Recording simultaneously at two different definitions ..... 87
  - Remote edit mode ..... 25, 42
  - Repairing the Recording Media ..... 52
  - Resolution ..... 56
  - Return Audio ..... 211
  - Return over IP ..... 139, 210
  - Return Videos ..... 210

<b>S</b>	Safety zone display .....	169
	Scoreboard Overlay .....	219
	SD/SDHC/SDXC card .....	21, 48
	SDI .....	175
	SDP Generator .....	214
	Selecting multiple clips .....	104
	Series rec .....	87
	Setting the date/time .....	40
	Setup file .....	172
	Shooting .....	55
	Software keyboard .....	109
	Sportzcast .....	146, 229, 235
	Spot meter .....	83
	SSD .....	48, 49, 51, 149
	STATUS LED .....	47, 148
	Status screen .....	42, 167
	Switching shutter speed .....	67
<b>T</b>	Tagging .....	212
	Tally lamp .....	47, 236
	Thumbnail (detailed screen) .....	99
	Thumbnail (standard screen) .....	97
	Thumbnail screen .....	97
	Time code .....	76, 77
	Time code generator .....	77
	Time code playback .....	101
	Trimming .....	106
<b>U</b>	User button .....	46
	User's bit .....	76
<b>V</b>	Video format .....	56
	View remote .....	196
	Viewfinder .....	22, 37, 41, 44
<b>W</b>	Warning .....	42, 236
	Watermark .....	145, 216
	Web browser .....	186, 190, 198
	White balance adjustment .....	69
	White paint .....	72
	Wired LAN .....	179
	Wired remote control .....	176
	Wireless LAN .....	34, 179
	Wizard .....	136
<b>Z</b>	Zebra pattern .....	82
	Zoom .....	59
<b>Symbol</b>		
	4K .....	56, 149

# Software License Agreement

The software embedded in the Product (hereinafter the “Licensed Software”) provided by JVCKENWOOD Corporation (hereinafter the “Licensor”) is copyrighted to or sublicensable by the Licensor, and this Agreement provides for the terms and conditions which Users shall follow in order to use the Licensed Software. The User shall use the Licensed Software by agreeing with the terms of this Software License Agreement. This Agreement shall be deemed completed at the time the User (hereinafter the “User”) initially used the Product in which the “Licensed Software” is embedded. The Licensed Software may include the software which has been licensed to the Licensor directly or indirectly from any third party. In such case, some third parties require the Users to follow their conditions for use separately from this Software License Agreement. Such software shall not be subject to this Agreement, and the Users are urged to read the “[Important Notice concerning the Software] (P 249)” to be provided separately.

## Article 1 General Provision

The Licensor shall grant to the User a non-exclusive and non-transferable (other than the exceptional case referred to in Article 3, Paragraph 1) licensed to use the Licensed Software within the country of the User (the country where the User bought the Product (hereinafter the “Country”)).

## Article 2 License

1. The license granted under this Agreement shall be the right to use the Licensed Software in the Product.
2. The User shall not duplicate, copy, modify, add, translate or otherwise alter, or lease the Licensed Software and any related documents, whether in whole or in part.
3. The use of the Licensed Software shall be limited to personal purpose, and the Licensed Software shall not be distributed, licensed or sub-licensed whether it is for commercial purpose or not.
4. The User shall use the Licensed Software according to the directions described in the operation manual or help file, and is prohibited to use or duplicate any data in a manner violating the Copyright Law or any other laws and regulations by applying whole or a part of the Licensed Software.

## Article 3 Conditions for Grant of License

1. When the User transfers the Product, it may also transfer the license to use the Licensed Software embedded in the Product (including any related materials, updates and upgrades) on condition that no original, copies or related materials continue in the possession of the User, and that the User shall cause the transferee to comply with this Software License Agreement.
2. The User shall not carry out reverse engineering, disassembling, decompiling or any other code analysis works in connection with the Licensed Software.

## Article 4 Right pertaining to the Licensed Software

1. Any and all copyrights and other rights pertaining to the Licensed Software and related documents shall belong to the Licensor or the original holder of the right who granted to the Licensor the license or sublicense for the Licensed Software (hereinafter the “Original Rightholder”), and the User shall not be entitled to any right other than the license granted hereunder, in respect of the Licensed Software and any related documents.
2. The User shall, whenever the User uses the Licensed Software, comply with any laws relating to the copyright and other intellectual property rights.

## Article 5 Indemnification of Licensor

1. Neither the Licensor nor the Original Rightholder shall be liable for any damage incurred by the User or any third party due to the exercise of the license granted to the User under this Agreement, unless otherwise restricted by law.
2. The Licensor will offer no guarantee for the merchantability, convertibility and consistency with certain objective of the Licensed Software.

## Article 6 Liability to Third Party

If any dispute has arisen with any third party due to an infringement upon a copyright, patent or any other intellectual property right that was caused by the User’s use of the Licensed Software, the User shall settle such dispute at the User’s own cost and hold the Licensor and the Original Rightholder harmless from any inconvenience it may cause.

## Article 7 Confidentiality

The User shall keep the confidentiality of such portion of the Licensed Software, related documents thereof or any other information to be granted under this Agreement, as well as the conditions of this Agreement as has not yet entered the public domain, and shall not disclose or divulge the same to any third party without approval of the Licensor.

## Article 8 Termination

In case the User falls under any of the events described in the following items, the Licensor may immediately terminate this Agreement or claim that the User compensates for the damage incurred by the Licensor due to such event:

- (1) when the User violated any provision of this Agreement; or
- (2) when a petition has been filed against the User for an attachment, provisional attachment, provisional disposition or any other compulsory execution.



## Article 9 Destruction of the Licensed Software

If this Agreement is terminated pursuant to the provision of Article 8, the User shall destroy the Licensed Software, any related documents and copies thereof within two (2) weeks from such date of termination.

## Article 10 Export Restriction

1. The User shall understand that the Licensed Software shall be subject to the export restrictions adopted by the country of User and any other countries.
2. The User shall agree that the software will be subject to any and all applicable international and domestic laws including the export control regulation of the country of User and any other countries, and any restrictions concerning the end-users, the use by end-users and importing countries to be provided by the country of User and any other countries, and any other governmental authorities.
3. If the User is an agency of the United States of America (the "Government"), the User acknowledge Licensor's representation that the Licensed Software is a "Commercial Item" as defined in Federal Acquisition Regulation (FAR) part 2.101(g) consisting unpublished "Commercial Computer Software" as those items are used at FAR part 12.212 and is only license the User with the same use right Licensor grants all commercial end users pursuant to the terms of this Agreement.

## Article 11 Miscellaneous

1. In the event any part of this Agreement is invalidated by operation of law, the residual provisions shall continue in force.
2. Matters not stipulated in this Agreement or any ambiguity or question raised in the construction of this Agreement shall be provided or settled upon good-faith consultation between the Licensor and the User.
3. The Licensor and the User hereby agree that this Agreement is governed by the laws of Japan, and any dispute arising from, and relating to the rights and obligations under, this Agreement shall be submitted to the exclusive jurisdiction of the Tokyo District Court for its first instance.

# Important Notice concerning the Software

## Software License Attached to the Product :

The Software embedded in the Product is composed of several independent software components, and in each of such individual components (hereinafter the "Licensed Software"), a copyright of either JVCKENWOOD Corporation (hereinafter "JKC") or a third party subsists.

The Product uses the software component designated in the End-User License Agreement that was executed between JKC and a third party (hereinafter "EULA").

The Licensed Software covers those corresponding to free software, and, as a condition of distribution of the software component in executable format which is based on the license granted under the GNU General Public License or Lesser General Public License (hereinafter "GPL/LGPL"), it requires an availability of the source code for the relevant component. Please refer to the following URL concerning the distribution of the source code;

<https://www3.jvckenwood.com/english/download/gpl/index.html>

Please note that we are unable to answer any inquiry relating to the contents, etc. of the source code. In addition, the Licensed Software includes the software developed or created independently by JKC and there exists an ownership of JKC in such software and any accompanying documents, which is protected by the Copyright Law, any international treaties and other applicable laws. As to matters concerning the handling by JKC of the software components, please refer to the "Software License Agreement" attached hereto. Please note that any software component licensed under "EULA" which is not subject to "GPL/LGPL", and those developed or created independently by JKC shall not be subject to the requirement for provision of the source code. The software component distributed under "GPL/LGPL" shall be licensed to users without charge, and, therefore, no warranty is given for such software component, either express or implied, within the scope of the applicable laws and regulations. Unless otherwise permitted by applicable laws and regulations or agreed in written form, none of the owners of the copyright or persons entitled to alter or redistribute the software component under the said license shall have any liability for any type of damage or loss resulting from the use of or inability to use such software component. For further details of the conditions of use of such software component or matters required to be complied with, please refer to the relevant "GPL/LGPL".

Users are urged to read the details for the relevant license carefully before using the software component covered by "GPL/LGPL" and embedded in the Product. Since the terms and conditions of individual licenses are provided by parties other than JKC, the original English version will be displayed by the Product.

- ① Turn on the power.
- ② Press the [MENU/THUMB] button.
- ③ Select [System] → [System Information] → [Open Source License].





GY-HC550U/GY-HC550E  
GY-HC500U/GY-HC500E  
GY-HC500SPCU  
4K MEMORY CARD CAMERA RECORDER

**JVC**