

# JVC

## MULTI FORMAT LCD MONITOR

### DT-U31

### DT-U27HB

### DT-U31PRO

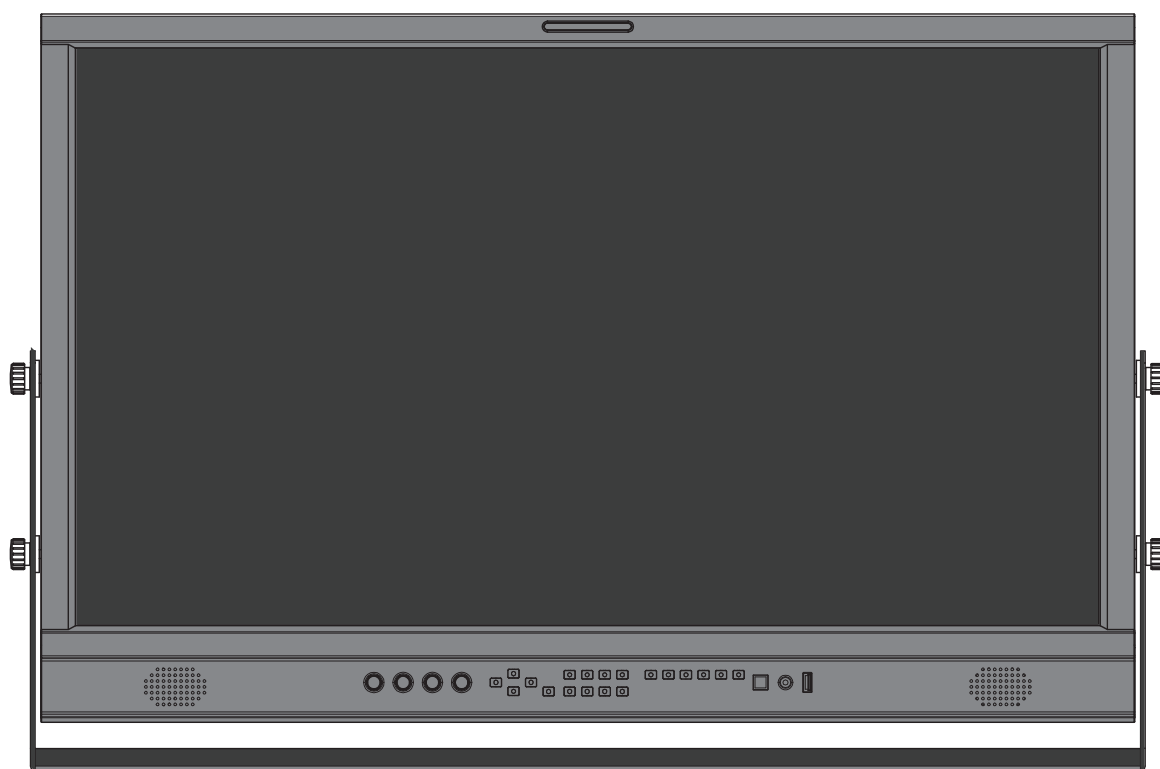

## INSTRUCTIONS



For Customer Use:  
Please read the Instruction Manual carefully  
and retain this information for future reference.

Version: B

# Safety Precautions

 <b>CAUTION</b> <b>RISK OF ELECTRICAL SHOCK</b> <b>DO NOT OPEN</b> 	<p>The lightning flash with arrowhead symbol, within an equilateral triangle is intended to alert the user to the presence of uninsulated “dangerous voltage” within the product’s enclosure that may be of sufficient magnitude to constitute a risk of electric shock to persons.</p> <p>The exclamation point within an equilateral triangle is intended to alert the user to the presence of important operating and maintenance (servicing) instructions in the literature accompanying the appliance.</p>
<p><b>CAUTION:</b> To reduce the risk of electric shock. Do not remove cover (or back). No user serviceable parts inside. Refer servicing to qualified service personnel.</p>	

**WARNING:** TO REDUCE RISK OF FIRE OR ELECTRIC SHOCK, DO NOT EXPOSE THIS APPARATUS TO RAIN OR MOISTURE. NO OBJECTS FILLED WITH LIQUIDS, SUCH AS VASES, SHALL BE PLACED ON THE APPARATUS.

**Warning:** This is a class A product. In a domestic environment this product may cause radio interference in which case the user may be required to take adequate measures.

## IMPORTANT SAFEGUARDS

Electrical energy can perform many useful functions. This unit has been engineered and manufactured to assure your personal safety. But **IMPROPER USE CAN RESULT IN POTENTIAL ELECTRIC SHOCK OR FIRE.** In order not to defeat the safeguards incorporated into this product, observe the following basic rules for its installation, use, and service. Please read these “IMPORTANT SAFEGUARDS” carefully before use.

- All the safety and operating instructions should be read before the product is operated.
- The safety and operating instructions should be retained for future reference.
- All warnings on the product and in the operating instructions should be adhered to.
- All operating instructions should be followed.

### POWER CONNECTION

The power supply voltage rating of this product is AC 120 V (For U.S.A. and Canada) and AC 220 – 240 V (For European countries, Asian countries, and United Kingdom).

The power cord attached conforms to the following power supply voltage and countries. Use only the power cord designated to ensure safety and EMC regulations of each countries.

For U.S.A. and Canada: AC 120 V

For European and Asian countries:  
AC 220 – 240 V

For United Kingdom: AC 220 – 240 V

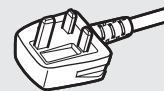
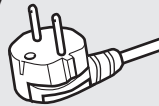

This plug will fit only into a grounded power outlet. If you are unable to insert the plug into the outlet, contact your electrician to install the proper outlet. Do not defeat the safety purpose of the grounded plug.

- This product should be operated only with the type of power source indicated on the label. If you are not sure of the type of power supply of your home, consult your product dealer or local electric power company.

**Warning:**

- Do not use the same power cord for AC 120 V as for AC 220 – 240 V. Doing so may cause malfunction, electric shock or fire.

# Safety Precautions (cont.)

## Under the following conditions,

1. Turn off the power.
2. Unplug this product from the wall outlet.
3. Refer service to qualified service personnel.
  - a) When the product emits smoke or unusual smell.
  - b) When the product exhibits a distinct change in performance—for example, no picture or no sound.
  - c) If liquid has been spilled, or objects have fallen on the product.
  - d) If the product has been exposed to rain or water.
  - e) If the product has been dropped or damaged in any way.
  - f) When the power supply cord or plug is damaged.

- Make enough room for inserting or removing the power plug. Place the product as close to an AC outlet as possible. The main power supply for the product is controlled by inserting or removing the power plug.
- When you install the product in a place where you cannot easily insert or remove the power plug from an AC outlet, do not use the provided power cord holder, and insert or remove the power cord from the AC inlet on the product.
- When the product is left unattended and unused for a long period of time, unplug it from the wall outlet and disconnect the cable system.
- Do not overload wall outlets, extension cords, or convenience receptacles on other equipment as this can result in a risk of fire or electric shock.
- Use only the accessory cord designed for this product to prevent shock.

- Do not install this product in the following places:
  - in a damp or dusty room
  - where the product is exposed to soot or steam, such as near the cooking counter or a humidifier
  - near heat sources
  - where condensation easily occurs, such as near the window
- Do not place this product on an unstable cart, stand, or table. The product may fall, causing serious injury to a child or adult, and serious damage to the product.

The product should be mounted according to the manufacturer's instructions, and should use a mount recommended by the manufacturer.
- Do not use this product near water.
- Be sure to install the product in the place where proper temperature and humidity are kept.

This product becomes hot during its use. Take enough care when handling the product.

Do not attempt to service this product yourself, as opening or removing covers may expose you to dangerous voltages and other hazards. Refer all service to qualified service personnel.

Do not use the product for a long time if the sound is distorted.

- When the product is left unattended and unused for a long period of time, unplug it from the wall outlet and disconnect the cable system.
- Do not overload wall outlets, extension cords, or convenience receptacles on other equipment as this can result in a risk of fire or electric shock.

- Slots and openings in the cabinet are provided for ventilation. These ensure reliable operation of the product and protect it from overheating. These openings must not be blocked or covered.
- Never push objects of any kind into this product through openings as they may touch dangerous voltage points or short-circuit the parts, which could result in a fire or electric shock.
- Never spill liquid of any kind on the product.
- Never place anything on the product. (Placing liquids, naked flames, cloths, paper, etc. on the product may cause a fire.)
- Do not apply any strong shock to the LCD panel. (Do not hit any object against it or push it with a sharp-pointed tool.)
- Do not put heavy objects on the product.
- Do not step on or hang on the product.

- Before connecting other products such as VCR's and personal computers, you should turn off the power of this product for protection against electric shock.
- Do not use attachments not recommended by the manufacturer as they may be hazardous.
- When replacement parts are required, be sure the service technician has used replacement parts specified by the manufacturer or equivalents. Unauthorized substitutions may result in fire, electric shock, or other hazards.
- Upon completion of any service or repairs to this product, ask the service technician to perform safety checks to determine that the product is in proper operating condition.

# Operating Precautions

## IMPORTANT SAFETY INSTRUCTIONS

- 1) Read these instructions.
- 2) Keep these instructions.
- 3) Heed all warnings.
- 4) Follow all instructions.
- 5) Do not use this apparatus near water.
- 6) Clean only with dry cloth.
- 7) Do not block any ventilation openings. Install in accordance with the manufacturer's instructions.
- 8) Do not install near any heat sources such as radiators, heat registers, stoves, or other apparatus (including amplifiers) that produce heat.
- 9) Do not defeat the safety purpose of the polarized or grounding-type plug. A polarized plug has two blades with one wider than the other. A grounding type plug has two blades and a third grounding prong. The wide blade or the third prong are provided for your safety. If the provided plug does not fit into your outlet, consult an electrician for replacement of the obsolete outlet.
- 10) Protect the power cord from being walked on or pinched particularly at plugs, convenience receptacles, and the point where they exit from the apparatus.
- 11) Only use attachments/accessories specified by the manufacturer.
- 12) Use only with the cart, stand, tripod, bracket, or table specified by the manufacturer, or sold with the apparatus. When a cart is used, use caution when moving the cart/apparatus combination to avoid injury from tip-over.
- 13) Unplug this apparatus during lightning storms or when unused for long periods of time.
- 14) Refer all servicing to qualified service personnel. Servicing is required when the apparatus has been damaged in any way, such as power-supply cord or plug is damaged, liquid has been spilled or objects have fallen into the apparatus, the apparatus has been exposed to rain or moisture, does not operate normally, or has been dropped.
- 15) Apparatus shall not be exposed to dripping or splashing and no objects filled with liquids, such as vases, shall be placed on the apparatus.
- 16) Batteries shall not be exposed to excessive heat such as sunshine, fire or the like.
- 17) When discarding batteries, environmental problems must be considered and the local rules or laws governing the disposal of these batteries must be followed strictly.



The LCD panel and backlight have life expectancy. Due to the basic characteristics of the LCD panel, an afterimage or uneven display may occur. It is recommended that you change images occasionally, activate the power saving function, or often turn off the power to reduce the load on the LCD panel. Continuous operations of the LCD panel may accelerate the deterioration.

## Maintenance

**Unplug this product from the wall outlet before cleaning.**

### LCD panel

To avoid irreparable change in appearance of the screen such as uneven color, discoloration, scratches, be careful about the following:

- Do not paste or stick anything using any glues or adhesive tapes.
- Do not write anything on the screen.
- Do not strike the screen with a hard object.
- Avoid condensation on the screen.
- Do not wipe the screen with any liquid such as water. In addition, wiping the screen with water-diluted neutral detergent or solvent such as alcohol, thinner, or benzene may affect the anti-reflection treatment of the screen.
- Do not wipe the screen forcefully.

Wipe stains off the LCD panel with a soft cloth. If the screen gets heavily stained, wipe it with a soft cloth soaked in water-diluted neutral detergent and wrung well, then wipe with a soft dry cloth.

### Cabinet

To avoid the deterioration or damages of the cabinet such as its paint's peeling away, be careful about the following:

- Do not wipe the cabinet using solvent such as alcohol, thinner, or benzene.
- Do not expose the cabinet to any volatile substance such as insecticides.
- Do not allow any rubber or plastic in contact for a long time.
- Do not wipe the cabinet forcefully.

Wipe stains off the cabinet with a soft cloth. If the cabinet gets heavily stained, wipe it with a soft cloth soaked in water-diluted neutral detergent and wrung well, then wipe with a soft dry cloth.

### Ventilation openings

Use a vacuum cleaner to get rid of the dust around the intakes (all the openings). If a vacuum cleaner is not available, use a cloth and wipe it off. Leaving the dust around the intakes may prevent proper temperature control and cause damage to the product.

# Table of Contents

Safety Precautions.....	2
IMPORTANT SAFEGUARDS	2
Operating Precautions.....	4
Maintenance	4
Installation .....	6
Index of Parts and Functions .....	7
Rear panel	7
Front panel	8
Showing Input Signals .....	9
On the Information Display	9
On the Status Display	9
Menu Configuration .....	10
The operation procedure	10
Menu Transition Diagram	10
Main Menu	11
Specifications .....	20
General	20
LCD panel	20
Input/output terminals	20
Dimensions	21
Available signals	22

\* This manual is applicable to DT-U27HB, DT-U31 and DT-U31PRO, and the schematic diagram is taken as the appearance diagram of DT-U31. Any specification, appearance, this manual will be additional text description.

# Installation

- Do not rest your arm on the monitor or lean against the monitor.
- Do not touch the LCD panel when installing the monitor.
- Be sure to install the monitor securely to prevent the monitor from falling over, which may cause damage to the monitor or injury.

## Using the monitor on U-stand

The monitor package provides a U shape rotatable desktop stand to be installed.

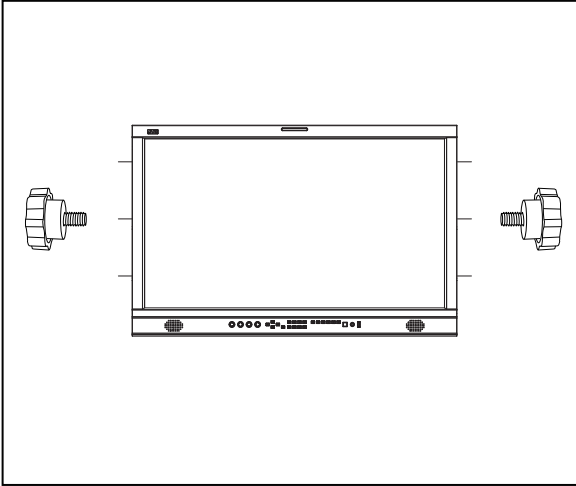

Fix 2 screws to the center screw holes of left and right side.

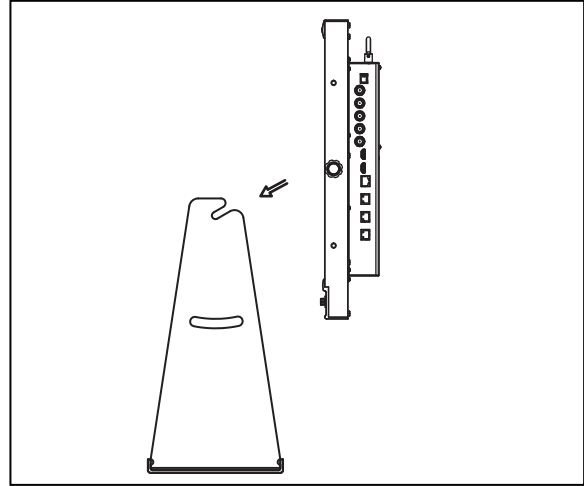

Slide the monitor into the top mouth of U shape stand.

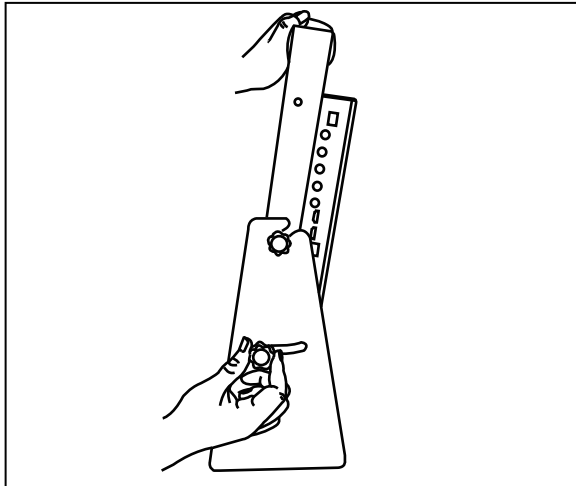

Fix the other 2 screws to the downside screw holes.

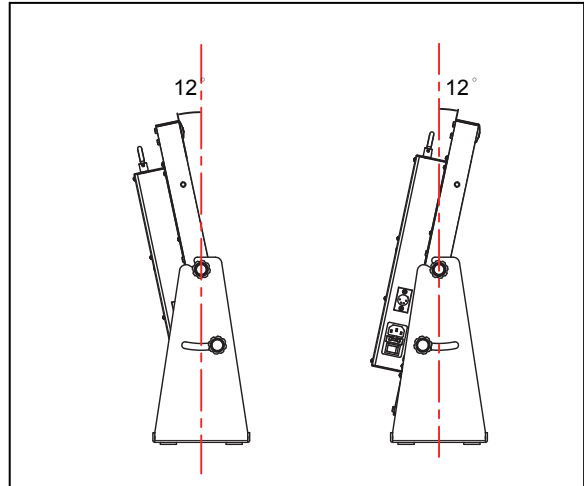

Adjust monitor angle of  $\pm 12^\circ$  by the downside screws.

### Caution:

- Be careful not to pinch your fingers in the moving parts.
- The Max tilt angle is down  $12^\circ$  and up  $12^\circ$ , please make sure the setup location is stable, to prevent the monitor falling down.
- Place the monitor on a mat to avoid scratching the table surface.

# Index of Parts and Functions

## Rear panel

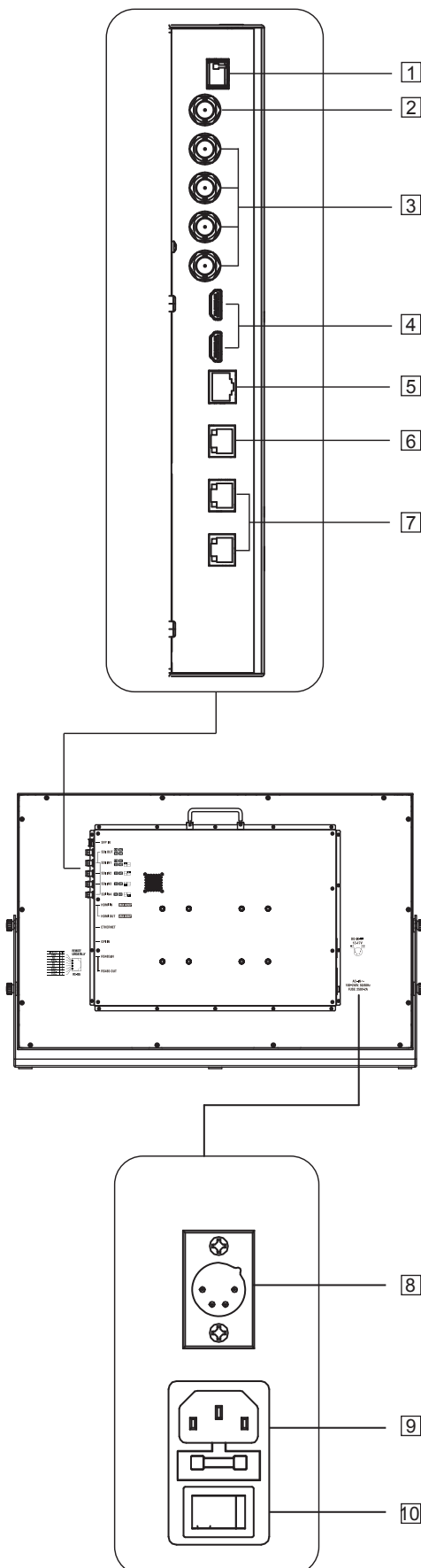

- 1 SFP terminal**  
 Input terminal for 12G/6G/3G/HD/SD-SDI SFP optical fiber receiver adaptor.  
 ● The SFP adaptor is optional purchased.
- 2 E. AUDIO SDI (OUT) terminal (BNC)**  
 Output terminal for the SDI IN1 or SFP IN signal, supports 12G/6G/3G/HD/SD.
- 3 E. AUDIO SDI (IN) terminals (BNC)**  
 Input terminals for the SDI signals:  
 SDI IN1: 12G/6G/3G/HD/SD  
 SDI IN2/3/4: 3G/HD/SD  
 ● The SDI terminals accept also EMBEDDED AUDIO signals including up to 16 audio channels with a sampling frequency of 48 kHz.
- 4 HDMI terminal**  
 Input / Output terminal for HDMI signals.  
 ● Will not display or output HDCP protected contents.
- 5 ETHERNET**  
 1000M high speed RJ45 ethernet port, for webserver IP external control. (☞ page 17)
- 6 GPI terminal**  
 Terminal for controlling the monitor by GPI remote. (☞ Page 16.)
- 7 RS485 UMD terminal**  
 Terminal for controlling the monitor by TSL UMD Tallyman system. (☞ Page 17.)
- 8 DC-IN terminal** (Only DT-U31 has DC-IN.)  
 Connect with DC12V-17V 4-pin XLR power adaptor.  
 (Pin 1: Negative, Pin 4: Positive)  
 ● Make sure the DC adaptor load matches with the power consumption of the monitor.
- 9 AC-IN terminal**  
 Connect the provided AC power cord to an AC outlet, support AC 100-240V, 50/60Hz, with 250V fuse.
- 10 AC Switcher**  
 Switch to OFF will cut off AC power completely.

### Note for connections

- Before making any connections, turn off all the equipment.
- User a cord whose plugs correctly match the terminals on this monitor and the equipment.
- Plugs should be firmly inserted; poor connections could cause noise.
- When unplugging a cord, be sure to grasp its plug and pull it out.
- DO NOT connect the power cord until all connections are complete.
- Refer also to the user manual of each piece of equipment.

# Index of Parts and Functions (cont.)

## Front panel

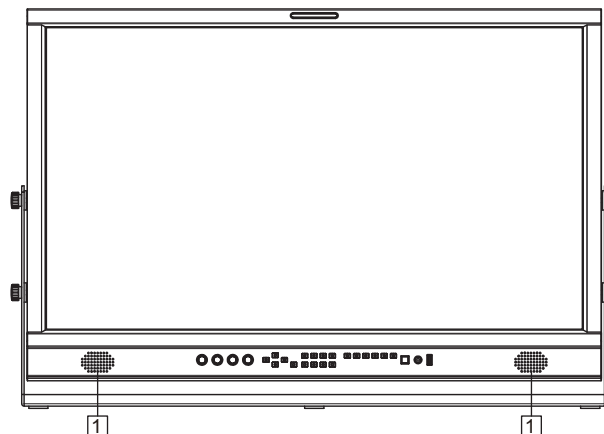

### Tally lamp

This lamp is controlled by the tally function of the Make contact terminal. ( [↖](#) Page 16.)

You can select the color of the tally lamp from "Green", "Red", or "Yellow".

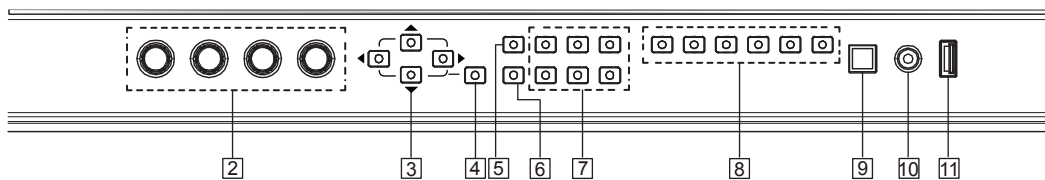

### 1 Speaker:

- For SDI/HDMI embedded audio monitoring.
- The speaker will not work if earphone is plugged in.

### 2 Rotary knobs:

- VOLUME: Adjust the sound volume from 0-100.
- Press down the VOLUME knob, the volume will be 0 (mute).
- CHROMA: Adjusts the picture chroma from -100 to +100.
- BRIGHT: Adjusts the picture brightness from -100 to +100.
- CONTRAST: Adjusts the picture contrast from -100 to +100.
- Press down the BRIGHT/CONTRAST/SATURATION knobs, the parameters will recover to default value 0.

### 3 Direction Keys:

- Includes Up, Down, Left, Right 4 direction keys for Menu operation. ( [↖](#) page 10.)

### 4 Menu Key:

- Press to switch on Menu system and operate by direction keys.

### 5 WFM Key:

- Press to switch on/off the Waveform scope.

### 6 INFO Key

- Press to switch on/off all the on screen overlay informations, includes video scopes, audio meters, UMD, timecode, markers etc.
- Press INFO can quit Menu system at any time.

### 7 FUNCTION Keys

- Provide F1 / F2 / F3 / F4 / F5 / F6 function keys to assign monitor functions and switch on/off quickly. ( [↖](#) page 19.)

### 8 INPUT SELECTION keys

- Select input sources directly:
  - SDI 1 / SFP: Press to switch to the SDI IN-1 terminal input, Press again to switch to SFP terminal input.
  - SDI 2: Press to switch to the SDI IN-2 terminal input.
  - SDI 3: Press to switch to the SDI IN-3 terminal input.
  - SDI 4: Press to switch to the SDI IN-4 terminal input.
  - 4x3G: Press to switch to Quad-link 4x3G SDI 2SI interleave mode, Press again to switch to 4x3G SDI Quad split mode.
    - The 4x3G source requires inputs of all SDI IN1,2,3,4.
  - HDMI: Press to switch to HDMI terminal input.
  - The key light will indicate the current input source.

### 9 POWER ON/OFF

- Press to switch on or off the monitor:
  - The standby power consumption is less than 0.5W, comply with ErP rules. To complete cut off power, please switch off the AC input switcher or disconnect DC cable.

### 10 PHONE jack

- 3.5mm earphone socket, for SDI/HDMI embedded audio monitoring.

### 11 USB LUT ( The USB file system only supports FAT32.)

- Firmware upgrade:
  - Plug in USB stick with firmware, operate Menu to upgrade the monitor. ( [↖](#) page 19.)
- User 3DLUT upload:
  - Plug in USB stick with user created LUTs, operate Menu to upload to the monitor. ( [↖](#) page 11.)
- Auto calibration:
  - Plug in color sensor probe into the USB port, operate Menu to start auto calibration. ( [↖](#) page 12.)



# Showing Input Signals

## On the Information Display

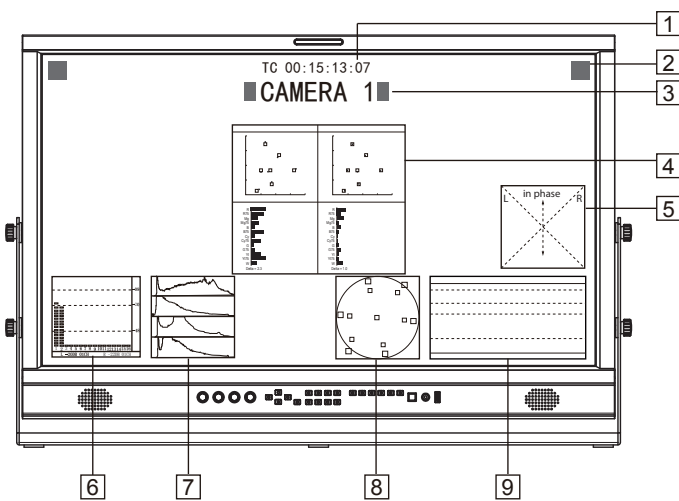

- 1 Time code (SDI)**  
Under SDI input, the monitor can display Time code information (LTC, VITC1&2). If no Time code info is detected, it will display "TC UNLOCKED".
- 2 On screen TALLY**  
Display TALLY signal from GPI port. ( [page 16.](#) )
- 3 UMD**  
Display TSL 3.1/4.0 UMD or User input Source ID. ( [page 17.](#) )
- 4 Color Checker**  
Display color gamut chart and Delta chart for last calibrated value and current measured value. ( [page 12.](#) )
- 5 Lissajous**  
Display audio Lissajous pattern. ( [page 15.](#) )
- 6 Audio VU/PPM meters**  
Display meters of SDI/HDMI embedded audio  
The audio meter on screen positions, markers and background colors are adjustable. ( [page 15.](#) )
- 7 Histogram**  
Parallel display R/G/B/Y histogram for SDI and HDMI video. ( [page 14.](#) )
- 8 Vector scope**  
Display vector scope with 100% and 75% markers for SDI and HDMI video. The vector scope pattern display positions, colors, background are adjustable. ( [page 14.](#) )
- 9 Waveform**  
Display waveform scopes for SDI and HDMI video with markers. The display waveform can be selected from Y/Cb/Cr/ R/G/B /RGB types, and single line display mode selectable. The waveform display positions, colors, background are adjustable. ( [page 14.](#) )

## On the Status Display

Main Menu	Status	
Exit&Status >	Channel	XXX <b>1</b>
Picture Adjustments >	Format	XX <b>2</b>
Signal and Color >	Video Lumina Range	XXXX <b>3</b>
Signal Scanning >	YUV Color Matrix	XXXX <b>4</b>
Tool & Information >	Processing Color Space	XXX <b>5</b>
Audio >	Color Temperature	XXX <b>6</b>
External Control >	Scanning	XXX <b>7</b>
System Setting >	Loaded Profile	XXX <b>8</b>
	Firmware Version	XXX <b>9</b>

Press "MENU" button, the main menu will pop up from the left top of the screen, and display the current working status, including:

- 1 Channel**  
Display the current displayed input source. Switch on Four-screen Splitter, the channel displays Four-screen.
- 2 Format**  
Display the video format of current input source.
  - If no video detected in current input source, it will display "No Signal"
  - Switch on Four-screen Splitter, the format of 4-channel SDI signals will be displayed respectively.
- 3 Video Lumina Range**  
Display the current set of video lumina level range value.
- 4 YUV Color Matrix**  
Display the current set of YUV color matrix.
- 5 Processing Color Space**  
Display the current set of color space.
- 6 Color Temperature**  
Display the current set of color temperature.
- 7 Scanning**  
Display the current set of scan mode.
- 8 Loaded Profile**  
Display the current loaded user profile.
- 9 System Version**  
Display the current firmware version.

# Menu Configuration

## The Operation Procedure

- 1 Press the "MENU" button to display the Main Menu.
- 2 Press "▲" and "▼" to select submenu, the selected submenu highlights in yellow; Press "▶" to apply and enter into the selected submenu item.
- 3 Press "▲" and "▼" to select the item to be set from the submenu; Press "▶", the selected item and its parameters will be highlighted in yellow.
- 4 Press "▲" and "▼" to adjust the selected item; Press "▶" or "MENU" to apply and save the settings.
- 5 Press "◀" to quit submenu; Press "◀" again to quit the Main Menu.
- 6 Press "INFO" can quit Menu system at any time.

### Note

The items in gray means not available to set up.

If there is no operation in a period of time, the menu will automatically save settings and quit. The menu quit time can be set from OSD submenu.

If Key Inhibit is turned on, except the Key Inhibit submenu, all other items are not available to operate. Please turn off the key inhibit to enable the Menu operation.

## Menu Transition Diagram

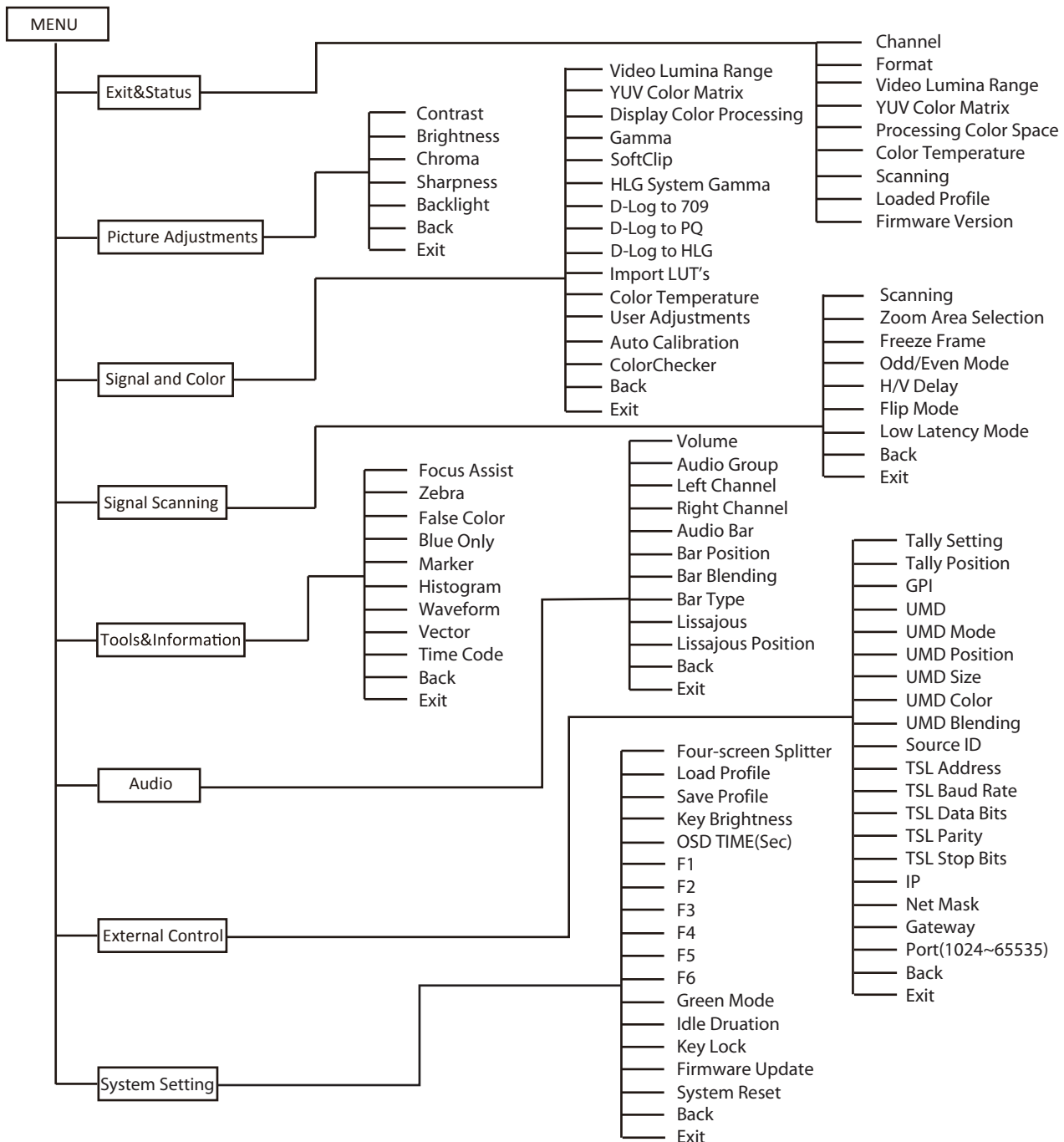

# Menu Configuration (cont.)

## Main Menu

### Picture Adjustments

Setting for the picture preference.

Item	To do	Setting value
Contrast	Adjusts the contrast of the display.	-100 to +100
Brightness	Adjusts the brightness of the display.	-100 to +100
Chroma	Adjusts the saturation of the display.	-100 to +100
Sharpness	Adjusts the sharpness of the display.	0 to 100
Backlight	Adjusts the backlight of the display.	0 to 100
Back	Return to previous menu	
Exit	Exit Main Menu	

### Signal and Color

Settings about video colors

Item	To do	Setting value	
Video Lumina Range	Select a range to match with input video *1	0-1023, 4-1019, 64-940, 64-1023	
YUV Color Matrix	Select the input YUV color matrix	Auto, BT.601, BT.709, BT.2020	
Display Color Processing	Select the color gamut to display	LCD Panel, DCI-P3, Rec.709, Rec.2020	
Gamma	Select the Gamma correction value	1.0, 1.8, 2.2, 2.4, 2.6, PQ1000, HLG1000, S-Log3	
SoftClip *2	Set SoftClip	OFF, ON	
HLG System Gamma*3	Select the HLG System Gamma correction value	1.0, 1.1, 1.2, 1.3, 1.4, 1.5	
D-Log to 709 *4	Select a camera log LUT to convert to REC.709	OFF, J-Log1, Log-C, S-Log2, C-Log, V-Log, RedLogFilm, S-Log3, User-Log	
D-Log to PQ*5	Select a camera log LUT to convert to PQ1000	OFF, ARRI_LogC_PQ, Canon_CLog2Cin_PQ, Canon_CLog3Cin_PQ, Panasonic_VLog_PQ, RED_L3G10_PQ, Sony_SLog3_Cin_PQ, Sony_SLog3_SG3_PQ	
D-Log to HLG*6	Select a camera log LUT to convert to HLG1000	OFF, ARRI_LogC_HLG, Canon_CLog2Cin_HLG, Canon_CLog3Cin_HLG, Panasonic_VLog_HLG, RED_L3G10_HLG, Sony_SLog3_Cin_HLG, Sony_SLog3_SG3_HLG,	
Import LUT's *7	Select a LUT position to upload User created 3DLUT cube	None, 3DLut.cube, User-Log.cube	
Color Temperature	Select a Color Temperature	2000K-10000K (Take a step of 100K) USER 1, USER 2, D55, D65, D75, D93	
User Adjustments	Select a User Temperature and adjust the RGB Gain/Bias value (Only available when Color temperature is set to USER1 or USER2)	User Temp: 2000K-10000K (Take a step of 100K) D55, D65, D75, D93 Red Gain: -100~+100 Red Bias: -100~+100 Green Gain: -100~+100 Green Bias: -100~+100 Blue Gain: -100~+100 Blue Bias: -100~+100	
Auto Calibration *8	Probe Select *9	Select a probe to use	X-rite i1 Pro OEM, Jeti Specbos 1211
	Type	Set calibration time	Quick mode, Precise mode
	Start Calibration*10	Start Calibration	No, Yes
	Measure *11	Measure current color	No, Yes
	Back	Return to previous menu	
Exit	Exit Main Menu		
Color Checker	Switch on the color gamut and display	OFF, ON	
Back	Return to previous menu		
Exit	Exit Main Menu		

# Menu Configuration (cont.)

## \*1 Video Lumina Range

Set Video Lumina Range to match with input video. The default lumina range is 64-940 for broadcast application.

## \*2 Softclip

Only displays in PQ1000. DT-U27HB does not have this menu item.

## \*3 HLG System Gamma

Only displays in HLG1000.

## \*4 D-Log to 709

D-Log to 709 only displays in Rec.709 mode.

Upload Position	Description
3DLut.cube	Re-calibrated 3DLUT cube
J-Log1.cube	JVC J-Log1 to Rec709 3DLUT cube
Log-C.cube	ARRI Log-C to Rec709 3DLUT cube
S-Log2.cube	SONY S-Log2 to Rec709 3DLUT cube
S-Log3.cube	SONY S-Log3 to Rec709 3DLUT cube
C-Log.cube	Canon C-Log to Rec709 3DLUT cube
V-Log.cube	Panasonic V-Log to Rec709 3DLUT cube
RedLogFilm.cube	Red Log to Rec709 3DLUT cube
User-Log.cube	User 3DLUT cube upload
PQ1000.csv	PQ1000 HDR LUT
HLG1000.csv	HLG1000 HDR LUT

## \*5 D-Log to PQ

D-Log to PQ only displays in Rec.2020 with PQ1000 mode.

Upload Position	Description
ARRI_LogC_PQ	ARRI_LogC_PQ to Rec.2020 PQ
Canon_CLog2Cin_PQ	Canon_CLog2Cin_PQ to Rec.2020 PQ
Canon_CLog3Cin_PQ	Canon_CLog3Cin_PQ to Rec.2020 PQ
Panasonic_VLog_PQ	Panasonic_VLog_PQ to Rec.2020 PQ
RED_L3G10_PQ	RED_L3G10_PQ to Rec.2020 PQ
Sony_SLog3_Cin_PQ	Sony_SLog3_Cin_PQ to Rec.2020 PQ
Sony_SLog3_SG3_PQ	Sony_SLog3_SG3_PQ to Rec.2020 PQ

## \*6 D-Log to HLG

D-Log to HLG only displays in Rec.2020 with HLG1000 mode.

Upload Position	Description
ARRI_LogC_HLG	ARRI_LogC_HLG to Rec.2020 HLG
Canon_CLog2Cin_HLG	Canon_CLog2Cin_HLG to Rec.2020 HLG
Canon_CLog3Cin_HLG	Canon_CLog3Cin_HLG to Rec.2020 HLG
Panasonic_VLog_HLG	Panasonic_VLog_HLG to Rec.2020 HLG
RED_L3G10_HLG	RED_L3G10_HLG to Rec.2020 HLG
Sony_SLog3_Cin_HLG	Sony_SLog3_Cin_HLG to Rec.2020 HLG
Sony_SLog3_SG3_HLG	Sony_SLog3_SG3_HLG to Rec.2020 HLG

## \*7 Import LUT's

The monitor has built-in calibrated 3DLUT cube, De-log 3DLUT cube, User 3DLUT cube and PQ1000, HLG1000 HDR LUTs.

To upload user LUT or over write the built-in LUTs:

1. Make sure the 3DLUT format should be 17x17x17 cube, and the 1DLUT format should be csv.
2. Rename the LUT or over write the built-in LUTs: (attention to the cap letters), and copy into USB stick root directory.
3. Insert the USB stick onto monitor USB port on the FRONT panel, select the corresponding upload position to import the new LUT.

# Menu Configuration (cont.)

## \*8 Auto Calibration

The monitor has 3DLUT calibration software built-in, and support the following color sensor probe to directly plug into front USB port.

When start calibration, the monitor will generate standard colors and the color sensor will read the colors one by one and upload result to the monitor by USB connection.

The monitor will comparing the generated colors and sensor read colors, to work out 3DLUT cube and calibrate itself automatically.

## \*9 Probe Select

The monitor support the following probe models:

Brand	Model
X-rite	i1 DISPLAY E0DIS3-DC0E (JVC dedicated version)
JETI	Specbos 1211

## \*10 Start Calibration

Steps:

- (1) Place the monitor into a dark room. Switch on the monitor.
- (2) Plug the color sensor (X-rite i1 or Jeti Specbos 1211) into front USB port of the monitor.
- (3) Enter Auto Calibration - Probe Select to select the correct used color sensor probe.
- (4) Enter Auto Calibration - Type to select quick mode or precise mode.

Calibration time

Sensor probe	Quick mode	Precise mode
X-rite i1	15 min	30 min
JETI Specbos 1211	45 min	90 min

- (5) Enter Auto Calibration - Start Calibration, and the monitor will display information and probe position mark.

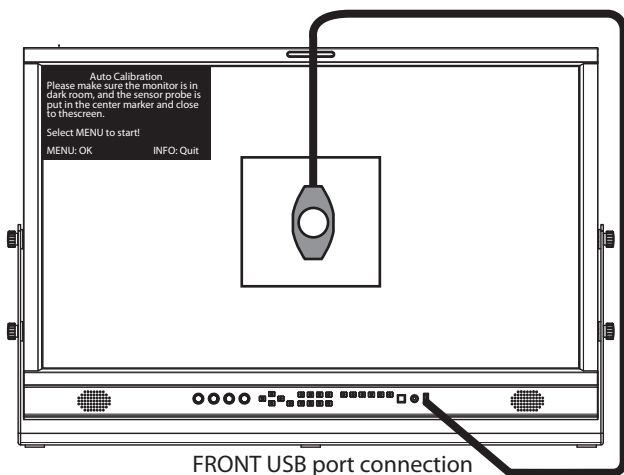

Auto Calibration  
Please make sure the monitor is in dark room, and the sensor probe is put in the center marker and close to the screen.

Select MENU to start!

MENU: OK

INFO: Quit

- (6) Select "YES", the auto calibration will start. The monitor will generate different color patterns one by one, and display the calibration progress in percentage.

- (7) After the calibration, the "Before Calibration" and "After Calibration" chart pops up in the center of the screen.

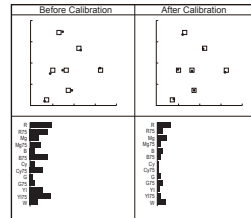

Auto Calibration  
Progress 37%  
Please wait...  
Select INFO to Cancel!  
INFO:Quit

- Press "INFO" to quit the calibration process at any time. The monitor will not be calibrated until process reaches 100%.

## \*11 Measure

The monitor has been calibrated in factory. And may need to be re-calibrated after a period of time.

Before re-calibrated, the measure function can check the current color to compare with the last time calibrated color, to decide if the monitor need to be re-calibrated.

Connector with the sensor probe and place the sensor probe onto the right position like calibration step.

Enter Auto Calibration - Measure.

The monitor will generate several colors and finish measure within 30 seconds. And display the result as:

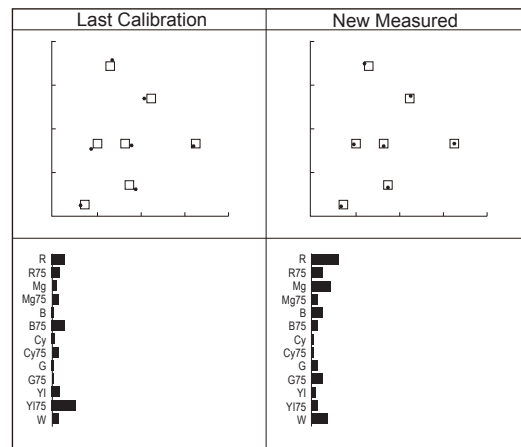

CIE and Delta E  
result of last calibration

CIE and Delta E  
result of new measured

- The color chart can be switched on/off at:  
Menu - Tool & Information - Color Checker - ON/OFF.

# Menu Configuration (cont.)

## Signal Scanning

Setting for picture scan, zoom, flip, etc.

Item	To do	Setting value
Scanning*1	Select a mode to fit video to LCD panel	Panel Fit, Pixel to Pixel, Native
Zoom Area Selection*2	Select an area to zoom-in	OFF, Top Left, Top, Top Right, Left, Center, Right, Bottom Left, Bottom, Bottom Right
Freeze Frame*3	Select a freeze frame mode	OFF, Top Half, Bottom Half, Full
Odd/Even Frame*4	Switch on odd or even lines display mode	OFF, Odd Mode, Even Mode
H/V Delay*5	Switch on/off the H/V delay mode	OFF, ON
Flip Mode*6	Switch on/off the up/down flip mode	OFF, ON
Low Latency Mode*7	Switch on/off the low latency mode	OFF, ON
Back	Return to previous menu	
Exit	Exit Main Menu	

### \*1 Scanning

Panel Fit: Stretch the video to fit the full screen.  
Native: Only displayed at 4096\*2160, black edges appear up and down the screen.

### \*2 Zoom Area Selection

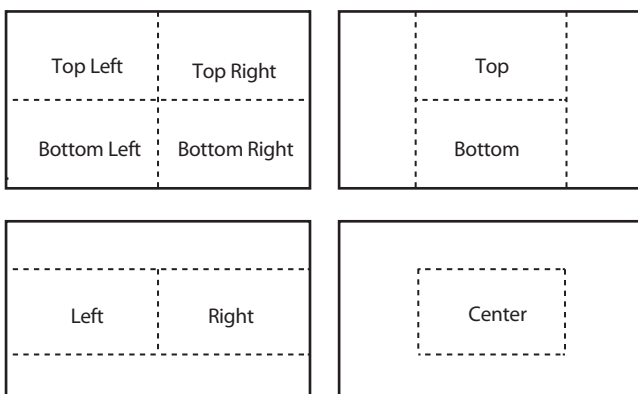

Zooms are not displayed at 4x3G、480I60、576I50、720P23.98、720P24、720P25、720P29.97、720P29.97、720P30、720P50、720P59.94 and 720P60

### \*3 Freeze Frame



Freeze Frame is not displayed at 4x3G.

### \*4 Odd/Even Frame

Odd/Even Frame is not displayed in all p formats.

### \*5 H/V Delay

H/V Delay is not displayed on HDMI channel.

### \*6 Flip Mode

Flip Modes are not displayed in 4x3G.

### \*7 Low Latency Mode

Low Latency Mode is a special image processing mode for lip-sync monitoring.  
For Progressive (p) formats, the monitor is low latency itself, whether Low Latency Mode is on or off.  
For Interlace (i) or Progressive Segmented Frame (psd) formats, turn on Low Latency Mode will get lower latency.

Video/Audio latency chart:

SDI formats	Low latency mode OFF	Low latency mode ON
4096x2160 60p	0.01 frame	0.01 frame
4096x2160 50p	0.1 frame	0.1 frame
4096x2160 30p	0.51 frame	0.51 frame
4096x2160 25p	0.6 frame	0.6 frame
4096x2160 24p	0.6 frame	0.6 frame
3840x2160 60p	0.01 frame	0.01 frame
3840x2160 50p	0.1 frame	0.1 frame
3840x2160 30p	0.51 frame	0.51 frame
3840x2160 25p	0.6 frame	0.6 frame
3840x2160 24p	0.6 frame	0.6 frame
2048x1080 60p	0.01 frame	0.01 frame
2048x1080 50p	0.1 frame	0.1 frame
2048x1080 30p	0.51 frame	0.51 frame
2048x1080 25p	0.6 frame	0.6 frame
2048x1080 24p	0.6 frame	0.6 frame
1080 60p	0.01 frame	0.01 frame
1080 50p	0.1 frame	0.1 frame
1080 30p	0.51 frame	0.51 frame
1080 25p	0.6 frame	0.6 frame
1080 24p	0.6 frame	0.6 frame
1080 24psf	2 frames	0.6 frame
1080 60i	2 frames	0.01 frame
1080 50i	2 frames	0.1 frame
720 60p	0.01 frame	0.01 frame
720 50p	0.1 frame	0.1 frame

# Menu Configuration (cont.)

## Tools & Information

Setting for Vector scope and Histogram patterns

Item	To do	Setting value
Focus Assist	Switch on focus assist mode and select color	OFF, Blue, Red
Zebra	Switch on zebra stripes for over exposed image	OFF, ON
False Color *1	Switch on false color mode	OFF, ON
Blue Only	Switch on blue only mode	OFF, ON
Marker	Marker	Switch on the marker display
	Marker Select	Select the marker ratio
	Horizontal	Set the horizontal axis scale
	Vertical	Set the vertical axis scale
	Safety Area	Set safety area percentage
	Fit Marker	Set safety area to fit marker ratio or not
	Center Marker	Switch on the center cross marker
	Marker Color	Select a color for marker
	Marker Outside	Marker outside color setting
	Back	Return to previous menu
Exit	Exit Main Menu	
Histogram	Histogram	Turn on/off the Histogram pattern
	Histogram Blending	Histogram background transparency selection
	Back	Return to previous menu
	Exit	Exit Main Menu
Waveform	Waveform	Switch on the Waveform pattern
	WFM Type	Waveform type select
	WFM Position	Waveform on screen display position setting
	WFM Blending	Waveform background transparency selection
	WFM Color	Waveform pattern color setting
	WFM Single Line *2	Switch on single line waveform mode
	WFM Line Count	Select a line for the single line waveform
	Back	Return to previous menu
Exit	Exit Main Menu	
Vector	Vector	Switch on vector scope pattern
	Vector Position	Vector scope on screen display position setting
	Vector Blending	Vector scope background transparency selection
	Vector Color	Vector scope pattern color setting
	Back	Return to previous menu
	Exit	Exit Main Menu
Time Code *3	Switch on Time code display	
Back	Return to previous menu	
Exit	Exit Main Menu	

### \*1: False Color

Under false color mode, there is a color chart on the bottom of screen for reference.

### \*2: WFM Single Line

Turn on the Waveform single line mode, the monitor will display waveform for only 1 line video.

Select a line at WFM Line Count by "▲" and "▼".

- Under WFM single line mode, out of Menu system, directly press "▲" and "▼" can select lines.

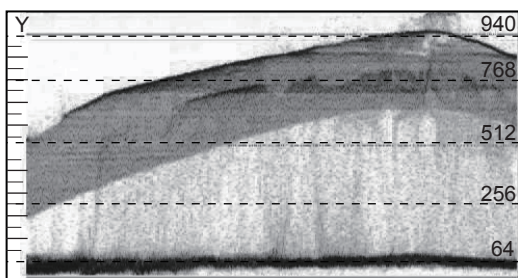

WFM Single Line: OFF

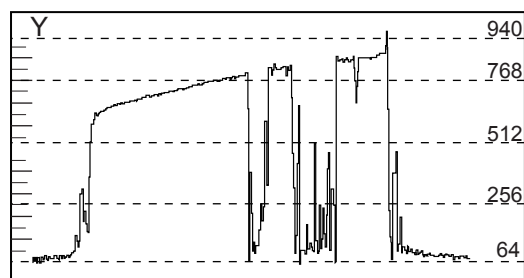

WFM Single Line: On

# Menu Configuration (cont.)

## \*3 Time code

Time Codes are not displayed on HDMI channel.

When the menu opens, the time code appears at the bottom of the screen, otherwise at the top.

## Audio

Setting for video/audio analysis functions

Item	To do	Setting value
Volume	Adjust volume	0~100
Left Channel	Select an audio channel to output left	Channel 1~Channel 16
Right Channel	Select an audio channel to output right	Channel 1~Channel 16
Audio Group*1	Select four audio channels to display	Group 1, Group 2, Group 3, Group 4
Audio Bar	Switch on the audio meter display	OFF, ON
Bar Position	Change on screen display position of the audio bar.	Bottom Right, Top Left Top Right, Bottom Left
Bar Blending	Adjust the audio bar pattern background transparency.	OFF, Low, High
Bar Type*2	Switch on the mark and alert info of audio meter pattern.	TYPE1, TYPE2 *4
Lissajous	Switch on the audio Lissajous pattern display	OFF, ON
Lissajous Position	Change on screen display position of the Lissajous pattern.	Top Left, Top Right, Bottom Left, Bottom Right,
Back	Return to previous menu	
Exit	Exit Main Menu	

## \*1: Audio Group

Switch on Four-screen Splitter, the audio bar only displays 4 audio channels. This menu can choose the 4 audio channels that needed display.

## \*2: Bar Type

The audio bar displays up to 16 channels audio level meters.

The TYPE1 displays audio meters only.

The TYPE2 displays audio dB mark, audio alert info, and left channel and right channel selection.

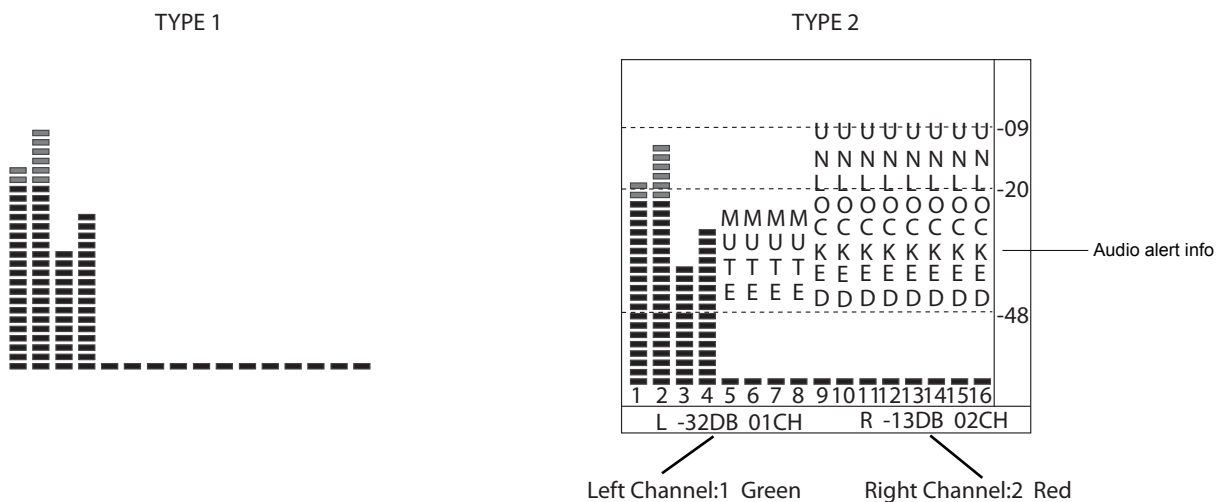



# Menu Configuration (cont.)

## External Control

Setting for TALLY, UMD, IP control to the monitor

Item	To do	Setting value
Tally Setting	Set on-screen tally display mode	OFF, ON, Blinking
Tally Position	Select the display position of on-screen tally	Top, Bottom
GPI *1	GPI Control	Enable GPI control
	1 Pin	Assign functions to the GPI terminals
	2 Pin	
	3 Pin	
	4 Pin	
	5 Pin	
	6 Pin	
	Back	Return to previous menu
Exit	Exit Main Menu	
UMD *2	Switch on the UMD display	OFF, ON
UMD Mode	Select the UMD source	Internal, External
UMD Position	Select the display position of UMD	Top, Bottom
UMD Size	Select UMD display size	Large, Small
UMD Color	Select UMD display color	White, Red, Green, Blue, Black, Gray
UMD Blending	Select UMD background transparency	OFF, Low, HIGH
Source ID	Edit internal UMD letters	A-Z, a-z, 0-9, Space, &()*+,-./:<>_
TSL Address	TSL UMD setting	1~126
TSL Baud Rate		115200
TSL Data Bits		8
TSL Parity		None
TSL Stop Bits		1
IP *3	Set monitor IP address for webserver remote control	192.168.001.200
Net Mask		255.255.255.000
Gateway		192.168.001.001
Port(1024~65535)		08080
Back		Return to previous menu
Exit	Exit Main Menu	

### \*1 GPI control

Connect GPI remote controller with "GPI" port of the monitor rear panel,  
Switch on the "GPI Control".  
Assign functions for GPI 1-6.  
Control the GPI 1-6 pin terminals to short-circuit with the GND pin terminal, to enable the assigned function, and disconnecting (opening) to disable the functions.

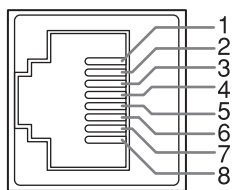

GPI

Pin No	Pin name
1	GPI 1
2	GPI 2
3	GPI 3
4	GPI 4
5	GPI 5
6	GPI 6
7	NC
8	GND

The GPI controlled TALLY signal will display both front TALLY light and on-screen TALLY:

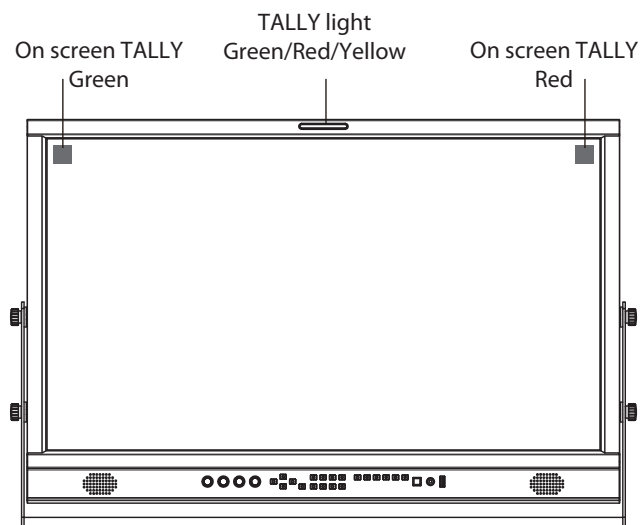

# Menu Configuration (cont.)

## \*2 UMD control

Select UMD mode to "External" will enable TSL UMD control. TallyMan system connection:

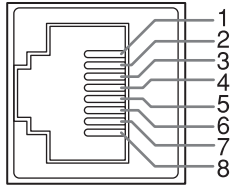

RS485 IN

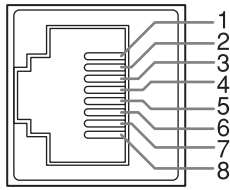

RS485 OUT

They are female terminals.

Pin No	IN terminal signal	OUT terminal signal
1	GND	GND
2	NC	NC
3	RXD-	RXD-
4	NC	NC
5	NC	NC
6	RXD+	RXD+
7	TXD-	TXD-
8	TXD+	TXD+

Serial connections:

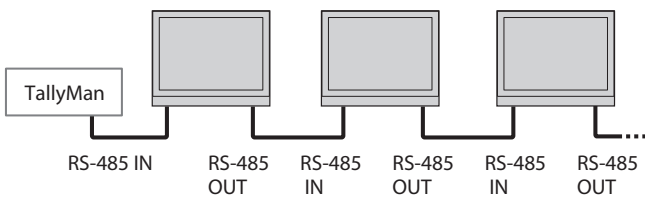

## \*3 Webserver IP Control

Connect the monitor ETHERNET port into LAN, and the monitor can be remote controlled by webpage.

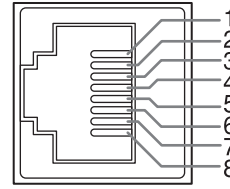

ETHERNET

Pin No	Pin name
1	TX+
2	TX-
3	RX+
4	
5	
6	RX-
7	
8	

Enter Menu- External Control - IP/Net Mask/Gateway/Port to set the monitor addresses.

Set the computer Ethernet IP address at the same LAN environment as the Monitor.

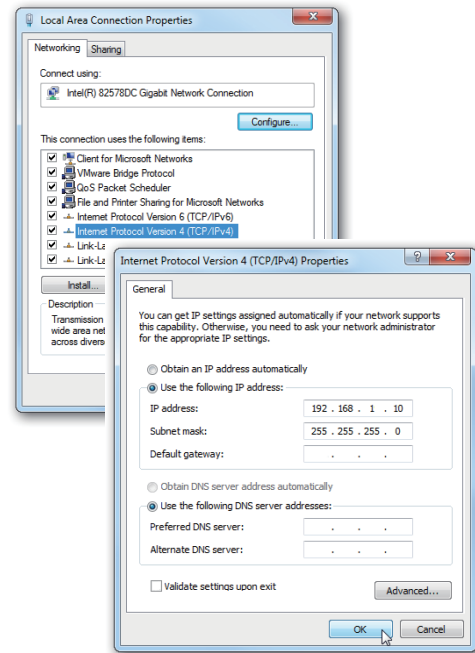

2) Launch any of a web browser on the computer, and enter URL: Monitor IP + port (for example 192.168.1.99:8080). The webserver control page will be displayed.

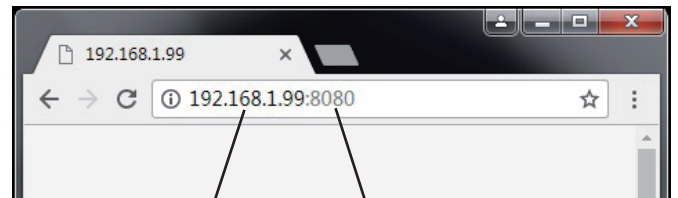

Monitor IP address      Monitor port address

- Use crossed wired cable for computer-monitor directly connection.
- Use straight-through wired cable for Router connection.
- Please seek help from your webmaster for any network connections.

# Menu Configuration (cont.)

Websvrer page control interface



DT-U series

**Status**

Input Source: Four-screen  
Input Format: 1920\*1080I59.94  
Loaded Profile: USER 1 !

Video Level Range: 64-940  
YUV Color Matrix: BT.709  
Volume: 29

Chroma: 2

Bright: 0

Contrast: 0

Freeze Frame: OFF

Odd/Even Frame: OFF

Low Latency: OFF

Gamma: 2.4

Color Temp: D65

Log Mode: OFF

Monitor IP: 192.168.1.200  
Net Mask: 255.255.255.0

Gateway: 192.168.1.1

Port: 8080

**Refresh Status**

**Settings** Network Update

**Input Source:** SDI1 SDI2 SDI3 SDI4 SQ 2-SI SFP HDMI

**Loaded Profile:** USER 1 !

**Function Key:** F1 F2 F3 F4 F5 F6

**Volume:** 0 29 100  **Set**

**Chroma:** -100 2 100  **Set**

**Brightness:** -100 0 100  **Set**

**Contrast:** -100 0 100  **Set**

**Frame:** Freeze Frame OFF TopHalf BottomHalf Full

Odd/Even Frame Odd Even OFF

Low Latency ON OFF

**Color:** VideoLevelRange 64-940 YUVColorMatrix Auto

Gamma 2.4 Color Temp D65

After changing settings, please click the refresh button to see the new status.

**Settings** Network Update

**Monitor IP:**

**Net Mask:**

**Gateway:**

**Port:**  **Set** 1024-65535

**Settings** Network Update

Current Version:

Notes:

1. Please make sure you have the update zip package on your PC.
2. Recommend to do Firmware updates only with AC power support.
3. Never shutdown the power during updating progress.

Please following these instructions:

Search a new update zip package on your PC:  未选择任何文件

Press 'submit' to transfer it to the monitor:

Now ready to install, press 'Update':

# Menu Configuration (cont.)

## System Setting

User profile saving, firmware update.

Item	To do	Setting value
Multiview *1	Switch on multiview	OFF,ON
Load Profile *2	Global	Select a user profile for all input sources
	SFP	Select a user profile for SFP input only
	SDI1	Select a user profile for SDI 1 input only
	SDI2	Select a user profile for SDI 2 input only
	SDI3	Select a user profile for SDI 3 input only
	SDI4	Select a user profile for SDI 4 input only
	4xSDI(SQ)	Select a user profile for Quad split 4x3G input only
	4xSDI(2-SI)	Select a user profile for 2SI interleave 4x3GSDI input only
	HDMI	Select a user profile for HDMI input only
	Back	Return to previous menu
Exit	Exit Main Menu	
Save Profile	Save all the current menu settings to User profile, support rename user profile when saving.	User 1-8
Key Brightness	Set front key board light brightness	OFF, LOW, HIGH
OSD TIME (Sec)	Select a time to quit menu if there's no operation	5-180
F1	Assign functions to the function keys F1 - F6 on the front key board	Time code, Color Temp,Flip mode, Freeze Frame, WFM Type, WFM Single Line, UMD, Marker, H/V Delay, Blue Only, Audio bar, Zebra, Vector, Low Latency Mode, Histogram, Odd/Even Frame, Lissajous, Focus Assist, False color, Multiview
F2		
F3		
F4		
F5		
F6		
Green Mode	Turn down or switch off the LCD backlight to save energy	Black Backlight, Gray Backlight
Idle Duration	Select a time to enter Green mode if there's no operation	30Sec, 1Hour, 2Hour, 4Hour, OFF
Key Lock *3	Select a key lock mode	OFF, Lock All, Lock Rotary Knobs, Lock Key Buttons
Closed Caption*4	Switch on closed caption	NO, YES
Firmware Update *5	Enter firmware update	NO, YES
System Reset	Reset all the monitor settings	NO, YES
Back	Return to previous menu	
Exit	Exit Main Menu	

### \*1 Multiview

Switch on Multiview, the monitor can display 4 different formats SDI signal, supported displaying 1080P/1080I/1080PsF/4K, as shown in the following figure:

4K (SDI 1 IN)	1080P (SDI2 IN)
1080PsF (SDI3 IN)	1080I (SDI4 IN)

When Multiview is selected

- 1、Video Lumina Range、YUV Color Matrix、Color Processing、Gamma and UMD of each channel can be set respectively.
- 2、Some menu functions are turned off or displayed in grey.

### \*2 Load Profile

Select "Global" to "User 1-8", to assign the user profile to all the input sources;  
Select "Global" to "OFF", the user profiles can be assigned to each input source individually.

# Menu Configuration (cont.)

## \*3 Key Lock

Select different keys to lock:

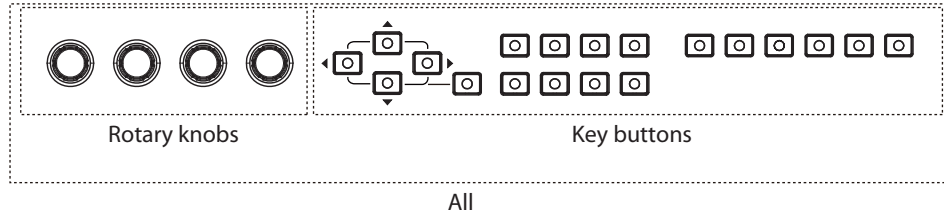

- The MENU button can be operated when key locked.
- Press the locked buttons or knobs, the screen will display:

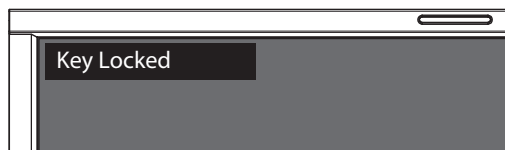

## \*4 Closed Caption

Only SDI signal system has closed caption menu items.

## \*5 Firmware Update

The monitor firmware can be updated by front USB port.

Update steps:

- (1) Download latest firmware file (DT-UXX Vxx YYMMDD.zip) to USB disk, root directory.
- (2) Switch on the monitor, and plug USB disk into front USB port.
- (3) Operate MENU- System Setting- Firmware Update, and the monitor will update automatically.
- (4) When updating succeed, switch the monitor off by front POWER button and switch on again.

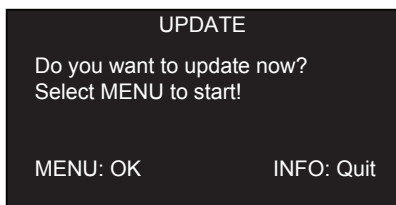

- Please copy only 1 firmware for 1 model monitor into USB root directory.
- Caution! DO NOT cut off power during firmware update.

# Specifications

## General

Model name	DT-U31	DT-U27HB	DT-U31PRO
Type	Multi format LCD monitor		
Screen size	31.5"	27"	31.1"
Aspect ratio	16:9		
Horizontal/vertical frequency (computer signal)	H: 61.93kHz – 92.9 kHz V: 50 Hz – 75 Hz	H: 61.93kHz – 92.9 kHz V: 50 Hz – 75 Hz	H: 64kHz – 83kHz V: 50 Hz – 75 Hz
* Some signals within this frequency range may not be displayed			
Compliant video signal format	☞ "Available signals" on page 24		
Format	12G SDI: SMPTE ST2080 6G SDI: 3840x2160 30/25/24p 3G SDI: SMPTE-425M-A/B HD SDI: BTA S-004C, SMPTE292M, SMPTE-425M-A/B, SMPTE-274M, SMPTE-RP211, SMPTE-296M SD SDI: SMPTE-125M, ITU-R BT.656 2K: SMPTE ST 2048-1: 2011 EMBEDDED AUDIO: SMPTE299M, SMPTE272M		
Audio output	Internal speaker: 1.25W+1.25W(8Ω)		
Operating conditions	Operating temperature: 0°C – 40°C (41°F – 95°F) Operating humidity: 20% – 80% (non-condensing) (Slightly variable depending on ambient conditions for installation.)		
Power requirements	AC 120 V / AC 220 – 240 V, 50 Hz/60 Hz; DC12 - 17V	AC 120 V / AC 220 – 240 V, 50 Hz/60 Hz	AC 120 V / AC 220 – 240 V, 50 Hz/60 Hz
Rated current	1A (AC 100V-240V) 8.5A (DC12-17V)	1.5A (AC 100V-240V)	1.5A (AC 100V-240V)
External dimensions (with the stand) (excluding protruding parts)	Width: 759.1 mm (29 7/8") Height: 529.3mm (20 13/16") Depth: 150 mm (5 7/8")	Width: 657.6 mm (25 7/8") Height: 472.3mm (18 9/16") Depth: 150 mm (5 7/8")	Width: 758.2mm (29 7/8") Height: 504mm (19 7/8") Depth: 150 mm (5 7/8")
External dimensions (without the stand) (excluding protruding parts)	Width: 759.1 mm (29 7/8") Height: 493.3mm (19 7/16") Depth: 94 mm (3 11/16")	Width: 657.6 mm (25 7/8") Height: 436.3mm (17 3/16") Depth: 94 mm (3 11/16")	Width: 758.2mm (29 7/8") Height: 468mm (18 7/16") Depth: 94 mm (3 11/16")
Weight(without the stand)	12.7 kg (28 lbs)	11.3 kg (24.9 lbs)	12.2 kg (26.9 lbs)
Weight(with the stand)	16.5 kg (36.4 lbs)	13.8kg (30.4 lbs)	15.5 kg (34.2 lbs)
Accessories	AC power cord x 1, Monitor U shape stand x 1		

## LCD panel

Model name	DT-U31	DT-U27HB	DT-U31PRO	
Effective screen size	Width	698.4 mm (27 1/2")	596.736mm (23 1/2")	697.958 mm (27 1/2")
	Height	392.85 mm (15 1/2")	335.664 mm (13 3/16")	368.064 mm (14 1/2")
	Diagonal	800.1 mm (31 1/2")	685.8 mm (27")	789.9 mm (31 1/8")
Number of pixels displayed	3840 x 2160		4096 x 2160	
Number of colors displayed	1.073G		1.073G	
Viewing angle (TYP.)	178° (H), 178° (V)		178° (H), 178° (V)	
Brightness (TYP.)	350 cd/m2		350 cd/m2	
Contrast ratio (TYP.)	3000:1		1500:1	

## Input/output terminals

Video	HDMI	HDMI connector x 2(IN and OUT)
	E. AUDIO 12G/6G/3G/HD/SD SDI	Digital signal input (compatible with EMBEDDED AUDIO signals): auto detection, 2 line, BNC connector x 2
	E. AUDIO 3G/HD/SD SDI	Digital signal output (compatible with EMBEDDED AUDIO signals): auto detection, 2 line, BNC connector x 2
Audio	AUDIO (MONITOR OUT)	Speaker: 1.25W+1.25W(8Ω) 3.5mm phone
External control	GPI (MAKE)	☞ "GPI control" on page 16.
	UMD (RS-485) IN&OUT	☞ "UMD control" on page 17.
	Ethernet IP (RJ-45)	☞ "Webserver IP control" on page 17&18.

# Specifications (cont.)

## Dimensions Unit: mm

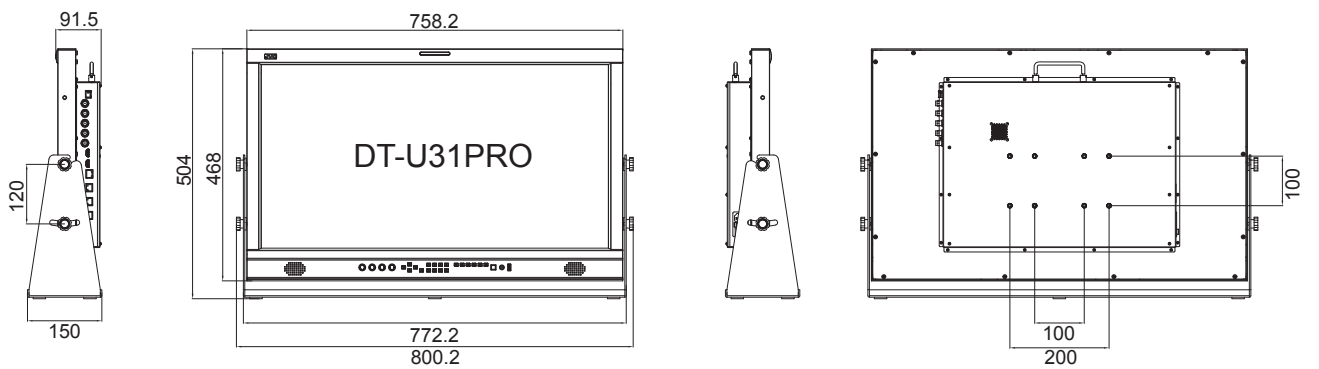
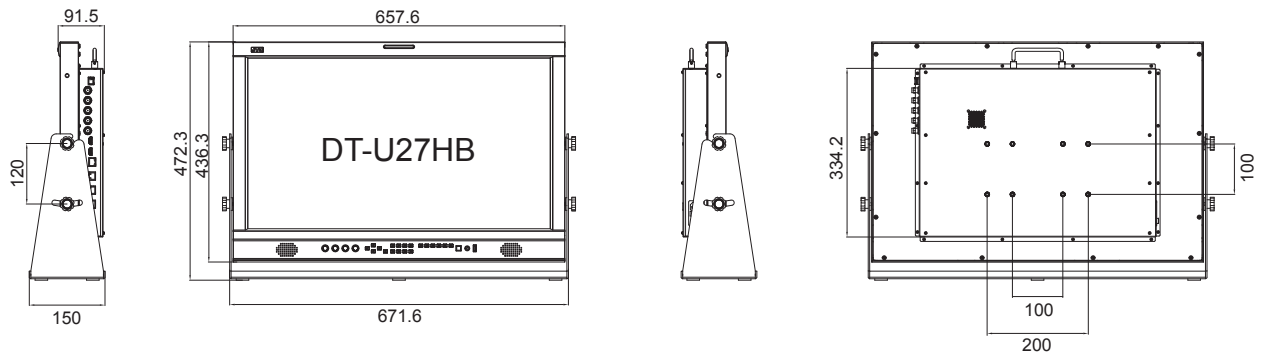
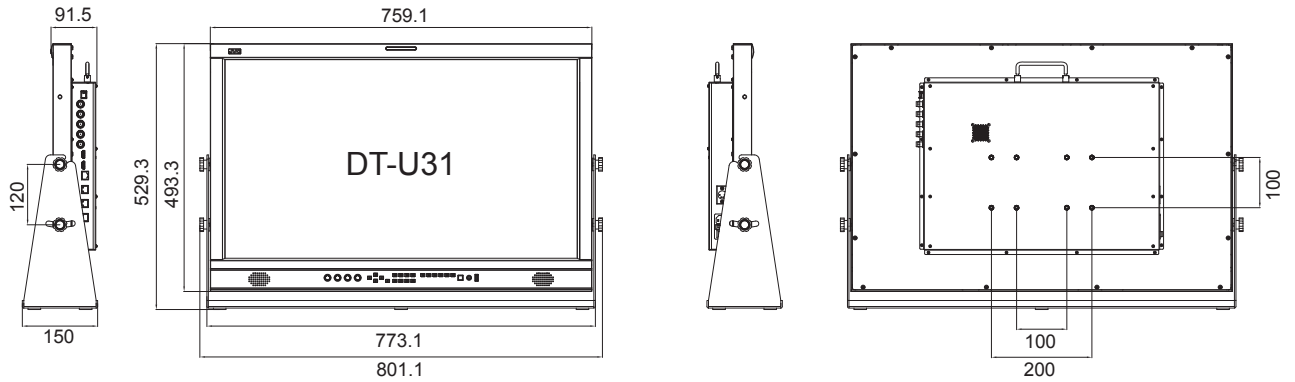

# Specifications (cont.)

## Available signals

The following signals are available for this monitor.

### Video signals

No.	Formats	Input terminal				Signal format shown in the Status Display as	
		SDI 1 & SFP	SDI 2/3/4	Quadlink SDI	HDMI	SDI & SFP	HDMI
1	720×480/60I	✓	✓	—	—	720*480I60	720*480I60
2	720×480/60P	—	—	—	✓	720*480P60	720*480P60
3	720×576/50I	✓	✓	—	—	720*576I50	720*576I50
4	720×576/50P	—	—	—	✓	720*576P50	720*576I50
5	1280×720/23.98P	✓	✓	—	✓	1280*720P23.98	1280*720P24
6	1280×720/24P	✓	✓	—	✓	1280*720P24	1280*720P24
7	1280×720/25P	✓	✓	—	✓	1280*720P25	1280*720P25
8	1280×720/29.97P	✓	✓	—	✓	1280*720P29.97	1280*720P30
9	1280×720/30P	✓	✓	—	✓	1280*720P30	1280*720P30
10	1280×720/50P	✓	✓	—	✓	1280*720P50	1280*720P50
11	1280×720/59.94P	✓	✓	—	✓	1280*720P59.94	1280*720P60
12	1280×720/60P	✓	✓	—	✓	1280*720P60	1280*720P60
13	1920×1080/50I	✓	✓	—	✓	1920*1080I50	1920*1080I50
14	1920×1080/59.94I	✓	✓	—	✓	1920*1080I59.94	1920*1080I60
15	1920×1080/60I	✓	✓	—	✓	1920*1080I60	1920*1080I60
16	1920×1080/23.98PSF	✓	✓	—	✓	1920*1080PSF23.98	1920*1080PSF24
17	1920×1080/24PSF	✓	✓	—	✓	1920*1080PSF24	1920*1080PSF24
18	1920×1080/23.98P	✓	✓	—	✓	1920*1080P23.98	1920*1080P24
19	1920×1080/24P	✓	✓	—	✓	1920*1080P24	1920*1080P24
20	1920×1080/25P	✓	✓	—	✓	1920*1080P25	1920*1080P25
21	1920×1080/29.97P	✓	✓	—	✓	1920*1080P29.97	1920*1080P30
22	1920×1080/30P	✓	✓	—	✓	1920*1080P30	1920*1080P30
23	1920×1080/48P	✓	✓	—	✓	1920*1080P48	1920*1080P48
24	1920×1080/50P	✓	✓	—	✓	1920*1080P50	1920*1080P50
25	1920×1080/59.94P	✓	✓	—	✓	1920*1080P59.94	1920*1080P60
26	1920×1080/60P	✓	✓	—	✓	1920*1080P60	1920*1080P60
27	2048×1080/23.98PSF	✓	✓	—	✓	2048*1080PSF23.98	2048*1080PSF24
28	2048×1080/24PSF	✓	✓	—	✓	2048*1080PSF24	2048*1080PSF24
29	2048×1080/25PSF	✓	✓	—	✓	2048*1080PSF25	2048*1080PSF25
30	2048×1080/29.97PSF	✓	✓	—	✓	2048*1080PSF29.97	2048*1080PSF30
31	2048×1080/30PSF	✓	✓	—	✓	2048*1080PSF30	2048*1080PSF30
32	2048×1080/23.98P	✓	✓	—	✓	2048*1080P23.98	2048*1080P24
33	2048×1080/24P	✓	✓	—	✓	2048*1080P24	2048*1080P24
34	2048×1080/25P	✓	✓	—	✓	2048*1080P25	2048*1080P25
35	2048×1080/29.97P	✓	✓	—	✓	2048*1080P29.97	2048*1080P30
36	2048×1080/30P	✓	✓	—	✓	2048*1080P30	2048*1080P30
37	2048×1080/47.94P	✓	✓	—	✓	2048*1080P47.94	2048*1080P50
38	2048×1080/48P	✓	✓	—	✓	2048*1080P48	2048*1080P48
39	2048×1080/50P	✓	✓	—	✓	2048*1080P50	2048*1080P50
40	2048×1080/59.94P	✓	✓	—	✓	2048*1080P59.94	2048*1080P60
41	2048×1080/60P	✓	✓	—	✓	2048*1080P60	2048*1080P60
42	3840×2160/23.98P	✓	—	✓	✓	3840*2160P23.98	3840*2160P24
43	3840×2160/24P	✓	—	✓	✓	3840*2160P24	3840*2160P24
44	3840×2160/25P	✓	—	✓	✓	3840*2160p25	3840*2160p25
45	3840×2160/29.97P	✓	—	✓	✓	3840*2160P29.97	3840*2160P30
46	3840×2160/30P	✓	—	✓	✓	3840*2160P30	3840*2160P30
47	3840×2160/47.94P	✓	—	✓	✓	3840*2160P47.94	3840*2160P50
48	3840×2160/48P	✓	—	✓	✓	3840*2160P48	3840*2160P48
49	3840×2160/50P	✓	—	✓	✓	3840*2160P50	3840*2160P50
50	3840×2160/59.94P	✓	—	✓	✓	3840*2160P59.94	3840*2160P60
51	3840×2160/60P	✓	—	✓	✓	3840*2160P60	3840*2160P60
52	4096×2160/23.98P	✓	—	✓	✓	4096*2160P23.98	4096*2160P24
53	4096×2160/24P	✓	—	✓	✓	4096*2160P24	4096*2160P24
54	4096×2160/25P	✓	—	✓	✓	4096*2160P25	4096*2160P25
55	4096×2160/29.97P	✓	—	✓	✓	4096*2160P29.97	4096*2160P30
56	4096×2160/30P	✓	—	✓	✓	4096*2160P30	4096*2160P30
57	4096×2160/47.94P	✓	—	✓	✓	4096*2160P47.94	4096*2160P48
58	4096×2160/48P	✓	—	✓	✓	4096*2160P48	4096*2160P48
59	4096×2160/50P	✓	—	✓	✓	4096*2160P50	4096*2160P50
60	4096×2160/59.94P	✓	—	✓	✓	4096*2160P59.94	4096*2160P60
61	4096×2160/60P	✓	—	✓	✓	4096*2160P60	4096*2160P60

\*3G supports level A/ level B; Support RGB444

✓: Acceptable  
—: Not acceptable





## Service Contacts:

**Importer (EU only)**

**JVCKENWOOD U.K. Limited**

12 Priestley Way, London NW2 7BA, UNITED KINGDOM

**Importeur (Nur EU)**

**JVCKENWOOD Deutschland GmbH**

Konrad-Adenauer-Allee 1-11, 61118 Bad Vilbel, DEUTSCHLAND

**Importatore (Solo EU)**

**JVCKENWOOD Italia S.p.A.**

Via G. Sirtori 7/9, 20129 Milano, ITALIA

**Importador (solo UE)**

JVCKENWOOD Europe, B.V. – Spain  
Carretera de Rubi, 88 Planta 1A  
08174 Sant Cugat del Valles (Barcelona)

**Importeur (Alleen EU)**

**JVCKENWOOD Belgium N.V.**

Leuvensesteenweg 248J, 1800 Vilvoorde, BELGIQUE

**Importeur (Alleen EU)**

**JVCKENWOOD Europe B.V.**

Amsterdamseweg 37, 1422 AC Uithoorn, NEDERLAND

---

**Manufacturer**

**JVCKENWOOD Corporation**

3-12, Moriya-cho, Kanagawa-ku, Yokohama-shi, Kanagawa  
221-0022, JAPAN



**HDMI**<sup>TM</sup>  
HIGH-DEFINITION MULTIMEDIA INTERFACE

The terms HDMI and HDMI High-Definition Multimedia Interface, and the HDMI Logo are trademarks or registered trademarks of HDMI Licensing Administrator, Inc. in the United States and other countries.

**JVC**