

User Manual

Camiflex

Model: FG-CAM-F4/U

Camera over fiber extender



FOUGEROLLE
Rue de la Longueraie
35520 MELESSE
FRANCE
Tel :+33 (0)2 99 66 08 17
Fax : +33 (0)2 99 66 08 24
commercial@fougerolle-fr.com
www.fougerolle-fr.com

Version: 1.27
Date: 04/07/2016
Pages : 28



Table of contents

1 INTRODUCTION.....	4
1.1 CAUTION – SAFETY INSTRUCTIONS.....	4
1.2 SERVICES INFORMATION AND CONTACT.....	5
1.3 WASTE ELECTRICAL & ELECTRONIC EQUIPMENT (WEEE).....	5
1.4 RESTRICTION OF HAZARDOUS SUBSTANCES (RoHS).....	5
1.5 GUARANTIES.....	5
1.6 EMC AND SAFETY.....	6
1.7 BASE UNIT – HEAD UNIT.....	11
1.8 CAMI-VL ADAPTER.....	12
2 INSTALLATION.....	13
2.1 RACKMOUNT - BASE UNIT.....	13
2.2 HEAD UNIT & BASE UNIT FACE PLATE CONNEXION.....	14
2.3 HEAD UNIT SHOOTING POSITION.....	15
2.3.1 FIBER ROCKING SYSTEM.....	15
2.3.2 TALLY.....	15
2.4 CAMI-VL MOUNTING.....	16
3 OPERATION.....	17
3.1 POWER UP.....	17
3.2 DC IN.....	17
3.3 DC OUT.....	17
3.4 HEADSET: AUDIO SETTINGS – HEAD UNIT.....	18
3.5 AUDIO/HEADSET.....	19
3.6 INTERCOM.....	19
3.7 GENLOCK.....	20
3.8 SDI.....	20
3.9 REMOTE – RS232/RS422 (REMOTE 1).....	20
3.10 REMOTE – ETHERNET/USB (REMOTE 2).....	20
3.11 REMOTE – RS-232 (TTL REMOTE 3).....	20
3.12 REMOTE – LANC (REMOTE 4).....	20
4 PINOUT CONNECTORS.....	21
4.1 BASE UNIT – PINOUT CONNECTORS.....	21
4.1.1 BASE UNIT – REMOTE 1 – SERIAL CONNECTION.....	21
4.1.2 BASE UNIT – REMOTE 2 – ETHERNET (USB ON HEADUNIT).....	21



4.1.3 BASE UNIT – REMOTE 3 – SERIAL CONNECTION.....21

4.1.4 BASE UNIT – REMOTE 4 – LANC – SERIAL CONNECTION.....22

4.1.5 BASE UNIT – TALLY CONNECTION.....22

4.1.6 BASE UNIT – INTERCOM IN CONNECTION.....23

4.1.7 BASE UNIT – INTERCOM OUT CONNECTION.....23

4.1.8 BASE UNIT – HEADSET IN/OUT CONNECTION.....23

4.2 HEAD UNIT – PINOUT CONNECTORS.....24

4.2.1 HEAD UNIT – REMOTE/USB/LANC CONNECTIONS.....24

4.2.2 HEAD UNIT – INTERCOM IN/OUT CONNECTION.....25

4.2.3 HEAD UNIT – HEADSET IN/OUT CONNECTION.....25

4.2.4 HEAD UNIT – DC IN CONNECTION.....26

4.2.5 HEAD UNIT – DC OUT FOR CAMERA CONNECTION.....26

4.2.6 HEAD UNIT – EXTERNAL TALLY CONNECTION IN FRONT OF HEAD UNIT.....26

5 TECHNICAL SPECIFICATIONS.....27

5.1 POWER.....27

5.2 VIDEO INPUT AND OUTPUT.....27

5.3 VIDEO SIGNALING.....28

5.4 AUDIO/REMOTE.....28

1 INTRODUCTION

1.1 Caution – safety instructions

Please, read these instructions and heed all warnings.

- Do not use this apparatus near water.
- Do not install near any heat sources such as radiators, heat registers, stoves, or other apparatus (including amplifiers) that produce heat.
- For a full warranty, only use attachments/accessories specified by the manufacturer.
- Refer all servicing to qualified service personnel. Servicing is required when the apparatus has been damaged in any way, such as power-supply cord or plug is damaged, liquid has been spilled or objects have fallen into the apparatus, the apparatus has been exposed to rain or moisture, does not operate normally, or has been dropped.
- To reduce the risk of fire or electric shock, do not expose this product to rain or moisture.
- This device has to be installed by qualified personnel who knows the usual safety procedures and also follows the recommendations listed in this manual.
- The Base Unit chassis **MUST** be connected to a power supply with a proper grounding. This power connector (IEC 320) is the main connector for the network disconnection and must be easily accessible.
- Both Base Unit and Head Unit must be connected together thanks to hybrid fiber. Connection Base Unit or Head Unit to another equipment can cause failure and such use may cancel the guarantee.
- The mechanical ground of the equipment must be grounded. It is necessary to use an AC cord with Earth as the one supplied. If you choose to use another power cord, make sure it is appropriate.

100-240V ~ 50/60Hz 1A max
--

- Real consumption is depending on the power camera need : Lowest consumption value is around 0.3A
- Do not open the equipment when power supply is connected, otherwise there is a risk of electric shock and death.

Camera does not allow to be powered off by unplugging the DC IN but must be powered down thanks to camera switch off first.

Turning off the equipment is done with the front panel button.

FOUGEROLLE will not be responsible of any accident to a person or any damage to the equipment after use of the product without following these safety recommendations. Such use may cancel the guarantee.

In accordance with current standards, this unit is equipped with a unipolar protection by fuse.

F4AH 5x20 IEC 127

This means that a voltage is always present in the equipment when the power cord is connected to AC power. Do not remove the cover of the equipment without unplug the power cord.

1.2 Services information and Contact

For any question or support use the following contact:

FOUGEROLLE
Rue de la Longueraie
35520 MELESSE
FRANCE
Tel :+33 (0)2 99 66 08 17
Fax : +33 (0)2 99 66 08 24
commercial@fougerolle-fr.com
www.fougerolle-fr.com

1.3 Waste Electrical & Electronic Equipment (WEEE)



This symbol indicate that this product should not be disposed of with household waste, such as specify the WEEE European Directive (2012/19/EU) and the laws in your country.

This product must be entrusted to a designated collection point, for example, every time you buy a new similar product or to a collection point for agree recycling the electrical equipment or electronic (EEE). Inappropriate treatment treating this type of waste is likely to have impacts on environment and human health due to the presence of potentially hazardous substances generally associated with electrical or electronic equipment. Your cooperation to the correct disposal of this product will increase the efficient use of natural resources.

For further information about recycling this product, please contact your local services, your ECO-organization or the local authorities.

1.4 Restriction of Hazardous Substances (RoHS)

This product is compliant with directive 2012/19/UE, restricts the use of the following six substances:

- Lead (Pb)
- Mercury (Hg)
- Cadmium (Cd)
- Hexavalent chromium (Cr6)
- Polybrominated biphenyls (PBB)
- Polybrominated diphenyl ether (PBDE)

1.5 Guaranties

A product is faulty if it does not comply with the given description in this manual.

Duration of the guaranties is 3 years for this product against all hidden defects.

The warranty does not include the return shipping costs, degradations of any kind, consequences due to wrong uses of the product against the recommendations found in this manual and cable made by the customer.

1.6 EMC and Safety

This product meets all relevant CE:

EMC TESTS REPORT according to the standard(s):

- EN 55032: 2012
- EN 55103-2: 2009
- EN 61000-3-2: 2014
- EN 61000-3-3: 2013

Safety according to the standard(s):

- IEC 60065:2001 (Seventh Edition) + A1:2005 + A2:2010



AC N° R053-15-101503-A Ed.0

ATTESTATION DE CONFORMITE

ATTESTATION OF CONFORMITY

Suite aux essais effectués dans ses laboratoires, EMITECH atteste que l'équipement référencé ci-dessous est conforme à la (aux) norme(s) :

Further to the tests performed in its laboratories, EMITECH attests that the equipment specified below complies with the standard(s):

EN 55032 : 2012
EN 55103-2 : 2009
EN 61000-3-2: 2014
EN 61000-3-3: 2013

Au titre de la directive / In application to the directive : 2004/108/CE

Comme l'atteste le rapport d'essai

As related in the test report : R053-15-101503-A

Produit / Product :	Camera Over Hybrid Fiber
Marque de fabrique / Trade mark :	FOUGEROLLE
Type / Type:	ProFlex + CamiFlex
Nom du demandeur / Applicant's name:	FOUGEROLLE
Adresse / Address:	Rue de la Longeraie ZA des Landelles 35520 MELESSE

Adresse du fabricant si différent du demandeur
Manufacturer's address if different from the applicant's one

Modification(s) de l'équipement durant les essais CEM :
Modification(s) of the equipment during the EMC tests:

Non / Not required (voir rapport d'essais / see the tests report)

Cette attestation résulte d'essais effectués sur un exemplaire du produit, il n'implique pas une appréciation de l'ensemble de la fabrication des produits de série.
This attestation proceeds from the tests performed on one sample, it does not implicate a valuation of all the manufactured products.

Date : 29/07/2015



Signature :



Test Report issued under the responsibility of EMITECH

TEST REPORT IEC 60065 Audio, video and similar electronic apparatus - Safety requirements	
Report Number.....	RS053-15-101503-2/A Ed. 0
Date of issue.....	14 December 2015
Total number of pages.....	73
Applicant's name.....	FOUGEROLLE
Address.....	Rue de la longueraie – ZA des Landelles – 35520 MELESSE (France)
Test specification:	
Standard.....	IEC 60065:2001 (Seventh Edition) + A1:2005 + A2:2010
Test procedure.....	CE marking
Non-standard test method.....	N/A
Test Report Form No.	IEC60065K
Test Report Form(s) Originator.....	Intertek Semko AB
Master TRF.....	Dated 2010-10
Copyright © 2010 Worldwide System for Conformity Testing and Certification of Electrotechnical Equipment and Components (IECEE), Geneva, Switzerland. All rights reserved. This publication may be reproduced in whole or in part for non-commercial purposes as long as the IECEE is acknowledged as copyright owner and source of the material. IECEE takes no responsibility for and will not assume liability for damages resulting from the reader's interpretation of the reproduced material due to its placement and context. If this Test Report Form is used by non-IECEE members, the IECEE/IEC logo and the reference to the CB Scheme procedure shall be removed. This report is not valid as a CB Test Report unless signed by an approved CB Testing Laboratory and appended to a CB Test Certificate issued by an NCB in accordance with IECEE 02.	
Test item description.....	Camera over Hybrid fiber
Trade Mark.....	FOUGEROLLE
Manufacturer.....	FOUGEROLLE
Model/Type reference.....	CamiFlex
Ratings.....	18-48 Vdc (supplied by ProFlex) or 8-24 Vdc (with external supply not provided).





Testing procedure and testing location:		
<input checked="" type="checkbox"/>	Testing Laboratory:	EMITECH RENNES
Testing location/ address.....:		2 allée du chêne vert – 35 650 LE RHEU
Tested by (name + signature)		L.LAGARDE 
Approved by (name + signature)		D. MACAIGNE 
<input type="checkbox"/>	Associated CB Laboratory:	
Testing location/ address.....:		
Tested by (name + signature).....:		
Approved by (name + signature)		
<input type="checkbox"/>	Testing procedure: TMP	
Testing location/ address.....:		
Tested by (name + signature).....:		
Approved by (name + signature)		
<input type="checkbox"/>	Testing procedure: WMT	
Testing location/ address.....:		
Tested by (name + signature).....:		
Witnessed by (name + signature).....:		
Approved by (name + signature)		
<input type="checkbox"/>	Testing procedure: SMT	
Testing location/ address.....:		
Tested by (name + signature).....:		
Approved by (name + signature)		
Supervised by (name + signature).....:		
<input type="checkbox"/>	Testing procedure: RMT	
Testing location/ address.....:		
Tested by (name + signature).....:		
Approved by (name + signature)		
Supervised by (name + signature).....:		

Test Report issued under the responsibility of EMITECH

TEST REPORT IEC 60065 Audio, video and similar electronic apparatus - Safety requirements	
Report Number.....	RS053-15-101503-1/A Ed. 0
Date of issue.....	14 December 2015
Total number of pages.....	89
Applicant's name.....	FOUGEROLLE
Address.....	Rue de la longueraie – ZA des Landelles – 35520 MELESSE (France)
Test specification:	
Standard.....	IEC 60065:2001 (Seventh Edition) + A1:2005 + A2:2010
Test procedure.....	CE marking
Non-standard test method.....	N/A
Test Report Form No.	IEC60065K
Test Report Form(s) Originator.....	Intertek Semko AB
Master TRF.....	Dated 2010-10
<p>Copyright © 2010 Worldwide System for Conformity Testing and Certification of Electrotechnical Equipment and Components (IECEE), Geneva, Switzerland. All rights reserved.</p> <p>This publication may be reproduced in whole or in part for non-commercial purposes as long as the IECEE is acknowledged as copyright owner and source of the material. IECEE takes no responsibility for and will not assume liability for damages resulting from the reader's interpretation of the reproduced material due to its placement and context.</p> <p>If this Test Report Form is used by non-IECEE members, the IECEE/IEC logo and the reference to the CB Scheme procedure shall be removed.</p> <p>This report is not valid as a CB Test Report unless signed by an approved CB Testing Laboratory and appended to a CB Test Certificate issued by an NCB in accordance with IECEE 02.</p>	
Test item description.....	Camera over Hybrid fiber
Trade Mark.....	FOUGEROLLE
Manufacturer.....	FOUGEROLLE
Model/Type reference.....	ProFlex
Ratings.....	100-240 Vac, 50/60 Hz, 1A max.



Testing procedure and testing location:		
<input checked="" type="checkbox"/>	Testing Laboratory:	EMITECH RENNES
Testing location/ address		2 allée du chêne vert – 35 650 LE RHEU
Tested by (name + signature)		L.LAGARDE 
Approved by (name + signature)		D. MACAIGNE 
<input type="checkbox"/>	Associated CB Laboratory:	
Testing location/ address		
Tested by (name + signature)		
Approved by (name + signature)		
<input type="checkbox"/>	Testing procedure: TMP	
Testing location/ address		
Tested by (name + signature)		
Approved by (name + signature)		
<input type="checkbox"/>	Testing procedure: WMT	
Testing location/ address		
Tested by (name + signature)		
Witnessed by (name + signature)		
Approved by (name + signature)		
<input type="checkbox"/>	Testing procedure: SMT	
Testing location/ address		
Tested by (name + signature)		
Approved by (name + signature)		
Supervised by (name + signature)		
<input type="checkbox"/>	Testing procedure: RMT	
Testing location/ address		
Tested by (name + signature)		
Approved by (name + signature)		
Supervised by (name + signature)		

1.7 Base Unit – Head Unit

The Base Unit-Head Unit equipment can extend your camera over single mode hybrid fiber up to 200m (for higher distances, please contact us.)

The Head Unit can be mounted either under the camera, between the tripod and the camera, or behind the camera, between the camera and its battery by using the VLock.

Compatible with main hand and shoulder cameras. The product support multiple data communication (TTL Serie, RS232, RS422, LANC). The Head Unit is transparent to the communication protocols of the main camera manufacturers.

Features:

- 1 x 3G/HD SDI from head to base unit
- 1 x 3G/HD SDI from base to head unit
- 1 x Genlock from base to head unit
- 2 x Tally (Preview / On Air) integrated on the Head Unit front, plus external Tally output.
- 1 x RS-232 / RS-422 configurable + Remote Power : remote 1
- 1 x USB/Ethernet : remote 2
- 1 x RS-232 (TTL remote 3) + Remote Power
- 1 x LANC (remote 4) + Remote Power
- 1 x DC OUT 12 / 13.2V 40W to power the camera (for more power, contact us)
- 1 x Single mode hybrid fiber up to 200m → 1 x Fischer Connectors Single mode hybrid Optical Fiber link
- 1 x Intercom link
- 1 x Microphone/headphone, configurable headset levels thanks to push button on Head Unit rear
- 1 x DC IN from +8V to +24V : allows to use Tactical Fiber up to 10Km of distances...

Warning: The Base Unit provide power to Remotes on the RS connectors.

Warning : be careful in case of connection directly to a computer (See connector PINOUT for details)



1.8 Cami-VL adapter

The Cami-VL adapter can be used to place the Head Unit between the camera and its battery.



Several way to use this option:

- If you use Tactical Optical Fiber (or big length of hybrid optical fiber), the power is not handle by the fiber cable any more. In this case, the battery is needed to power the Camera by using the Cami-VL adapter (see picture below). The Head Unit has to be powered thanks to an external cable that connect the Head Unit DC IN to the DTAP DC output on the Cami_VL.
- If you have a hybrid fiber, the battery is not needed and in this case, the Head Unit powers the camera by using an external cable connected between the Head Unit DC OUT and the external DC input of the Camera.



See installation instructions in Section 2.4

2 INSTALLATION

2.1 Rackmount - Base Unit

The equipment is designed to be installed in a standard 19" rack or any other support.

The equipment should be placed away from wet projections, with an ambient temperature between +5°C and +40°C.

The mounting of the equipment in the rack should be such that a hazardous situation may not be completed due to an abnormal mechanical load. Account must be taken for the connection of the equipment to the supply and the effect of possible overload protection against overcurrent and power cables. A study of the characteristics of the equipment must be made.

It is necessary to check the reliability of the grounding of the equipment especially for shunt connection.

Special extended temperature range products can be produced on customer request.

The boards video connections and power supply are done from the rear panel.

The video cables shall not weigh too heavily on the connectors.

The earth connection (bolt with nut) must be connected to the earth of rack.

2.2 Head Unit & Base Unit face plate connexion

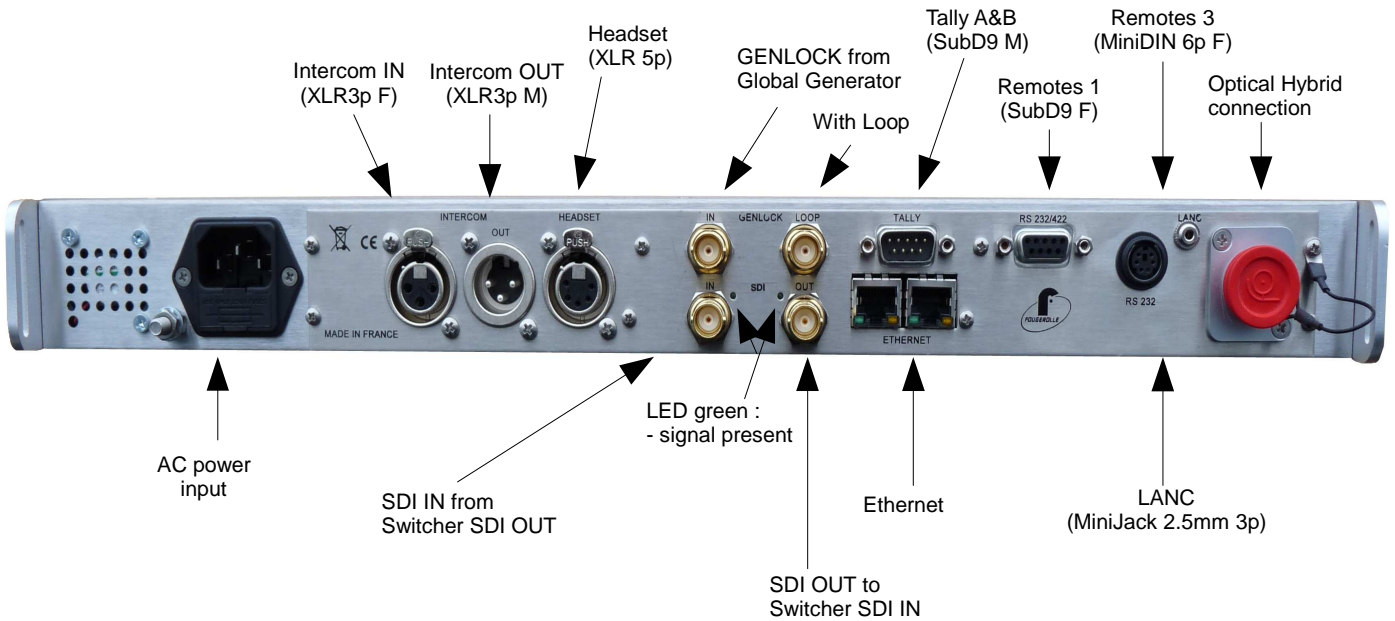
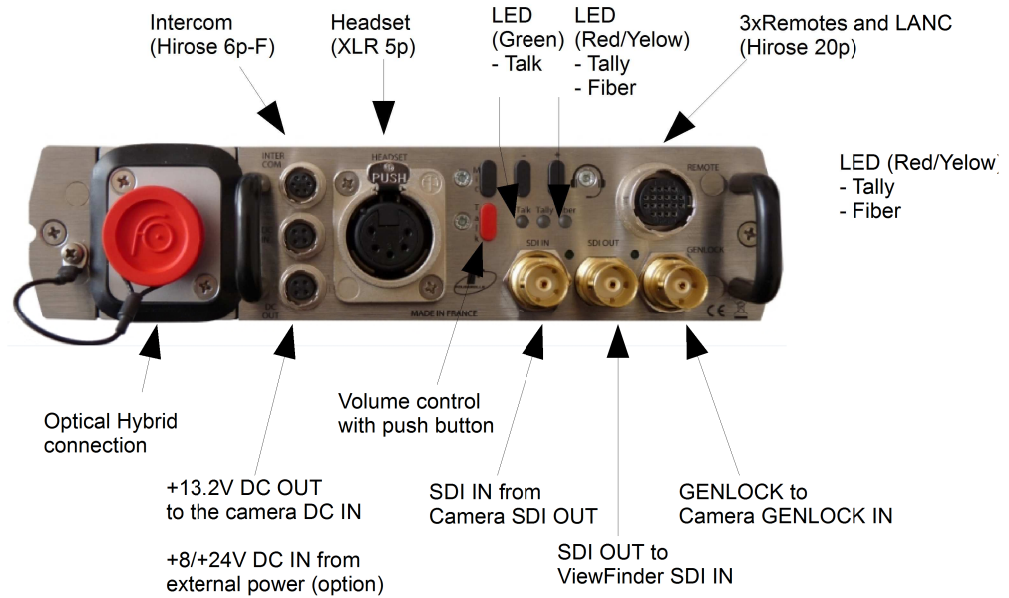

2.3 Head Unit shooting position

When Head Unit is located under the camera, the following items can be use.

2.3.1 Fiber rocking system

The optical connector can be pull out of the Head Unit in order to release the connector and thus guide the fiber down to about 45°.

- To use the system, you need to plug the fiber on Head Unit, then pull gently the connector toward you to tilt it down.
- To restore the system in its place, just push it in the Head Unit.

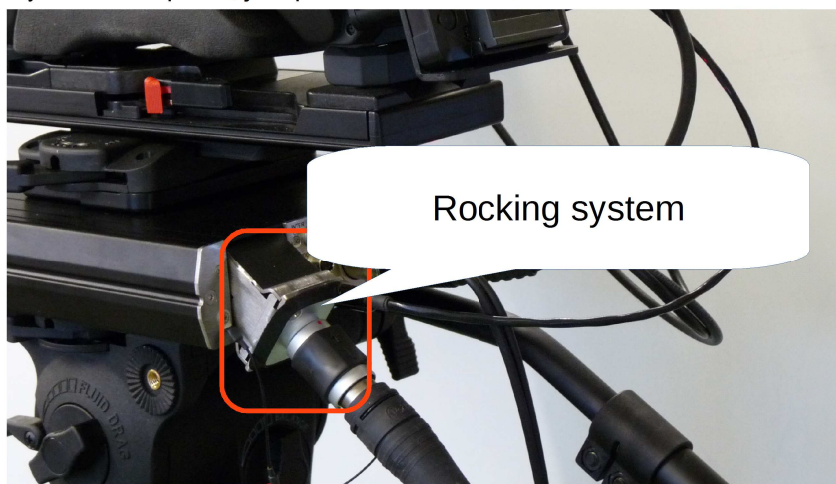

2.3.2 Tally

Tally I

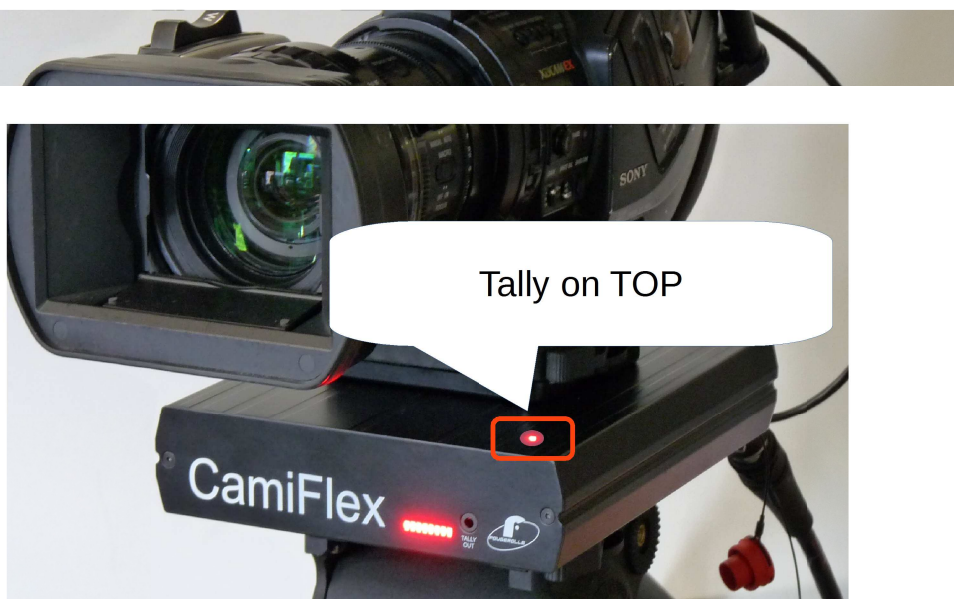

2.4 Cami-VL mounting

Insert the Head Unit inside the Cami-VL adapter:



Use the 4 screws:

Be careful, those screws are countersunk head **M3x10**. Other screw **MUST NOT** be used.



3 OPERATION

3.1 Power Up

Camera should be switch ON after Base Unit and OFF before. During the product power up, LEDs (Tally and Fiber) are blinking in orange, indicating that the product is booting up. This can take a few seconds.

During boot, the LED fiber is lighted in yellow (2 seconds), then switch off if the Fiber has no problem. Blinking Red means a failure on connection between Base Unit and Head Unit.



3.2 DC IN

Head Unit can be powered by 2 ways:

a) **with Hybrid Fiber (default mode)**: The power on Hybrid Fiber (48V) is internally converted by Head Unit for internal need and also to provide 13.2V DC OUT (see next section).

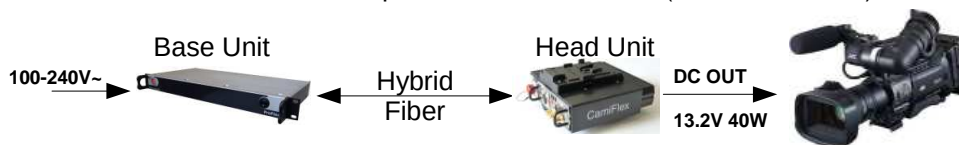

In such case, DC IN can be used for Head Unit redundancy in that mode.

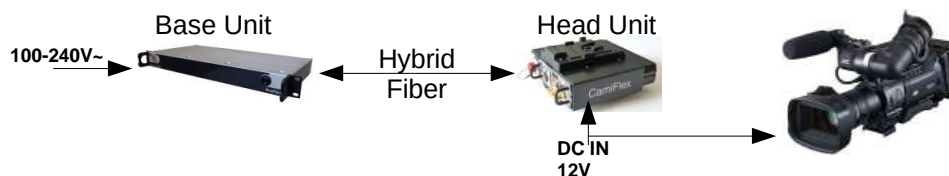

b) **without Hybrid Fiber (Tactical Fiber)**: Head Unit is powered by DC IN connector (From +8V to +24V IN). In such case DC OUT can not be used.

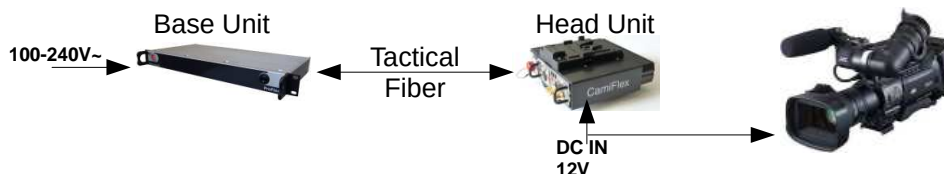

3.3 DC OUT

The Head Unit provide DC OUT in order to power the Camera (available only with Hybrid Fiber)
The maximum power consumption is: 40W (13.2V)

3.4 Headset: Audio settings – Head Unit

Several audio settings are available:

- push on "+" or "-" to adjust the headphone volume.
- push on "MIC" and then "+" or "-" to adjust the microphone volume.
- The Talk function: The LED "Talk" lights up when the microphone is enable with 2 modes:
 - Mode 1: Push "Talk" and holding the button to set the microphone, (PushToTalk) Release the button to disable the microphone.
 - Mode 2: Push "Talk" without holding the button to enable the microphone, (ON/OFF) Push "Talk" without holding the button to disable the microphone.



Mode change is possible by pushing simultaneous on buttons "MIC" and "Talk".

If needed, recall default settings by pressing simultaneous on buttons "Talk", "-" and "+" during 5 seconds (LED flashing) and then remain still to indicate that the return to factory settings is done.

The factory settings are: Mode1 (PushToTalk) with medium audio level.

Settings are saved automatically 10 seconds after each change, and are recalled after each new boot.

XLR 5p-F is used to connect Headset to the Head Unit. Dynamic microphone is needed.

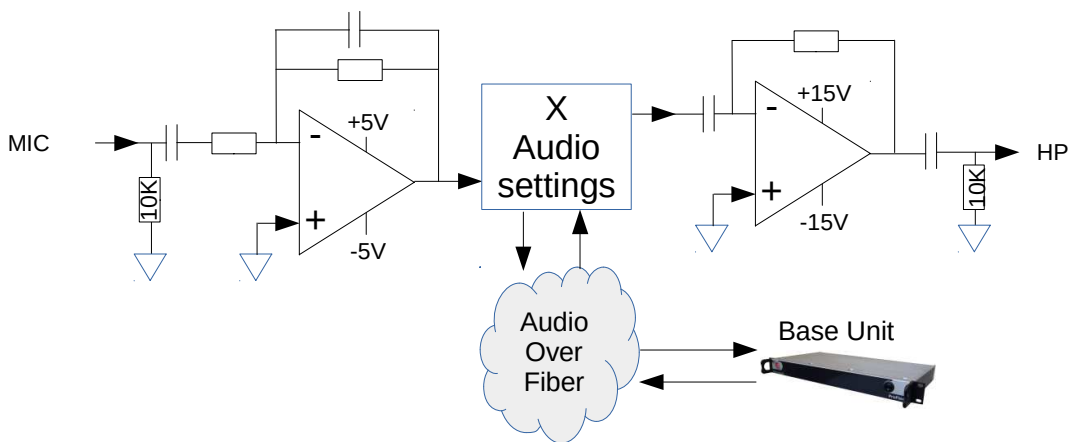

3.5 Audio/Headset

Analog balanced audio is transmit over fiber

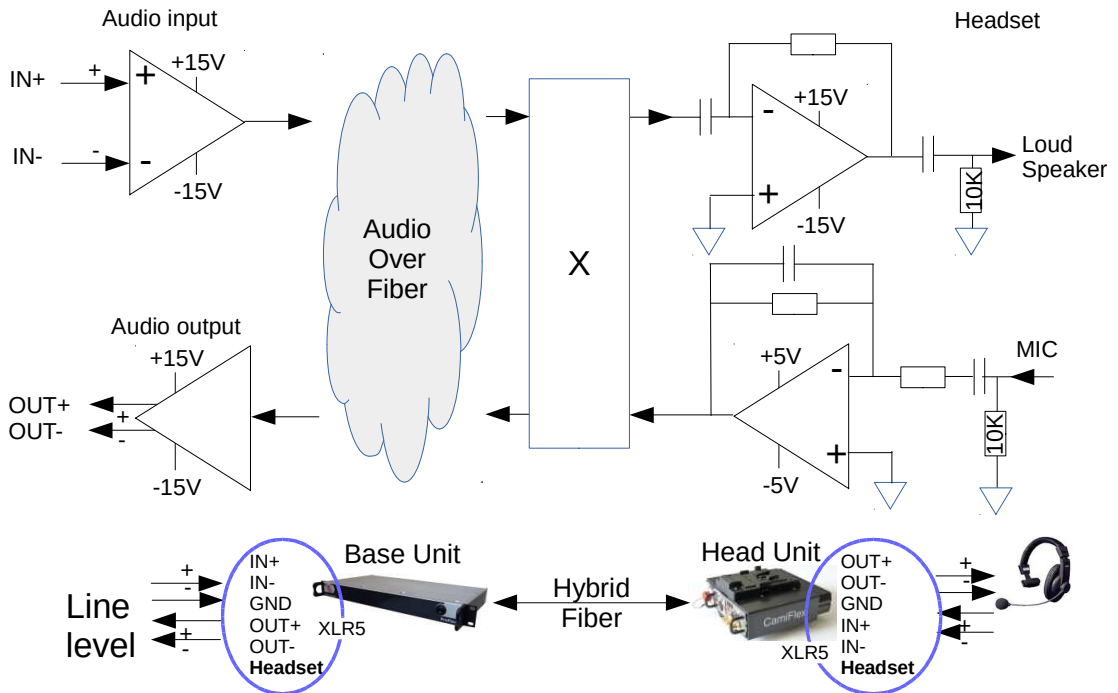

3.6 Intercom

4 wires intercom can be used:

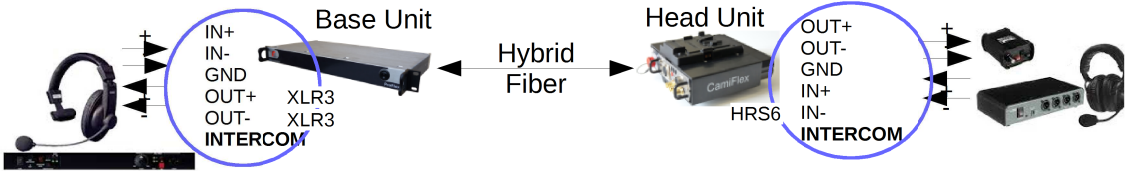

If needed, this intercom connection can support Time Code transmission

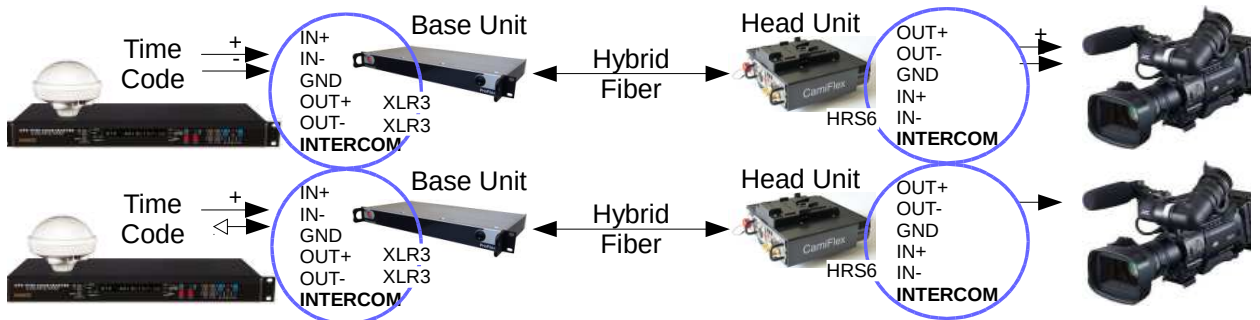

2 wires intercoms are not supported.

Connect such 2 wires intercoms may cause damages to the system.

3.7 Genlock

Genlock is CVBS and support PAL/NTSC video stream

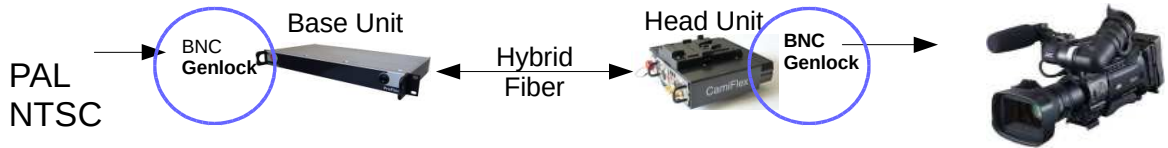

3.8 SDI

SD/HD/3G SDI can be used in both direction.

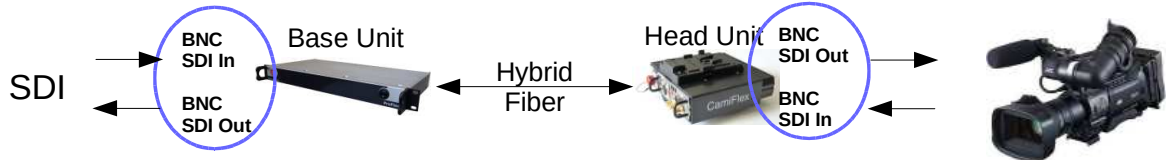

3.9 Remote – RS232/RS422 (remote 1)

Serial communication (any rate up-to 900Kbps) is available thought the system:

A specific cable must be used on Head Unit side and power is available to power the remote on Base Unit side.

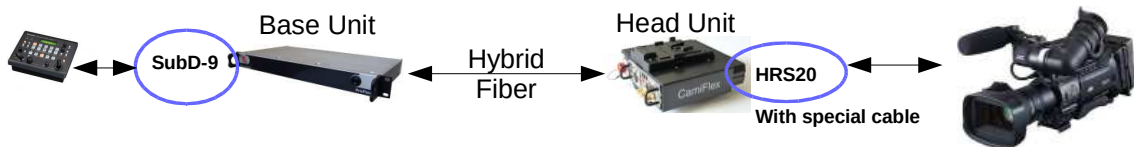

3.10 Remote – Ethernet/USB (remote 2)

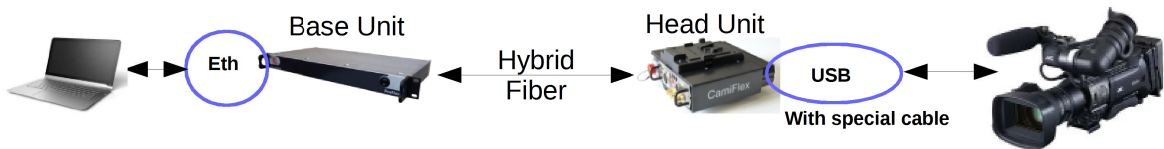

3.11 Remote – RS-232 (TTL Remote 3)

RS-232 communication (TTL level, any rate up-to 900Kbps) is available thought the system:

A specific cable must be used on Head Unit side and power is available to power the remote on Base Unit side.

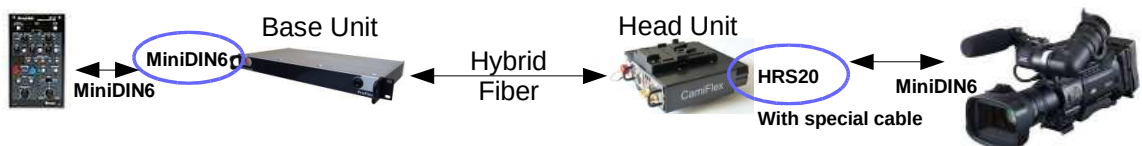

3.12 Remote – LANC (Remote 4)

LANC remote communication is available thought the system:

A specific cable must be used on Head Unit side and power is available to power the remote on Base Unit side.

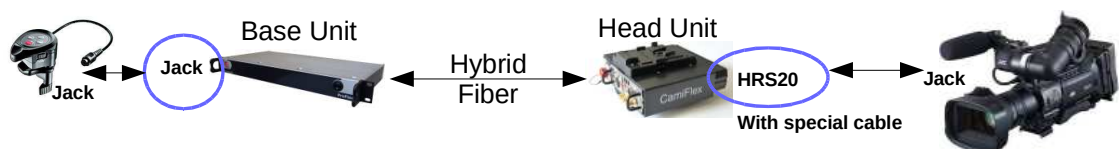

4 Pinout Connectors

4.1 Base Unit – Pinout Connectors

4.1.1 Base Unit – Remote 1 – Serial connection

Remote connection is managed through RS232 or RS-422.

For RS-232 configuration a short-circuit must be done between Pin 4 & Ground (Pin 1 or Pin5).

Baud rate can be up to 700K baud without any specific configuration.



	SubD9-F - Remote RS-232		SubD9-F - Remote RS-422(*)
1	- (Do not used)	1	Ground
2	OUT : TxD	2	OUT : RS_TX-
3	IN : TxD	3	IN : RS_RX+
4	RS-4xx (short-circuit to ground)	4	- (Do not used)
5	Ground	5	Ground
6	- (Do not used)	6	OUT : RS_TX+
7	- (Do not used)	7	- (Do not used)
8	- (Do not used)	8	IN : RS_RX-
9	- (Do not used) → +12V	9	+12V

* Note: Differential RS-422 inputs includes 120R termination resistors

4.1.2 Base Unit – Remote 2 – Ethernet (USB on HeadUnit)

Ethernet (RJ45) is used to connect a Host to the camera thanks to USB connectivity on camera.

4.1.3 Base Unit – Remote 3 – Serial connection

Serial control can be sent through RS-232(TTL level). Baud rate can be up to 9600 baud.

	MiniDIN 6p-F - Remote RS232 (TTL level)
1	Ground
2	IN : RS3_RM/CTL
3	Ground
4	OUT : RS3_SID2
5	IN : RS3_SID1
6	OUT : +12V

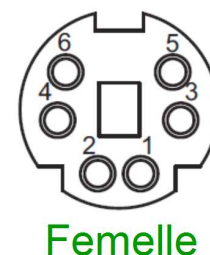

4.1.4 Base Unit – Remote 4 – LANC – Serial connection

Bi-directional serial communication compliant with LANC protocol (9600 baud)

	Mini Jack 2.5mm 3p - LANC
1	LANC
2	+6V
3	GND



4.1.5 Base Unit – Tally connection

Tally input pins need to be short-circuit with ground to turn ON the Tally LED:

- Tally A : Red light
- Tally B : Yellow light
- Both Tally A&B : Red light

	SubD9-M – Tally (A&B)
1	No Connection
2	No Connection
3	No Connection
4	No Connection
5	No Connection
6	Tally A – Red
7	Ground
8	Tally B – Yellow
9	No Connection



4.1.6 Base Unit – Intercom IN connection

Standard XLR 3p connection:

	XLR 3p-F – Intercom IN (Line level)
1	GND
2	IN+
3	IN-



4.1.7 Base Unit – Intercom OUT connection

Standard XLR 3p connection:

	XLR 3p-M – Intercom OUT (Line level)
1	GND
2	OUT+
3	OUT-



4.1.8 Base Unit – Headset IN/OUT connection

	XLR 5p-F – Headset IN/OUT (Line level)
1	GND
2	OUT+
3	OUT-
4	IN+
5	IN-



4.2 Head Unit – Pinout Connectors

4.2.1 Head Unit – Remote/USB/LANC connections

Hirose 20p-F – Remote		
1	IN : - RS1_422_RX-	
2	IN : RS1_232_RX RS1_422_RX+	
3	OUT : RS1_232_TX RS1_422_TX-	
4	OUT : - RS1_422_TX+	
5	IN : GND or No connection	RS-232: short-circuit to GND configuration for RS1
6	Ground	
7	Ground	
8	Ground	
9	OUT : RS3_SID1	
10	IN : RS3_SID2	
11	IN : GND or No connection	RS-232: short-circuit to GND configuration for RS2
12	LANC_Power	
13	Ground	
14	Ground	
15	OUT : RS3_RM/CTL	
16	LANC	
17	USB GND	
18	USB VCC	
19	USB Data +	
20	USB Data -	

4.2.2 Head Unit – Intercom IN/OUT connection

	Hirose 6p-F – Intercom IN/OUT (Line level)
1	GND
2	IN+
3	IN-
4	GND
5	OUT+
6	OUT-



4.2.3 Head Unit – Headset IN/OUT connection

	XLR 5p-F – Headset IN/OUT
1	GND
2	Micro
3	GND
4	L+
5	R+



4.2.4 Head Unit – DC IN connection

	Hirose 4p-F – DC IN
1	Ground
2	Ground
3	From +8V to +24V IN
4	From +8V to +24V IN

External power



4.2.5 Head Unit – DC OUT for Camera connection

	Hirose 5p-F – DC OUT
1	GND
2	GND
3	V+
4	V+
5	NC for V+ = 12Volts out / GND for V+ = 13,2Volts out



4.2.6 Head Unit – external Tally connection in front of Head Unit

	Jack 3.5mm – external Tally
1	GND (not used)
2	GPO (grounded when turn ON LED)
3	+5V out (protected with Fuse)

Recommended schematics:

Max current : 100mA

R depend on LED specification

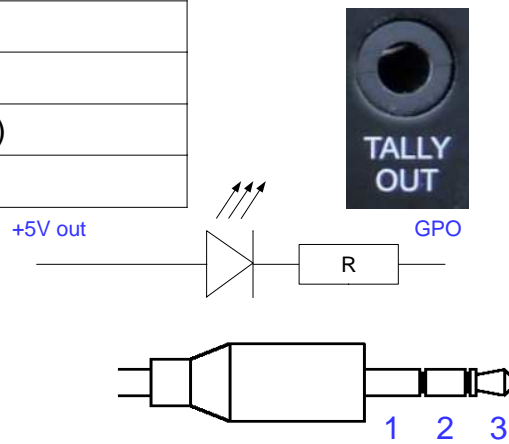

5 Technical specifications

5.1 Power

Physical characteristics (Base Unit case)

1U 19" rugged stainless steel, 280mm depth
Power consumption: <230W with FAN cooling

Operating temperature: +5 ° C to +40 ° C.

Weight: around 3 kg.

Base Unit - Power supply

100-240V AC 50/60Hz (IEC 320 C14)
Unipolar fuse protection is F4AH 5x20 IEC 127.
The mechanical ground of the equipment must be grounded.

Physical characteristics (Head Unit case)

175mm x 215mm x 42mm, with Kodak holder
screw on bottom and tripod lock on top

Power consumption: <10W

Operating temperature: +5 ° C to +40 ° C.

Weight for Lite version: 2 kg approx.

Head Unit - Power supply

By Hybrid fiber or external DC IN :
→ from +8V to +24V <10W

Head Unit - DC Out :

- Max 40W (13.2V)

5.2 Video input and output

SDI Input:

- SD, HD and 3G SDI up to 3 Gbit/s
- Automatic detection of video format
- Cable Equalization up to 100m in 3G-SDI
- 800mVcc nominal level, 500mVcc minimal
- BNC, 75Ω impedance

Loop output:

- Copy of the input signal with cable equalization
- BNC, 75Ω impedance
- Nominal Level: 800mV ± 10%

SDI output (SD, HD and 3G):

- SD, HD and 3G SDI up to 3 Gbit/s
- 3G-SDI : 2,970Gbit/s (2,970/1,001) – SMPTE 424M
- HD-SDI : 1,485Gbit/s (1,485/1,001) – SMPTE292M
- SDI : 270Mbit/s – SMPTE259M
- BNC, 75Ω impedance
- Nominal level: 800mV ± 10%

CVBS analog input (SD only):

- PAL & NTSC compliant
- BNC, 75Ω impedance
- Nominal Level: 1V (700mV + sync 300mV)
- Automatic detection of video format
- Automatic gain correction based on the sync pulse (accept a level change of 50 to 160 %)

CVBS analog output (SD only):

- BNC, 75Ω impedance
- Nominal Level: 1V (700mV + sync 300mV)



5.3 Video signaling

LEDs are present near the video connectors.

- Green means valid video signal presence and locked
- Off means no or invalid signal

5.4 Audio/Remote

Head Unit Audio - Headset

Use dynamic microphone

Max input level : -30dBu (25 mV rms)

All headset impedance are allowed.

Audio - Intercom

4 wires - Line level (+22dBm) - 2 wires not supported

- Audio Level: +24dB maximum (+24dBu = 0dBfs)
- Bandwidth : 20Hz - 20kHz \pm 0,1 dB
- Input : 10k Ω , couplage AC
- Output : 50 Ω

Remote 1

Signals RS-232/RS422 are compliant with standard

Warning: on Base Unit, the SubD9 connector provide +12V DC to power the remote, so direct connection to a computer is not possible.

Remote 2

Compliant with USB2 standard

Remote 3

RS-232 with TTL level (+5V)

Warning: on Base Unit, the MiniDIN connector provide +12V DC to power the remote.

Remote LANC

LANC with TTL level (+5V)

Warning: on Base Unit, the MiniJack connector provide +6V DC to power the remote.

Power Remote on Base Unit

Total current for all remotes power must not exceed 0.7A

END OF DOCUMENT